

Mitsubishi Programmable Controller

Transition from MELSEC-AnS/QnAS (Small Type) Series to Q Series Handbook

(Fundamentals)





Feb. 2015 Edition

● SAFETY PRECAUTIONS ●

(Read these precautions before using this product.)

Before using products introduced in this publication, please read relevant manuals and replacement handbooks carefully and pay full attention to safety to handle the product correctly.

In this publication, the safety precautions are classified into two levels:

" WARNING" and " CAUTION".



Indicates that incorrect handling may cause hazardous conditions, resulting in death or severe injury.



Indicates that incorrect handling may cause hazardous conditions, resulting in minor or moderate injury or property damage.

Under some circumstances, failure to observe the precautions given under " CAUTION" may lead to serious consequences.

Observe the precautions of both levels because they are important for personal and system safety. Make sure that the end users read this publication and keep it in a safe place for future reference.

[Design Precautions]

WARNING

- Configure safety circuits external to the programmable controller to ensure that the entire system operates safely even when a fault occurs in the external power supply or the programmable controller. Failure to do so may result in an accident due to an incorrect output or malfunction.
 - (1) Configure external safety circuits, such as an emergency stop circuit, protection circuit, and protective interlock circuit for forward/reverse operation or upper/lower limit positioning.
 - (2) The programmable controller stops its operation upon detection of the following status, and the output status of the system will be as shown below.

	Q series module	A series module
Overcurrent or overvoltage protection of the power supply module is activated.	All outputs are turned off	All outputs are turned off
The CPU module detects an error such as a watchdog timer error by the self-diagnostic function.	All outputs are held or turned off according to the parameter setting.	All outputs are turned off

All outputs may turn on when an error occurs in the part, such as I/O control part, where the CPU module cannot detect any error. To ensure safety operation in such a case, provide a safety mechanism or a fail-safe circuit external to the programmable controller. For a fail-safe circuit example, refer to General Safety Requirements in the QCPU User's Manual (Hardware Design, Maintenance and Inspection).

- (3) Outputs may remain on or off due to a failure of an output module relay or transistor. Configure an external circuit for monitoring output signals that could cause a serious accident.

[Design Precautions]

WARNING

- In an output module, when a load current exceeding the rated current or an overcurrent caused by a load short-circuit flows for a long time, it may cause smoke and fire. To prevent this, configure an external safety circuit, such as a fuse.
- Configure a circuit so that the programmable controller is turned on first and then the external power supply.
If the external power supply is turned on first, an accident may occur due to an incorrect output or malfunction.
- For the operating status of each station after a communication failure, refer to relevant manuals for the network.
Incorrect output or malfunction due to a communication failure may result in an accident.
- When changing data of the running programmable controller from a peripheral connected to the CPU module or from a personal computer connected to an intelligent function module/special function module, configure an interlock circuit in the sequence program to ensure that the entire system will always operate safely.
For other forms of control (such as program modification or operating status change) of a running programmable controller, read the relevant manuals carefully and ensure that the operation is safe before proceeding.
Especially, in the case of a control from an external device to a remote programmable controller, immediate action cannot be taken for a problem on the programmable controller due to a communication failure.
To prevent this, configure an interlock circuit in the sequence program, and determine corrective actions to be taken between the external device and CPU module in case of a communication failure.

CAUTION

- Do not install the control lines or communication cables together with the main circuit lines or power cables.
Keep a distance of 100mm (3.94 inches) or more between them.
Failure to do so may result in malfunction due to noise.
- When a device such as a lamp, heater, or solenoid valve is controlled through an output module, a large current (approximately ten times greater than normal) may flow when the output is turned from off to on.
Take measures such as replacing the module with one having a sufficient current rating.
- After the CPU module is powered on or is reset, the time taken to enter the RUN status varies depending on the system configuration, parameter settings, and/or program size. Design circuits so that the entire system will always operate safely, regardless of the time.

[Installation Precautions]

CAUTION

- Use the programmable controller in an environment that meets the general specifications in the QCPU User's Manual (Hardware Design, Maintenance and Inspection).
Failure to do so may result in electric shock, fire, malfunction, or damage to or deterioration of the product.
- To mount the module, while pressing the module mounting lever located in the lower part of the module, fully insert the module fixing projection(s) into the hole(s) in the base unit and press the module until it snaps into place.
Incorrect mounting may cause malfunction, failure or drop of the module.
When using the programmable controller in an environment of frequent vibrations, fix the module with a screw.
Tighten the screw within the specified torque range.
Undertightening can cause drop of the screw, short circuit or malfunction.
Overtightening can damage the screw and/or module, resulting in drop, short circuit, or malfunction.
- When using an extension cable, connect it to the extension cable connector of the base unit securely.
Check the connection for looseness.
Poor contact may cause incorrect input or output.
- When using a memory card, fully insert it into the memory card slot.
Check that it is inserted completely.
Poor contact may cause malfunction.
- When using an SD memory card, fully insert it into the SD memory card slot. Check that it is inserted completely. Poor contact may cause malfunction.
- Securely insert an extended SRAM cassette into the cassette connector of the CPU module. After insertion, close the cassette cover to prevent the cassette from coming off. Poor contact may cause malfunction.
- Shut off the external power supply for the system in all phases before mounting or removing the module. Failure to do so may result in damage to the product.
A module can be replaced online (while power is on) on any MELSECNET/H remote I/O station or in the system where a CPU module supporting the online module change function is used.
Note that there are restrictions on the modules that can be replaced online, and each module has its predetermined replacement procedure.
For details, refer to the relevant sections in the QCPU User's Manual (Hardware Design, Maintenance and Inspection) and in the manual for the corresponding module.
- Do not directly touch any conductive parts and electronic components of the module, memory card, SD memory card, or extended SRAM cassette. Doing so can cause malfunction or failure of the module.
- When using a Motion CPU module and modules designed for motion control, check that the combinations of these modules are correct before applying power. The modules may be damaged if the combination is incorrect. For details, refer to the user's manual for the Motion CPU module.

[Wiring Precautions]

WARNING

- Shut off the external power supply for the system in all phases before wiring.
Failure to do so may result in electric shock or damage to the product.
- After wiring, attach the included terminal cover to the module before turning it on for operation.
Failure to do so may result in electric shock.

CAUTION

- Individually ground the FG and LG terminals of the programmable controller with a ground resistance of 100 ohms or less. Failure to do so may result in electric shock or malfunction.
- Use applicable solderless terminals and tighten them within the specified torque range. If any spade solderless terminal is used, it may be disconnected when the terminal screw comes loose, resulting in failure.
- Check the rated voltage and terminal layout before wiring to the module, and connect the cables correctly.
Connecting a power supply with a different voltage rating or incorrect wiring may cause a fire or failure.
- Connectors for external connection must be crimped or pressed with the tool specified by the manufacturer, or must be correctly soldered.
Incomplete connections could result in short circuit, fire, or malfunction.
- Securely connect the connector to the module. Poor contact may cause malfunction.
- Do not install the control lines or communication cables together with the main circuit lines or power cables. Keep a distance of 100mm or more between them. Failure to do so may result in malfunction due to noise.
- Place the cables in a duct or clamp them. If not, dangling cable may swing or inadvertently be pulled, resulting in damage to the module or cables or malfunction due to poor contact.
- Check the interface type and correctly connect the cable. Incorrect wiring (connecting the cable to an incorrect interface) may cause failure of the module and external device.
- Tighten the terminal screw within the specified torque range.
Undertightening can cause short circuit, fire, or malfunction.
Overtightening can damage the screw and/or module, resulting in drop, short circuit, or malfunction.
- Prevent foreign matter such as dust or wire chips from entering the module.
Such foreign matter can cause a fire, failure, or malfunction.
- A protective film is attached to the top of the module to prevent foreign matter, such as wire chips, from entering the module during wiring.
Do not remove the film during wiring.
Remove it for heat dissipation before system operation.

[Wiring Precautions]

CAUTION

- When disconnecting the cable from the module, do not pull the cable by the cable part. For the cable with connector, hold the connector part of the cable. For the cable connected to the terminal block, loosen the terminal screw. Pulling the cable connected to the module may result in malfunction or damage to the module or cable.
- Mitsubishi programmable controllers must be installed in control panels.
Connect the main power supply to the power supply module in the control panel through a relay terminal block.
Wiring and replacement of a power supply module must be performed by maintenance personnel who is familiar with protection against electric shock. (For wiring methods, refer to the QCPU User's Manual (Hardware Design, Maintenance and Inspection)).

[Startup and Maintenance Precautions]

WARNING

- Do not touch any terminal while power is on.
Doing so will cause electric shock or malfunction.
- Correctly connect the battery connector.
Do not charge, disassemble, heat, short-circuit, solder, or throw the battery into the fire. Also, do not expose it to liquid or strong shock. Doing so will cause the battery to produce heat, explode, ignite, or leak, resulting in injury and fire.
- Shut off the external power supply for the system in all phases before cleaning the module or retightening the terminal screws or module fixing screws.
Failure to do so may result in electric shock.

CAUTION

- Before performing online operations (especially, program modification, forced output, and operation status change) for the running CPU module from the peripheral connected, read relevant manuals carefully and ensure the safety.
Improper operation may damage machines or cause accidents.
- Do not disassemble or modify the modules.
Doing so may cause failure, malfunction, injury, or a fire.
- Use any radio communication device such as a cellular phone or PHS (Personal Handy-phone System) more than 25cm (9.85 inches) away in all directions from the programmable controller.
Failure to do so may cause malfunction.
- Shut off the external power supply for the system in all phases before mounting or removing the module. Failure to do so may cause the module to fail or malfunction.
A module can be replaced online (while power is on) on any MELSECNET/H remote I/O station or in the system where a CPU module supporting the online module change function is used.
Note that there are restrictions on the modules that can be replaced online, and each module has its predetermined replacement procedure.
For details, refer to the relevant sections in the QCPU User's Manual (Hardware Design, Maintenance and Inspection) and in the manual for the corresponding module.

[Startup and Maintenance Precautions]

CAUTION

- After the first use of the product, do not mount/remove the module to/from the base unit, and the terminal block to/from the module, and do not insert/remove the extended SRAM cassette to/from the CPU module more than 50 times (IEC 61131-2 compliant) respectively. Exceeding the limit may cause malfunction.
- After the first use of the product, do not insert/remove the SD memory card to/from the CPU module more than 500 times. Exceeding the limit may cause malfunction.
- Do not drop or apply shock to the battery to be installed in the module.
Doing so may damage the battery, causing the battery fluid to leak inside the battery.
If the battery is dropped or any shock is applied to it, dispose of it without using.
- Before handling the module, touch a grounded metal object to discharge the static electricity from the human body.
Failure to do so may cause the module to fail or malfunction.

[Disposal Precautions]

CAUTION

- When disposing of this product, treat it as industrial waste.
When disposing of batteries, separate them from other wastes according to the local regulations.
(For details of the battery directive in EU member states, refer to the QCPU User's Manual (Hardware Design, Maintenance and Inspection).)

[Transportation Precautions]

CAUTION

- When transporting lithium batteries, follow the transportation regulations.
(For details of the regulated models, refer to the QCPU User's Manual (Hardware Design, Maintenance and Inspection).)

● CONDITIONS OF USE FOR THE PRODUCT ●

- (1) Mitsubishi programmable controller ("the PRODUCT") shall be used in conditions;
- i) where any problem, fault or failure occurring in the PRODUCT, if any, shall not lead to any major or serious accident; and
 - ii) where the backup and fail-safe function are systematically or automatically provided outside of the PRODUCT for the case of any problem, fault or failure occurring in the PRODUCT.

- (2) The PRODUCT has been designed and manufactured for the purpose of being used in general industries.

MITSUBISHI SHALL HAVE NO RESPONSIBILITY OR LIABILITY (INCLUDING, BUT NOT LIMITED TO ANY AND ALL RESPONSIBILITY OR LIABILITY BASED ON CONTRACT, WARRANTY, TORT, PRODUCT LIABILITY) FOR ANY INJURY OR DEATH TO PERSONS OR LOSS OR DAMAGE TO PROPERTY CAUSED BY the PRODUCT THAT ARE OPERATED OR USED IN APPLICATION NOT INTENDED OR EXCLUDED BY INSTRUCTIONS, PRECAUTIONS, OR WARNING CONTAINED IN MITSUBISHI'S USER, INSTRUCTION AND/OR SAFETY MANUALS, TECHNICAL BULLETINS AND GUIDELINES FOR the PRODUCT.

("Prohibited Application")

Prohibited Applications include, but not limited to, the use of the PRODUCT in;

- Nuclear Power Plants and any other power plants operated by Power companies, and/or any other cases in which the public could be affected if any problem or fault occurs in the PRODUCT.
- Railway companies or Public service purposes, and/or any other cases in which establishment of a special quality assurance system is required by the Purchaser or End User.
- Aircraft or Aerospace, Medical applications, Train equipment, transport equipment such as Elevator and Escalator, Incineration and Fuel devices, Vehicles, Manned transportation, Equipment for Recreation and Amusement, and Safety devices, handling of Nuclear or Hazardous Materials or Chemicals, Mining and Drilling, and/or other applications where there is a significant risk of injury to the public or property.

Notwithstanding the above, restrictions Mitsubishi may in its sole discretion, authorize use of the PRODUCT in one or more of the Prohibited Applications, provided that the usage of the PRODUCT is limited only for the specific applications agreed to by Mitsubishi and provided further that no special quality assurance or fail-safe, redundant or other safety features which exceed the general specifications of the PRODUCTS are required. For details, please contact the Mitsubishi representative in your region.

REVISIONS

* The handbook number is given on the bottom left of the back cover.

Print Date	* Handbook Number	Revision
Nov., 2011	L(NA)08219ENG-A	First edition
Feb., 2015	L(NA)08219ENG-B	Overall revision with the addition of the Universal model QCPU <u>Addition of modules to be replaced</u> QA1S51B, Q03UDVCPU, Q04UDVCPU, Q06UDVCPU, Q13UDVCPU, Q26UDVCPU, AnS size Q series large type base unit, QA1S6ADP <u>Addition</u> Section 5.1.2 <u>Change</u> Chapter 8 to Appendix 1, Appendix1 to Appendix 2, Appendix 2 to Appendix 3, Appendix 3 to Appendix 4 <u>Partial correction</u> SAFETY PRECAUTIONS, GENERIC TERMS AND ABBREVIATIONS, Section 1.1, 1.2, Chapter 2, 3, 5, 6, Section 7.1.2

Japanese Handbook Version L08209-E

This handbook confers no industrial property rights or any rights of any other kind, nor does it confer any patent licenses. Mitsubishi Electric Corporation cannot be held responsible for any problems involving industrial property rights which may occur as a result of using the contents noted in this handbook.

CONTENTS

SAFETY PRECAUTIONS	A - 1
CONDITIONS OF USE FOR THE PRODUCT	A - 7
REVISIONS	A - 8
GENERIC TERMS AND ABBREVIATIONS	A - 13

CHAPTER 1 INTRODUCTION	1 - 1 to 1 - 14
-------------------------------	------------------------

1.1 Considerations before Selection of Alternative Models for Replacement	1 - 1
1.2 Suggestions for Transition from the AnS/QnAS (Small Type) Series to the Q Series	1 - 3
1.2.1 Advantages of transition to Q series	1 - 3
1.2.2 Suggestions for transition to Q series	1 - 4
1.2.3 Precautions for transition	1 - 13

CHAPTER 2 REPLACEMENT OF CPU MODULE	2 - 1 to 2 - 36
--	------------------------

2.1 List of Alternative Models of CPU Module	2 - 1
2.2 Comparison of CPU Module Specifications	2 - 10
2.3 Functional Comparison of CPU Module	2 - 20
2.3.1 Functional comparison between AnS series and Q series	2 - 20
2.3.2 Functional comparison between QnAS series and Q series	2 - 24
2.4 Precautions for CPU Module Replacement	2 - 28
2.4.1 Memory for CPU module	2 - 28
2.4.2 Keyword registration and password registration	2 - 31
2.4.3 Write during RUN	2 - 31
2.4.4 Number of slots on the base unit	2 - 32
2.4.5 Base unit compatible with QCPU	2 - 34
2.4.6 Programming tool and connection cable for Q series CPU	2 - 36

CHAPTER 3 REPLACEMENT OF I/O MODULE	3 - 1 to 3 - 89
--	------------------------

3.1 List of Alternative Models of I/O Module	3 - 1
3.2 Comparison of I/O Module Specifications	3 - 13
3.2.1 Comparison of input module specifications	3 - 13
3.2.2 Comparison of output module specifications	3 - 47
3.2.3 Comparison of I/O combined module specifications	3 - 70
3.2.4 Comparison of interrupt module specifications	3 - 86
3.2.5 Comparison of blank cover and dummy module specifications	3 - 87
3.3 Precautions for I/O Module Replacement	3 - 88

CHAPTER 4 REPLACEMENT OF POWER SUPPLY MODULE	4 - 1 to 4 - 7
---	-----------------------

4.1 List of Alternative Models of Power Supply Module	4 - 1
4.2 Comparison of Power Supply Module Specifications	4 - 2
4.3 Precautions for Power Supply Module Replacement	4 - 7

CHAPTER 5 REPLACEMENT OF BASE UNIT AND EXTENSION CABLE 5 - 1 to 5 - 20

5.1	List of Alternative Models of Base Unit and Extension Cable	5 - 1
5.1.1	List of alternative models of base unit	5 - 1
5.1.2	List of alternative models of AnS size Q series large type base unit	5 - 2
5.1.3	List of alternative models of extension cable	5 - 2
5.2	Comparison of Base Unit and Extension Cable Specifications	5 - 3
5.2.1	Comparison of base unit specifications	5 - 3
5.2.2	Comparison of extension cable specifications	5 - 8
5.3	Precautions for Replacement of Base Unit and Extension Cable	5 - 9
5.3.1	Precautions for replacement of base unit	5 - 9
5.3.2	Precautions for replacement of extension cable	5 - 10
5.4	QA(1S) Extension Base Unit	5 - 11
5.4.1	QA(1S) extension base unit specifications	5 - 11
5.4.2	Applicable QCPU	5 - 11
5.4.3	Extension cable	5 - 12
5.4.4	System configuration	5 - 12
5.4.5	System equipment list	5 - 14
5.4.6	I/O address for the QA(1S) extension base unit	5 - 16
5.5	AnS Size Q Series Large Type Base Unit	5 - 18
5.5.1	Specifications	5 - 18
5.5.2	Applicable programmable controller	5 - 20
5.5.3	Modules that cannot be mounted on the AnS size Q series large type base unit	5 - 20

CHAPTER 6 MEMORY AND BATTERY REPLACEMENT 6 - 1 to 6 - 3

6.1	List of Alternative Models for Memory	6 - 1
6.2	Precautions for Memory and Battery Replacement	6 - 2

CHAPTER 7 REPLACEMENT OF PROGRAM 7 - 1 to 7 - 52

7.1	Program Replacement Procedure	7 - 5
7.1.1	Program conversion procedure from AnS/QnASCPU to QCPU	7 - 5
7.1.2	Changing programmable controller type	7 - 7
7.1.3	AnSCPU program conversion ratio	7 - 10
7.1.4	Reading (Reusing) other format files	7 - 12
7.2	Instruction Conversion	7 - 15
7.2.1	List of instructions conversion from AnSCPU to QCPU (Sequence/Basic/Application instructions)	7 - 15
7.2.2	List of instruction conversion from AnSCPU to QCPU (Dedicated instructions)	7 - 20
7.2.3	Instructions that may need a replacement at instruction conversion from AnSCPU to QCPU	7 - 23
7.2.4	Instruction conversion from QnASCPU to QCPU	7 - 27
7.2.5	Instructions that may need a replacement after conversion from QnASCPU to QCPU	7 - 28
7.3	Precautions for Replacement of Parameter	7 - 29
7.3.1	Conversion from AnSCPU to QCPU	7 - 29
7.3.2	Conversion from QnASCPU to QCPU	7 - 31

7.4	Replacement of Special Relay	7 - 33
7.4.1	Replacing the AnSCPU with the QCPU	7 - 33
7.4.2	Replacing the QnASCPU with the QCPU	7 - 33
7.5	Replacement of Special Register	7 - 34
7.5.1	Replacing the AnSCPU with the QCPU	7 - 34
7.5.2	Replacing the QnASCPU with the QCPU	7 - 34
7.6	Precautions for Replacement of the MELSAP-II with the MELSAP3	7 - 35
7.6.1	Starting SFC program	7 - 35
7.6.2	Block information (SFC information device)	7 - 35
7.6.3	Specifications comparison between MELSAP-II and MELSAP3	7 - 36
7.6.4	MELSAP3 specifications comparison between QnASCPU and QCPU	7 - 37
7.6.5	SFC diagram that cannot be read normally in another format	7 - 38
7.7	Precautions for Program Replacement	7 - 39
7.7.1	List of applicable devices	7 - 39
7.7.2	I/O control method	7 - 42
7.7.3	Usable data format for instructions	7 - 42
7.7.4	Timer	7 - 43
7.7.5	Counter	7 - 44
7.7.6	Display instructions	7 - 44
7.7.7	Index register	7 - 44
7.7.8	Instructions where format is changed (Excluding AnUSCPU dedicated instructions)	7 - 46
7.7.9	AnUSCPU dedicated instruction	7 - 47
7.7.10	Setting method when multiple sequence programs are created	7 - 48
7.7.11	Precautions for file register replacement	7 - 50
7.7.12	Boot run method (Writing programs to ROM)	7 - 51

APPENDICES**App - 1 to App - 17**

Appendix 1	External Dimensions	App - 1
Appendix 2	Basic Model QCPU	App - 1
Appendix 2.1	Major restrictions	App - 1
Appendix 2.2	CPU module specifications comparison	App - 3
Appendix 2.3	CPU module functional comparison	App - 5
Appendix 3	Spare Parts Storage	App - 11
Appendix 4	Related Manuals	App - 12
Appendix 4.1	Materials for replacement	App - 12
Appendix 4.2	AnS/QnAS series	App - 14
Appendix 4.3	Q series	App - 16
Appendix 4.4	Programming tool	App - 17
Appendix 4.5	Products manufactured by Mitsubishi Electric Engineering Co., Ltd.	App - 17
Appendix 4.6	Products manufactured by Mitsubishi Electric System & Service Co., Ltd.	App - 17

- For the products shown in handbooks for transition, Catalogue, and transition examples, refer to the manuals for the relevant products and check the detailed specifications, precautions for use, and restrictions before replacement.

For the products manufactured by Mitsubishi Electric Engineering Co., Ltd., Mitsubishi Electric System & Service Co., Ltd., and other companies, refer to the catalogue for each product and check the detailed specifications, precautions for use, and restrictions before use.

The manuals and catalogues for our products, products manufactured by Mitsubishi Electric Engineering Co., Ltd., and Mitsubishi Electric System & Service Co., Ltd., are shown in Appendix of each handbook for transition.

- For details on product compliance with the above standards, please contact your local Mitsubishi Electric sales office or representative.
- Products shown in this handbook are subject to change without notice.

GENERIC TERMS AND ABBREVIATIONS

Unless otherwise specified, this handbook uses the following generic terms and abbreviations.

Generic term/abbreviation	Description
■ Series	
A series	Abbreviation for large types of Mitsubishi MELSEC-A series programmable controllers
AnS series	Abbreviation for compact types of Mitsubishi MELSEC-A series programmable controllers
A/AnS series	Generic term for A series and AnS series
QnA series	Abbreviation for large types of Mitsubishi MELSEC-QnA series programmable controllers
QnAS series	Abbreviation for compact types of Mitsubishi MELSEC-QnA series programmable controllers
QnA/QnAS series	Generic term for QnA series and QnAS series
A/AnS/QnA/QnAS series	Generic term for A series, AnS series, QnA series, and QnAS series
Q series	Abbreviation for Mitsubishi MELSEC-Q series programmable controllers
■ CPU module type	
CPU module	Generic term for A series, AnS series, QnA series, QnAS series, and Q series CPU modules
Basic model QCPU	Generic term for the Q00JCPU, Q00CPU, and Q01CPU
High Performance model QCPU	Generic term for the Q02CPU, Q02HCPU, Q06HCPU, Q12HCPU, and Q25HCPU * This handbook mainly explains about the Q02CPU, Q02HCPU, Q06HCPU, and Q12HCPU.
Process CPU	Generic term for the Q02PHCPU, Q06PHCPU, Q12PHCPU, and Q25PHCPU
Redundant CPU	Generic term for the Q12PRHCPU and Q25PRHCPU
Universal model QCPU	Generic term for the Q00UJCPU, Q00UCPU, Q01UCPU, Q02UCPU, Q03UDCPU, Q03UDVCPU, Q03UDECPU, Q04UDHCPU, Q04UDVCPU, Q04UDEHCPU, Q06UDHCPU, Q06UDVCPU, Q06UDEHCPU, Q10UDHCPU, Q10UDEHCPU, Q13UDHCPU, Q13UDVCPU, Q13UDEHCPU, Q20UDHCPU, Q20UDEHCPU, Q26UDHCPU, Q26UDVCPU, Q26UDEHCPU, Q50UDEHCPU, and Q100UDEHCPU * This handbook mainly explains about the Q00UJCPU, Q00UCPU, Q01UCPU, Q02UCPU, Q03UDCPU, Q04UDHCPU, and Q06UDHCPU, which can replace the AnS/QnAS series. The specifications and functions of the Q10UDEHCPU to Q100UDEHCPU are the same as those of the modules described above, although the program and memory capacities increase.
■ CPU module model	
ACPU	Generic term for MELSEC-A series CPU modules
AnSCPU	Generic term for MELSEC-AnS series CPU modules
AnNCPU	Generic term for the A1NCPUP21/R21, A1NCPUP21-S3, A2NCPUP21/R21, A2NCPUP21-S3(S4), A3NCPUP21/R21, and A3NCPUP21-S3
AnACPU	Generic term for the A2ACPU, A2ACPU-S1, A3ACPU, A2ACPUP21/R21, A2ACPUP21/R21-S1, and A3ACPUP21/R21
AnUCPU	Generic term for the A2UCPU, A2UCPU-S1, A3UCPU, and A4UCPU
AnUS(H)CPU	Generic term for the A2USCPU, A2USCPU-S1, and A2USHCPU-S1
A/AnSCPU	Generic term for the ACPUP21/R21 and AnSCPUP21/R21
AnN/AnACPU	Generic term for the AnNCPUP21/R21 and AnACPUP21/R21
AnN/AnA/AnSCPU	Generic term for the AnNCPUP21/R21, AnACPUP21/R21, and AnSCPUP21/R21
QnACPU	Generic term for MELSEC-QnA series CPU modules
QnASCPU	Generic term for MELSEC-QnAS series CPU modules
QnA/QnASCPU	Generic term for the QnACPU and QnASCPU
A/AnS/QnA/QnASCPU	Generic term for the ACPUP21/R21, AnSCPUP21/R21, QnACPUP21/R21, and QnASCPUP21/R21
QCPU	Generic term for MELSEC-Q series CPU modules

1 INTRODUCTION

1.1 Considerations before Selection of Alternative Models for Replacement

This transition handbook describes the model selection of CPU modules and I/O modules after replacing models, for the transition from the MELSEC-AnS/QnAS series to the Q series.

At the transition from MELSEC-AnS/QnAS series to Q series, some items such as the replacement procedure, installation location, specifications comparisons between existing modules and replaced modules, and replacement method are required to be considered beforehand.

The following shows major options. Consider them sufficiently in advance. (It is necessary to understand the existing system configuration before making considerations.)

(Major items required to be considered in advance)

1) Replacement methods and installation location

- a) Whether gradual replacement (only the CPU module is replaced with Q series, etc.) or batch replacement for the replacement method of the existing system. When replacing it gradually, which existing modules should be leveraged (left).
- b) Whether some space can be reserved when adding a base unit at the replacement work.

2) Replacement schedule

3) Model selection after replacing models (I/O module)

- a) Whether a module whose specifications (rated input current, etc.) and functions are equivalent to that of the existing module exists or not in the Q series.
- b) Whether utilizing the existing modules continuously or replacing them with Q series modules.
- c) Whether utilizing the existing external wiring or wiring newly.

4) Model selection after replacing models (intelligent function module (analog, high-speed counter module, etc))

- a) Whether the specifications of replaced modules and connection external device match or not.

5) Model selection after replacing models (communication module (computer link module, Ethernet module etc))

- a) Whether the communication target device is compatible with the Q series module commands in the communication using the MC protocol or not.
- b) Whether the communication target device software (program) can be changed to Q series CPU-compatible or not.

6) Model selection after replacing models (network module (MELSECNET (II), MELSECNET/MINI(-S3)))

- a) Whether the replacement of MELSECNET (II) is a gradual replacement or batch replacement for.
- b) Whether local stations and remote stations can be grouped into two networks, PLC-to-PLC network and remote I/O network, by replacing to MELSECNET/H when the local stations and remote stations are mixed in the existing MELSECNET (II).
- c) Whether a new communication cable installation has been considered or not at the replacement from MELSECNET/MINI(-S3) to CC-Link.

7) Program utilization

- a) Whether utilizing the program in the existing system or creating a new program.
- b) Whether the workload and cost of correction have been considered or not when utilizing the program of intelligent function module and communication module (nonprocedural mode).

Point

The purpose of this transition handbook is to how the Universal model QCPU can be used to transition from the MELSEC-AnS/QnAS series.

When the Universal model QCPU is mounted on a QA extension base unit, use the module whose serial number (first five digits) is "13102" or later.

Please refer to the Transition from MELSEC-A/QnA (Large Type) Series to Q Series Handbook (Fundamentals) L(NA)08043ENG for the replacement with a High Performance model QCPU.

1.2 Suggestions for Transition from the AnS/QnAS (Small Type) Series to the Q Series

1.2.1 Advantages of transition to Q series

(1) Advanced performance of equipments (Tact time reduction).

The Q series includes faster operation processing speed, faster bus speed and dual processors of Super MSP (MELSEC SEQUENCE PROCESSOR) and general-purpose processor to provide over 5 times more efficient processing than the AnS series. This realizes more advanced performance of equipments.

(2) Compact control panel and space saving

Comparing to the AnS/QnAS series, the Q series requires 60% mounting area, which allows installing compacter control panel.

(3) Improved maintainability

- (a) The high-speed program ports (Ethernet port, USB port, and high-speed serial port) enable the program reading/writing time to be greatly reduced, resulting in improvement of on-site maintainability.
- (b) The Universal model QCPU does not require the ROM operation because the program memory is the flash ROM. As the standard ROM (flash ROM) is built-in the High Performance model QCPU and Basic model QCPU, the ROM operation can be performed (without battery) without a memory card.
- (c) As large files can be managed, it is possible to store conventional programs as correction history in memory.

(4) Easy support for information systems

The Web server module, MES interface module, and high speed data logger module can perform remote monitoring of programmable controller CPUs and perform data collection for quality control and traceability. Information can be easily gathered from the factory using a Web server module once transition from AnS/QnAS series to Q series has been completed.

1.2.2 Suggestions for transition to Q series

(1) Transition to Q series by utilizing existing wiring

Method : Use the upgrade tool manufactured by Mitsubishi Electric Engineering Co., Ltd. and the existing mounting hole/terminal block wiring.

Advantage: No need to process additional holes, and the existing wiring is usable.

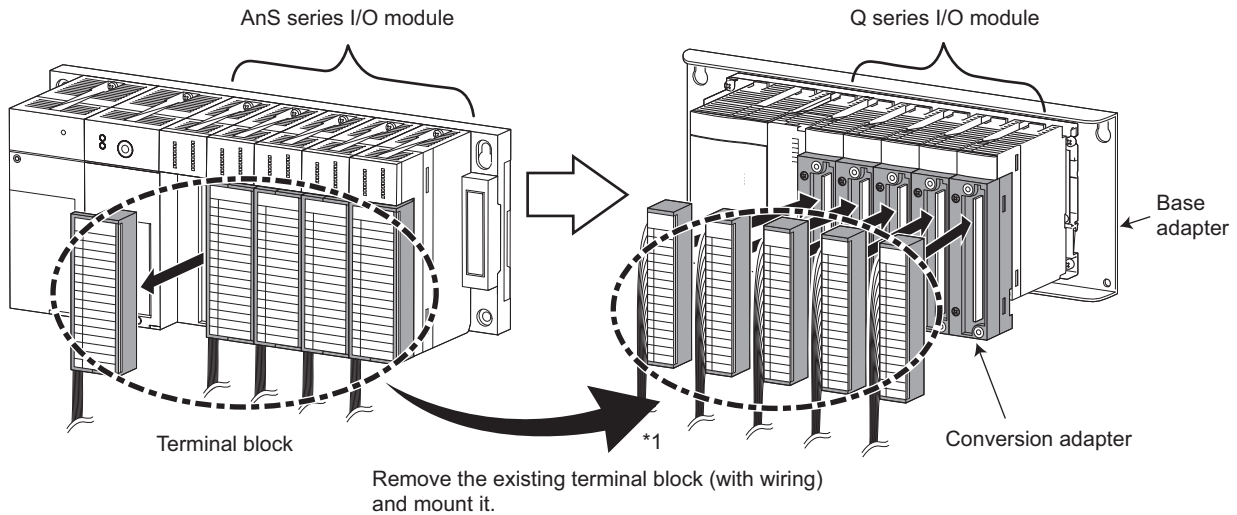

*1 The terminal block cover (from the old terminal block) must be exchanged.

Remarks

- (1) Upgrade tool for transition from the AnS series to the Q series released from Mitsubishi Electric Engineering Co., Ltd. is composed of the following products.
 - Conversion adapter for changing the existing wiring connected to the AnS series I/O module to wiring for the Q series I/O module
 - Base adapter which utilizes the mounting hole of the AnS series base unit for mounting MELSEC-Q series module

For example, using the conversion adapter allows utilizing the wiring connected to the AnS series I/O module for the Q series module without change.

For details, refer to the catalog of the upgrade tool.

- (2) Using outside connection method, the existing wiring for AnS series input/output module connector type is usable. (No need to change the wiring, only move the connector to the Q series module.)
Moreover, it is possible to mount a module used with the upgrade tool on the same base unit.
- (3) When the existing extension base unit is A large type series, refer to the Transition from MELSEC-A/QnA (Large Type) Series to Q Series Handbook (Fundamentals).

Replacement procedures:

- Remove the existing AnS series modules together with the base unit, and use the existing mounting holes to mount the upgrade tool (Base adapter) manufactured by Mitsubishi Electric Engineering Co., Ltd. Then mount the Q series. (By mounting the base adapter, it is not necessary to redo the mounting holes.)

If the existing base unit is mounted on a DIN rail, the replaced Q series base unit can be directed installed, so a base adaptor is unnecessary.

- Mount the upgrade tool (Conversion adapter) manufactured by Mitsubishi Electric Engineering Co., Ltd. on the mounted Q series I/O modules.
- Remove the terminal blocks wired from the existing AnS series I/O modules, and mount the blocks on the conversion adapter. (The existing wiring is usable.)
- Programs are automatically converted* by changing the programmable controller type from AnS/ QnASCPU to QCPU using GX Developer. Even if the module arrangement is changed, the I/O can be assigned to the same number as before, which cuts out the need to modify the programs and slot number for I/O module.

* Some instructions are not automatically converted. In case of intelligent function module or network module, programs and parameters need be changed.

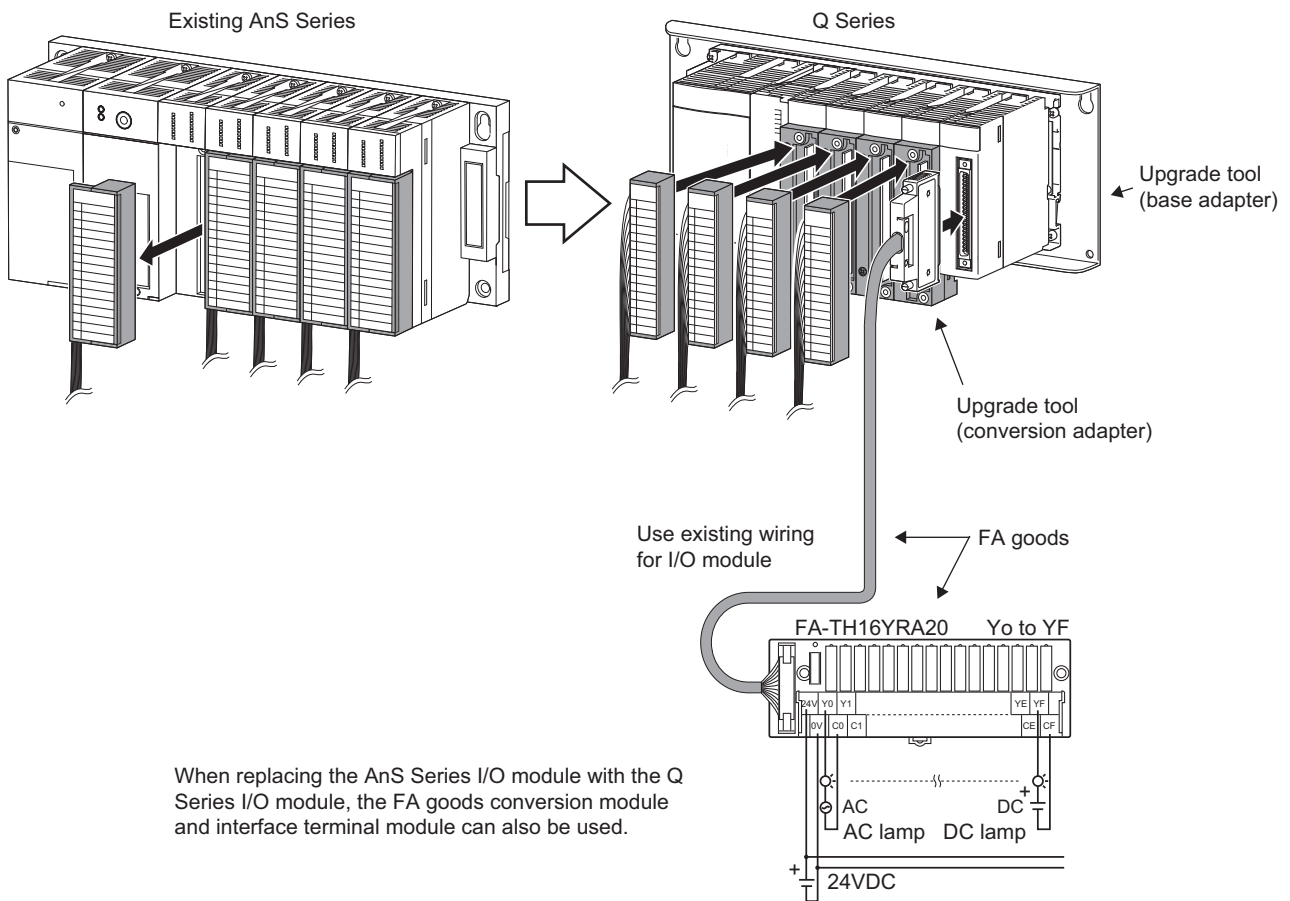

When replacing the AnS Series I/O module with the Q Series I/O module, the FA goods conversion module and interface terminal module can also be used.

■ Upgrade tool list

(a) Conversion adapter

1) 1-slot type

Module type	MELSEC-AnS/QnAS Series module model	MELSEC-Q Series module model	Conversion adapter model ^{*1*2}
Input module	A1SX10, A1SX10EU	QX10	ERNT-ASQTXY10
	A1SX40	QX40, QX70	ERNT-ASQTX40
	A1SX40-S2	QX40	
	A1SX40-S1	QX40-S1	
	A1SX80, A1SX80-S1, A1SX80-S2	QX80	ERNT-ASQTX80
Output module	A1SY10, A1SY10EU	QY10	ERNT-ASQTY10
	A1SY22	QY22	ERNT-ASQTY22
	A1SY40, A1SY40P	QY40P	ERNT-ASQTY40
	A1SY50	QY50	ERNT-ASQTY50
	A1SY80	QY80	ERNT-ASQTY80
	Analog input module	A1S64AD	Q64AD
A1S68AD (voltage input)		Q68ADV	ERNT-ASQT68AD
A1S68AD (current input)		Q68ADI	
A1S68AD		Q68AD-G	ERNT-ASQT68AD-G ^{*3}
Analog output module	A1S62DA	Q62DAN	ERNT-ASQT62DA
	A1S68DAV	Q68DAVN	ERNT-ASQT68DA
	A1S68DAI	Q68DAIN	
Analog input/output module	A1S63ADA	Q64AD2DA	ERNT-ASQT63ADA
Thermocouple input module	A1S68TD	Q68TD-G-H01	ERNT-ASQT68TD-H01 ^{*3}
		Q68TD-G-H02	ERNT-ASQT68TD-H02 ^{*3}
RTD input module	A1S62RD3(N)	Q64RD	ERNT-ASQT62RD
	A1S62RD4(N)		
High-speed counter module	A1SD61	QD62	ERNT-ASQTD61 ^{*3}
		QD62-H01	
		QD62-H02	
	A1SD62	QD62	ERNT-ASQTD62 ^{*3}
	A1SD62E	QD62E	ERNT-ASQTD62D ^{*3}
A1S62D	QD62D	ERNT-ASQTD62D ^{*3}	
Temperature control module	A1S64TCTT-S1	Q64TCTTN	ERNT-ASQT64TCTT
	A1S64TCTRT ^{*4}		
	A1S64TCRT-S1	Q64TCRTN	ERNT-ASQT64TCRT
	A1S64TCTRT ^{*5}		
	A1S62TCTT-S2	Q64TCTTN	ERNT-ASQT62TCTT
	A1S64TCTRT ^{*6}		
	A1S62TCRT-S2	Q64TCRTN	ERNT-ASQT62TCRT
	A1S64TCTRT ^{*7}		

*1 The module mounting slot position differs, so the wiring length must be adjusted.

*2 If the I/O modules are mounted adjacently using the conversion adapter, mounting may not be possible if the existing wires are thick or there are many wires. If the wires interfere, lift the wires up toward the front so they are out of the way. If the wires still interfere, leave one slot open to ensure space for the wires. If the AnS size Q series large type base unit is used, wires do not interfere.

*3 Module with fixing frame. The base adapter ASQB3□N, ASQB□N, or ASQB5□N must be used or the AnS size Q series large type base unit must be used.

For details, refer to the "Upgrade Tool General Catalog" issued by Mitsubishi Electric Engineering Co., Ltd.

*4 For standard control by thermocouple input

*5 For standard control by platinum temperature measuring resistor input

*6 For heating/cooling control by thermocouple input

*7 For heating/cooling control by platinum temperature measuring resistor input

2) 2-slot type (inapplicable to AnS size Q series large type base unit)

Module type	MELSEC-AnS/QnAS Series module model	MELSEC-Q Series module model	Conversion adapter model
Input module	A1SX20	QX28 × 2 modules	ERNT-ASQTX20 ^{*1}
	A1SX20EU		
Output module	A1SY60	QY68A × 2 modules	ERNT-ASQTY60 ^{*1}
	A1SY60E		ERNT-ASQTY60E ^{*1}
Temperature control module with wire breakage detection	A1S64TCTTBW-S1	Q64TCTTBWN	ERNT-ASQT64TCTTBW ^{*2}
	A1S64TCTRTBW ^{*3}		
	A1S64TCRTBW-S1	Q64TCRTBWN	ERNT-ASQT64TCRTBW ^{*2}
	A1S64TCTRTBW ^{*4}		
	A1S62TCTTBW-S2	Q64TCTTBWN	ERNT-ASQT62TCTTBW ^{*2}
	A1S64TCTRTBW ^{*5}		
	A1S62TCRTBW-S2	Q64TCRTBWN	ERNT-ASQT62TCRTBW ^{*2}
A1S64TCTRTBW ^{*6}			

*1 The XY address will change because two replacement modules are used. The program must be revised.

Consider using FA goods if not changing the XY address.

*2 Model name of set of 1-slot type conversion adapter ERNT-ASQT64TC□□ and wire breakage detection connector conversion cable.

*3 For standard control by thermocouple input

*4 For standard control by platinum temperature measuring resistor input

*5 For heating/cooling control by thermocouple input

*6 For heating/cooling control by platinum temperature measuring resistor input

(b) Base adapter list

Module type	MELSEC-AnS/QnAS Series module model	MELSEC-Q Series module model	Conversion adapter model ^{*1}
Main base unit	A1S32B	Q33B	ERNT-ASQB32N
	A1S33B	Q33B	ERNT-ASQB33N
		Q33B + QA1S51B	ERNT-ASQB33N-S1 ^{*2}
	A1S35B	Q35B	ERNT-ASQB35N
		Q35B/Q33B + QA1S51B	ERNT-ASQB35N-S1 ^{*3}
A1S38B/A1S38HB	Q38B	ERNT-ASQB38N	
	Q38B/Q35B/Q33B + QA1S51B	ERNT-ASQB38N-S1 ^{*4}	
Extension base unit (with power supply)	A1S65B	Q65B	ERNT-ASQB65N
	A1S68B	Q68B	ERNT-ASQB68N
Extension base unit (without power supply)	A1S52B	Q52B	ERNT-ASQB52N
	A1S55B	Q55B	ERNT-ASQB55N
	A1S58B	Q68B ^{*5}	ERNT-ASQB58N
CPU/base unit integrated type	A1SJCPU	Q00JCPU	ERNT-ASQB00JN
	A1SJCPU-S3	Q00UJCPU	
	A1SJHCPU		

*1 The conversion adapter with fixing frame cannot be used with the base adapter that does not have "N" after the conventional model.

*2 The width is 36 mm larger, so mounting space must be secured. (No need to additionally drill mounting holes)

*3 The width is 22 mm larger, so mounting space must be secured. (No need to additionally drill mounting holes)

*4 Mountable within existing space (No need to additionally drill mounting holes)

*5 The Q68B must be replaced with the extension base unit (with power supply). When the base unit is selected, the power supply module must be selected.

(2) Utilizing the AnS size Q series large type base unit

Method: Mount on the alternative model by using the AnS size Q series large type base unit and by utilizing the terminal block of existing AnS series terminal block module through the upgrade tool manufactured by Mitsubishi Electric Engineering Co., Ltd.

Advantage: No need to process additional holes, and the existing wiring is usable.

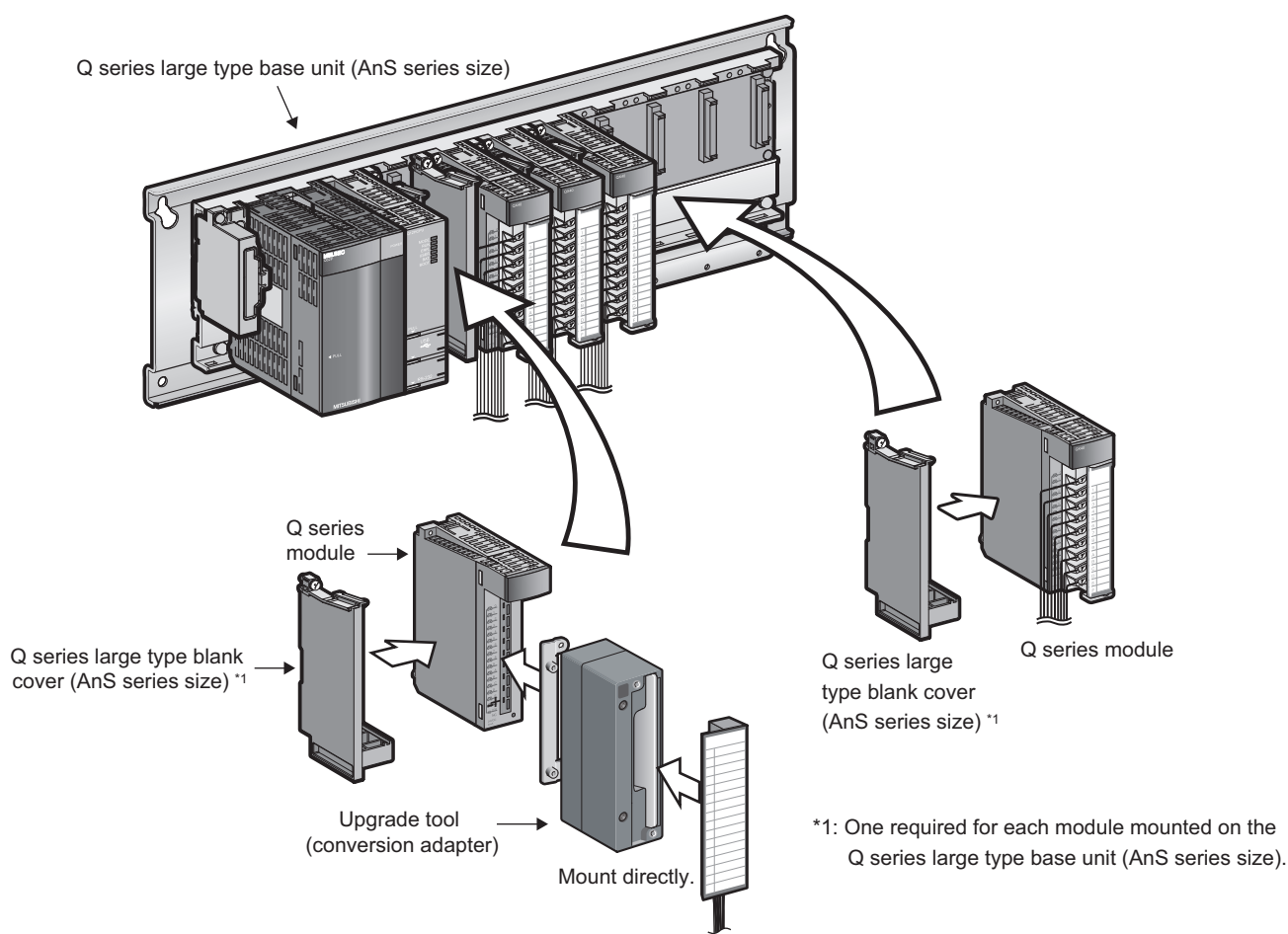

- (a) Wiring time is greatly reduced by utilizing the terminal block of existing AnS series terminal block module through the upgrade tool and by mounting on the alternative model, eliminating concerns about wire size.*2
- (b) The conversion adapter with fixing frame can be mounted without the optional tool.
- (c) The mounting of the connector type module without upgrade tool can be mixed.
- (d) New mounting holes do not need to be drilled since the mounting dimensions of the AnS size Q series large type base unit are the same as the AnS/QnAS series base unit.

*2 Module on which the 2-slot type conversion adapter and Q series large type blank cover cannot be attached cannot be mounted. For details, refer to Section 5.5.3.

(3) Replacing the CPU module with the QCPU, and replacing existing modules with the Q series modules in series with utilizing the existing A/AnS series module

Method: Replace the modules gradually by using the QA(1S) extension base unit (QA1S51B, QA(1S)6□B) and utilizing the property of AnS/QnAS series.

Advantage: The cost and workload for the transition can be divided, and yet the function extension can be continued during the transition.

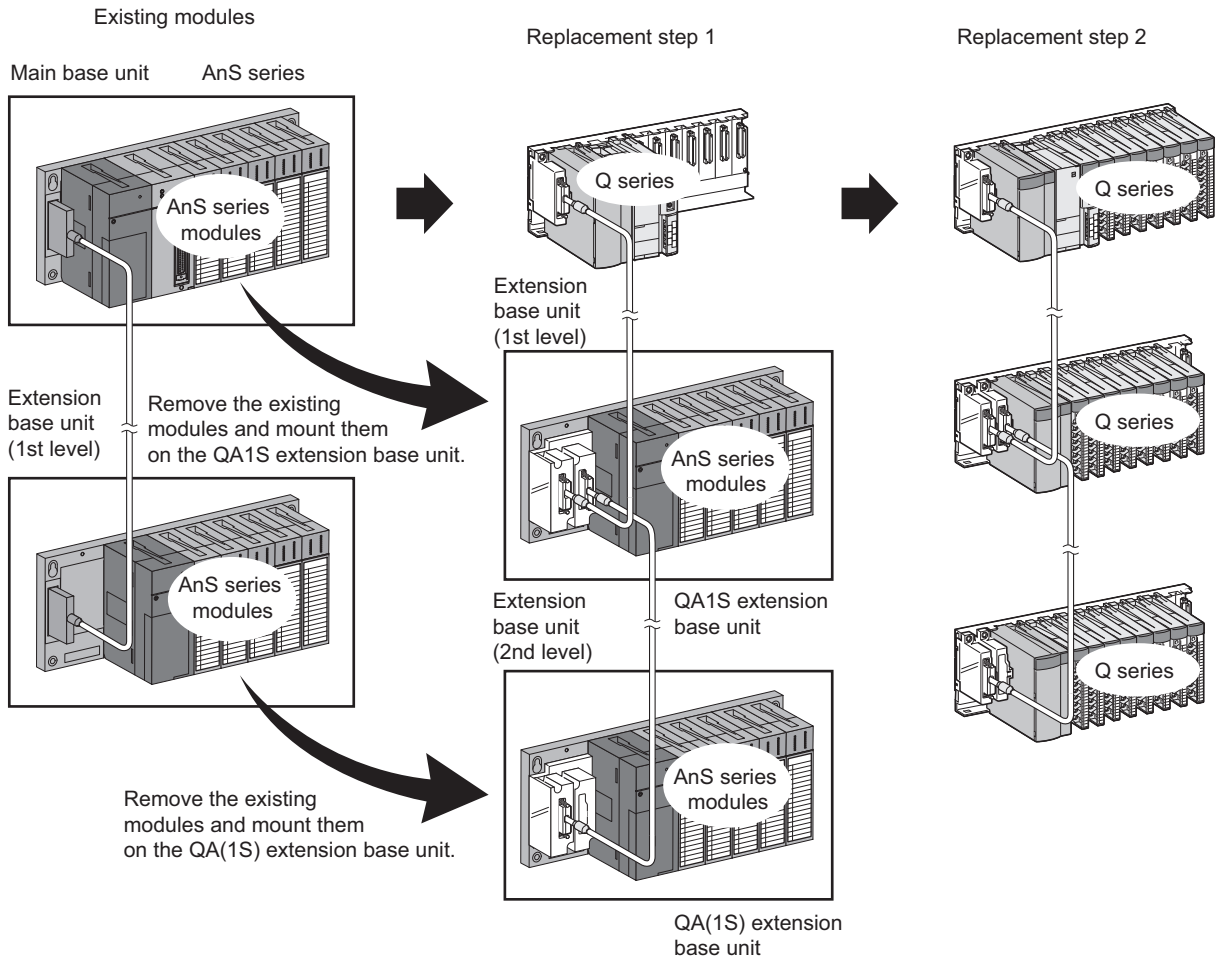

- (a) The QA(1S) extension base unit has the "QA6□B", supporting A series, and "QA1S51B" and "QA1S6□B", supporting AnS series.
When replacing the A/QnA series, the AnS series module can be utilized.
The QA1S51B is not extendable. Since the QA1S51B does not have an extension cable connector (OUT), it cannot be used with the QA6□B or QA6ADP+A5□B/A6□B.
- (b) When utilizing existing A/AnS series module, programs can be utilized without changing the existing I/O address with I/O assignment setting in PLC parameter.
For details of I/O address setting method with I/O assignment, refer to Section 5.4.6.

☒ Point

The QA(1S) extension base unit can be used with a High Performance model QCPU and Universal model QCPU (The serial number (first five digits) must be "13102" or later.).
For details and precautions of the QA(1S) extension base unit, refer to Section 5.4.

Replacement procedures:

Step 1

- Mount the QCPU and a module for function expansion on the Q series main base unit. Connect the QA1S extension base unit (QA1S6□B) to the main base unit as the first extension base unit and mount the power supply module and I/O module which are installed to the existing AnS main base unit series on it. (Wiring change is unnecessary.) If the first extension base unit is AnS series, replace it with QA1S extension base unit (QA1S6□B). If it is A series, replace it with QA extension base unit (QA6□B). Then mount a power supply module and I/O module on the extension base unit. (Wiring change is unnecessary.)
- Programs are automatically converted* by changing the programmable controller type from AnS/ QnAS CPU to QCPU using GX Developer.

* Some instructions are not automatically converted. In case of intelligent function module or network module, programs and parameters need be changed.

Step 2

After replacing the existing modules mounted on the QA(1S) extension base unit with the Q series modules, remove the QA extension base unit and QA(1S) series extension base unit.

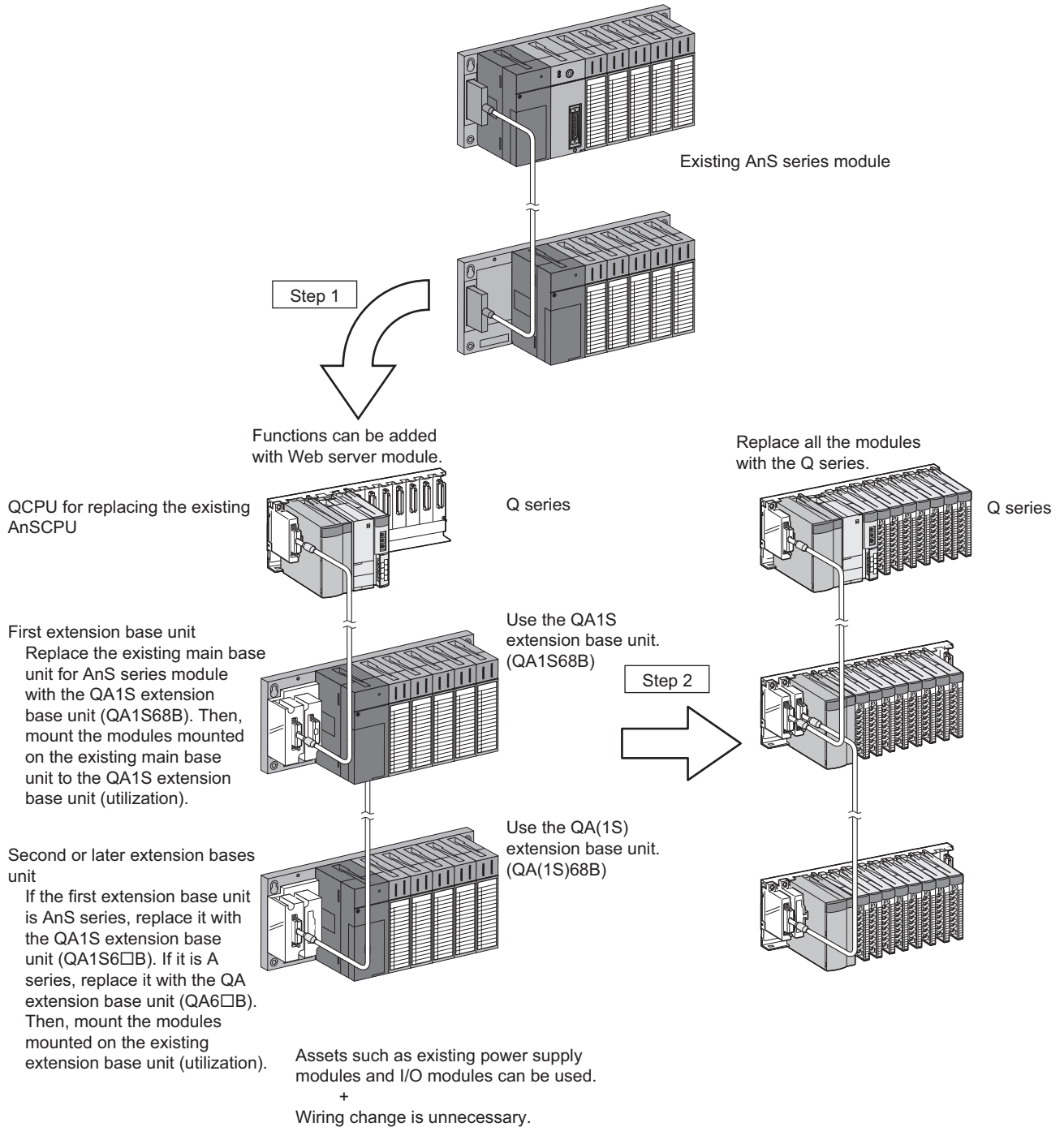

(4) Replacing only main base unit with the Q series, and replacing the extension base unit with the Q series modules in series with utilizing the existing A/AnS series module

Method: Replace the CPU module and all modules mounted on the main base unit with the Q series. Replace the extension base unit gradually by using the Q-AnS conversion adaptor (QA1S6ADP) and utilizing the property of AnS/QnAS series.

Advantage: The cost and workload for the transition can be divided, and yet the function extension can be continued during the transition.

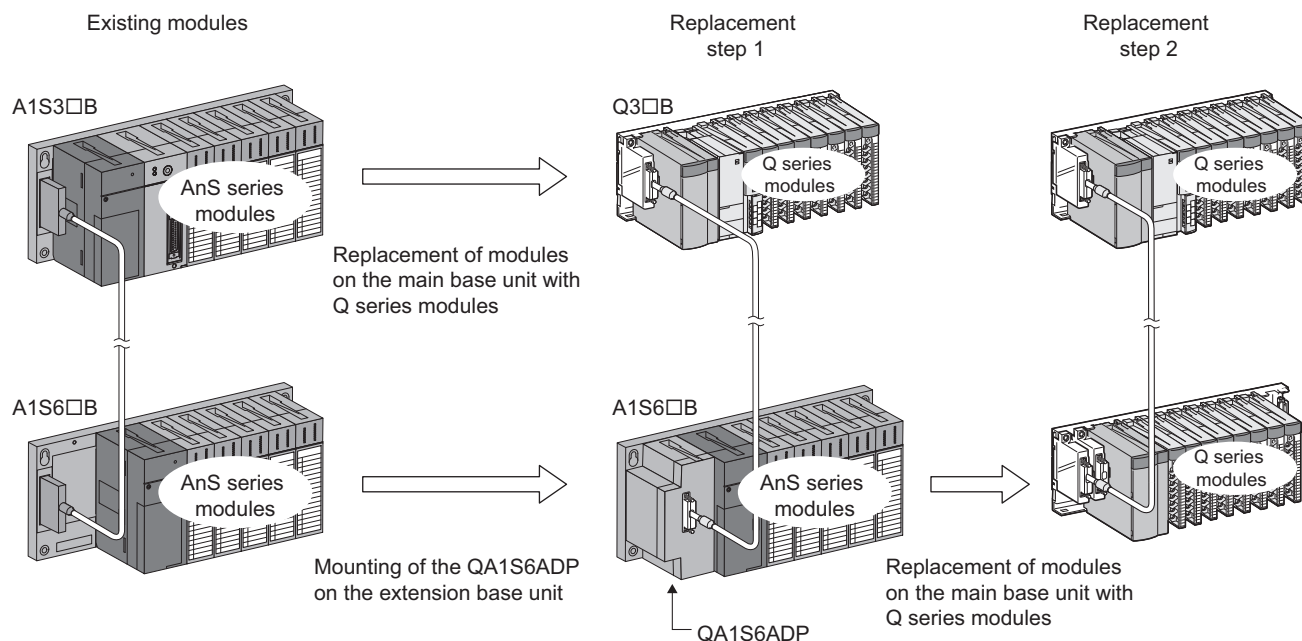

- (a) The extension base unit equipped with QA1S6ADP must be installed in the first extension stage. Since QA1S6ADP does not have an extension cable connector (OUT), it cannot be connected to the base unit in the second extension stage or higher. Therefore, when QA1S6ADP is used, the system consists of 2 base units, Q Series main base unit and AnS extension base unit equipped with QA1S6ADP.
- (b) When the existing A/AnS Series modules are used, the program can be used without changing the existing I/O addresses through I/O assignment by parameters. For the detailed procedures for setting the I/O addresses through I/O assignment, refer to Section 5.4.6 (2).

☒ Point

The AnS extension base unit equipped with QA1S6ADP can be used with a High Performance model QCPU and Universal model QCPU (The serial number (first five digits) must be "13102" or later.). For specifications and precautions of the QA1S6ADP, refer to the QA1S6ADP Q-AnS Base Unit Conversion Adapter User's Manual.

The modules which can be installed in the AnS extension base unit equipped with QA1S6ADP are the same as those installed in the QA1S extension base unit.

For details, refer to Section 5.4.5.

For MELSEC-A/QnA(large type) Series to Q Series transition related products manufactured by Mitsubishi Electric Engineering Co., Ltd. or Mitsubishi Electric System & Service Co., Ltd., contact your local sales office or representative.

1.2.3 Precautions for transition

- (1) Before replacing the A/AnS/QnA/QnAS series by the Q series, be sure to refer to manuals for each Q series module to check the functions, specifications, and usage.
- (2) For products manufactured by Mitsubishi Electric Engineering Co., Ltd. and Mitsubishi Electric System & Service Co., Ltd., refer to the catalog for each product shown in Appendix to develop an understanding of the detailed specifications, precautions and restrictions for use for correct usage.
- (3) After replacing the A/AnS/QnA/QnAS series by the Q series, be sure to check operations of the whole system before the actual operation.

2 REPLACEMENT OF CPU MODULE

The following is an example of alternative Q series CPU modules that can be chosen based on compatibility with previous AnS series CPU. The optimal AnS series replacement may be selected based on type of control, specifications, system scalability and cost.

2.1 List of Alternative Models of CPU Module

(1) Replacement with Universal model QCPU

AnS/QnAS series model		Q series alternative model	
Product	Model	Model	Remarks (restrictions)
CPU module	A1SJHCPU/ A1SJCPU/ A1SJCPU-S3	Q00UJCPU	1) I/O control: Refresh/direct switch → Refresh only 2) Processing speed (LD instruction) : During refresh 0.33μs (A1SJHCPU) → 0.12μs 1.0μs (A1SJCPU/A1SJCPU-S3) → 0.12μs 3) PC MIX value: 0.4 → 4.92 4) Number of I/O points: 256 points 5) Number of I/O device points: 2048 points → 8192 points 6) Program capacity: 8k steps → 10k steps 7) Number of file register points: 8k points → 0 points 8) Number of extension stages: 2 stages → 2 stages (GOT bus connection can be made up to 2 stages.) 9) Applicable memory: Built-in RAM/E ² PROM cassette (sold separately) → program memory/Standard ROM 10) Microcomputer program: available → not available 11) configuration: including 5 slot base unit, CPU module and power supply module
		Q00UCPU	1) I/O control: Refresh/direct switch → Refresh only 2) Processing speed (LD instruction) : During refresh 0.33μs (A1SJHCPU) → 0.08μs 1.0μs (A1SJCPU/A1SJCPU-S3) → 0.12μs 3) PC MIX value: 0.4 → 7.36 4) Number of I/O points: 256 points → 1024 points 5) Number of I/O device points: 2048 points → 8192 points 6) Program capacity: 8k steps → 10k steps 7) Number of file register points: 8k points → 64k points 8) Number of extension stages: 1 stage → 4 stages (GOT bus connection can be made up to 4 stages.) 9) Applicable memory: Built-in RAM/E ² PROM cassette (sold separately) → program memory/Standard RAM/Standard ROM 10) Microcomputer program: available → not available
	A1SHCPU	Q00UCPU	1) I/O control: Refresh/direct switch → Refresh only 2) Processing speed (LD instruction) : During refresh 0.33μs → 0.08μs 3) PC MIX value: 0.4 → 7.36 4) Number of I/O points: 256 points → 1024 points 5) Number of I/O device points: 2048 points → 8192 points 6) Program capacity: 8k steps → 10k steps 7) Number of file register points: 8k points → 64k points 8) Number of extension stages: 1 stage → 4 stages (GOT bus connection can be made up to 4 stages.) 9) Applicable memory: Built-in RAM/E ² PROM cassette (sold separately) → program memory/Standard RAM/Standard ROM 10) Microcomputer program: available → not available

AnS/QnAS series model		Q series alternative model	
Product	Model	Model	Remarks (restrictions)
CPU module	A1SCPU/ A1SCPUC24- R2*1	Q00UCPU	1) I/O control: Refresh/direct switch → Refresh only 2) Processing speed (LD instruction) : During refresh 1.0μs → 0.08μs 3) PC MIX value: 0.4 → 7.36 4) Number of I/O points: 256 points → 1024 points 5) Number of I/O device points: 2048 points → 8192 points 6) Program capacity: 8k steps → 10k steps 7) Number of file register points: 4k points → 64k points 8) Number of extension stages: 1 stage → 4 stages (GOT bus connection can be made up to 4 stages.) 9) Applicable memory: Built-in RAM/E ² PROM cassette (sold separately) → program memory/Standard RAM/Standard ROM 10) Microcomputer program: available → not available
	A2SHCPU	Q01UCPU	1) I/O control: Refresh/direct switch → Refresh only 2) Processing speed (LD instruction) : During refresh 0.25μs → 0.06μs 3) PC MIX value: 0.5 → 9.79 4) Number of I/O points: 512 points → 1024 points 5) Number of I/O device points: 2048 points → 8192 points 6) Program capacity: 14k steps → 15k steps 7) Number of file register points: 8k points → 64k points 8) Number of extension stages: 1 stage → 4 stages (GOT bus connection can be made up to 4 stages.) 9) Applicable memory: Built-in RAM/E ² PROM cassette (sold separately) → program memory/Standard RAM/Standard ROM 10) Microcomputer program: available → not available
	A2SCPU	Q01UCPU	1) I/O control: Refresh/direct switch → Refresh only 2) Processing speed (LD instruction) : During refresh 1.0μs → 0.06μs 3) PC MIX value: 0.5 → 9.79 4) Number of I/O points: 512 points → 1024 points 5) Number of I/O device points: 2048 points → 8192 points 6) Program capacity: 14k steps → 15k steps 7) Number of file register points: 4k points → 64k points 8) Number of extension stages: 1 stage → 4 stages (GOT bus connection can be made up to 4 stages.) 9) Applicable memory: Built-in RAM/E ² PROM cassette (sold separately) → program memory/Standard RAM/Standard ROM 10) Microcomputer program: available → not available
	A2USCPU	Q02UCPU	1) I/O control: Refresh only 2) Processing speed (LD instruction) : 0.2μs → 0.04μs 3) PC MIX value: 0.9 → 14 4) Number of I/O points: 512 points → 2048 points 5) Number of I/O device points: 8192 points → 8192 points 6) Program capacity: 14k steps → 20k steps 7) Number of file register points: 8k points → 64k points (Using memory card: Max.4086k points) 8) Number of extension stages: 1 stage → 4 stages (GOT bus connection can be made up to 4 stages.) 9) Applicable memory: Built-in RAM/E ² PROM cassette (sold separately) → program memory/Standard RAM/Standard ROM/memory card (sold separately) 10) Microcomputer program: not available 11) Sequence instruction: AnA/AnU-dedicated instructions are replaceable.*2

AnS/QnAS series model		Q series alternative model	
Product	Model	Model	Remarks (restrictions)
CPU module	A2USHCPU-S1	Q02UCPU	<ol style="list-style-type: none"> 1) I/O control: Refresh only 2) Processing speed (LD instruction) : 0.09μs → 0.04μs 3) PC MIX value: 2.0 → 14 4) Number of I/O points: 1024 points → 2048 points 5) Number of I/O device points: 8192 points → 8192 points 6) Program capacity: 30k steps → 20k steps 7) Number of file register points: 8k points → 64k points (Using memory card: Max.4086k points) 8) Number of extension stages: 1 stage → 4 stages (GOT bus connection can be made up to 4 stages.) 9) Applicable memory: Built-in RAM/E²PROM cassette (sold separately) → program memory/Standard RAM/Standard ROM/memory card (sold separately) 10) Microcomputer program: not available 11) Sequence instruction: AnA/AnU-dedicated instructions are replaceable.*²
		Q03UD(E)CPU/ Q03UDVCPU	<ol style="list-style-type: none"> 1) I/O control: Refresh only 2) Processing speed (LD instruction) : 0.09μs → 0.02μs (Q03UD(E)CPU) 0.09μs → 0.0019μs (Q03UDVCPU) 3) PC MIX value: 2.0 → 28 (Q03UD(E)CPU)/227 (Q03UDVCPU) 4) Number of I/O points: 1024 points → 4096 points 5) Number of I/O device points: 8192 points → 8192 points 6) Program capacity: 30k steps → 30k steps 7) Number of file register points: 8k points → 96k points (Using memory card (Q03UD(E)CPU): Max.4086k points) (Using extended SRAM cassette (Q03UDVCPU): Max.4192k points) 8) Number of extension stages: 1 stage → 7 stages 9) Applicable memory: Built-in RAM/E²PROM cassette (sold separately) → program memory/Standard RAM/Standard ROM/memory card^{*3} (sold separately) 10) Microcomputer program: not available 11) Sequence instruction: AnA/AnU-dedicated instructions are replaceable.*²
	Q2ASCPU	Q02UCPU	<ol style="list-style-type: none"> 1) I/O control: Refresh only 2) Processing speed (LD instruction) : 0.2μs → 0.04μs 3) PC MIX value: 1.3 → 14 4) Number of I/O points: 512 points → 2048 points 5) Number of I/O device points: 8192 points → 8192 points 6) Program capacity: 28k steps → 20k steps 7) Number of file register points: 0k points (Memory card (sold separately) is necessary.) → 64k points (Using memory card: Max.4086k points) 8) Number of extension stages: 1 stage → 4 stages (GOT bus connection can be made up to 4 stages.) 9) Applicable memory: Built-in RAM/memory card (sold separately) → program memory/Standard RAM/Standard ROM/memory card (sold separately) 10) Microcomputer program: not available
		Q03UD(E)CPU/ Q03UDVCPU	<ol style="list-style-type: none"> 1) I/O control: Refresh only 2) Processing speed (LD instruction) : 0.2μs → 0.02μs (Q03UD(E)CPU) 0.2μs → 0.0019μs (Q03UDVCPU) 3) PC MIX value: 1.3 → 28 (Q03UD(E)CPU)/227 (Q03UDVCPU) 4) Number of I/O points: 512 points → 4096 points 5) Number of I/O device points: 8192 points → 8192 points 6) Program capacity: 14k steps → 30k steps 7) Number of file register points: 0k points (Memory card (sold separately) is necessary.) → 96k points (Using memory card (Q03UD(E)CPU): Max.4086k points) (Using extended SRAM cassette (Q03UDVCPU): Max.4192k points) 8) Number of extension stages: 1 stage → 7 stages 9) Applicable memory: program memory/memory card (sold separately) → program memory/Standard RAM/Standard ROM/memory card^{*3} (sold separately) 10) Microcomputer program: not available

AnS/QnAS series model		Q series alternative model	
Product	Model	Model	Remarks (restrictions)
CPU module	Q2ASCPU-S1	Q04UD(E)HCPU /Q04UDVCPU	1) I/O control: Refresh only 2) Processing speed (LD instruction) : 0.2 μ s → 0.0095 μ s (Q04UD(E)HCPU) 0.2 μ s → 0.0019 μ s (Q04UDVCPU) 3) PC MIX value: 1.3 → 60 (Q04UD(E)HCPU)/227 (Q04UDVCPU) 4) Number of I/O points: 1024 points → 4096 points 5) Number of I/O device points: 8192 points → 8192 points 6) Program capacity: 60k steps → 40k steps 7) Number of file register points: 0k points (Memory card (sold separately) is necessary.) → 128k points (Using memory card (Q04UD(E)HCPU): Max.4086k points) (Using extended SRAM cassette (Q04UDVCPU): Max.4224k points) 8) Number of extension stages: 1 stage → 7 stages 9) Applicable memory: program memory/memory card (sold separately) → program memory/Standard RAM/Standard ROM/memory card ^{*3} (sold separately) 10) Microcomputer program: not available
		Q06UD(E)HCPU /Q06UDVCPU	1) I/O control: Refresh only 2) Processing speed (LD instruction) : 0.2 μ s → 0.0095 μ s (Q06UD(E)HCPU) 0.2 μ s → 0.0019 μ s (Q06UDVCPU) 3) PC MIX value: 1.3 → 60 (Q06UD(E)HCPU)/227 (Q06UDVCPU) 4) Number of I/O points: 1024 points → 4096 points 5) Number of I/O device points: 8192 points → 8192 points 6) Program capacity: 60k steps → 60k steps 7) Number of file register points: 0k points (Memory card (sold separately) is necessary.) → 384k points (Using memory card (Q06UD(E)HCPU): Max.4086k points) (Using extended SRAM cassette (Q06UDVCPU): Max.4480k points) 8) Number of extension stages: 1 stage → 7 stages 9) Applicable memory: program memory/memory card (sold separately) → program memory/Standard RAM/Standard ROM/memory card ^{*3} (sold separately) 10) Microcomputer program: not available
	Q2ASHCPU	Q02UCPU	1) I/O control: Refresh only 2) Processing speed (LD instruction) : 0.075 μ s → 0.04 μ s 3) PC MIX value: 3.8 → 14 4) Number of I/O points: 512 points → 2048 points 5) Number of I/O device points: 8192 points → 8192 points 6) Program capacity: 28k steps → 20k steps 7) Number of file register points: 0k points (Memory card (sold separately) is necessary.) → 64k points (Using memory card: Max.4086k points) 8) Number of extension stages: 1 stage → 4 stages (GOT bus connection can be made up to 4 stages.) 9) Applicable memory: program memory/memory card (sold separately) → program memory/Standard RAM/Standard ROM/memory card (sold separately) 10) Microcomputer program: not available
		Q03UD(E)CPU/ Q03UDVCPU	1) I/O control: Refresh only 2) Processing speed (LD instruction) : 0.075 μ s → 0.02 μ s (Q03UD(E)CPU) 0.075 μ s → 0.0019 μ s (Q03UDVCPU) 3) PC MIX value: 3.8 → 28 (Q03UD(E)CPU)/227 (Q03UDVCPU) 4) Number of I/O points: 512 points → 4096 points 5) Number of I/O device points: 8192 points → 8192 points 6) Program capacity: 28k steps → 30k steps 7) Number of file register points: 0k points (Memory card (sold separately) is necessary.) → 96k points (Using memory card (Q03UD(E)CPU): Max.4086k points) (Using extended SRAM cassette (Q03UDVCPU): Max.4192k points) 8) Number of extension stages: 1 stage → 7 stages 9) Applicable memory: program memory/memory card (sold separately) → program memory/Standard RAM/Standard ROM/memory card ^{*3} (sold separately) 10) Microcomputer program: not available

AnS/QnAS series model		Q series alternative model	
Product	Model	Model	Remarks (restrictions)
CPU module	Q2ASHCPU-S1	Q04UD(E)HCPU /Q04UDVCPU	1) I/O control: Refresh only 2) Processing speed (LD instruction) : 0.075 μ s \rightarrow 0.0095 μ s (Q04UD(E)HCPU) 0.075 μ s \rightarrow 0.0019 μ s (Q04UDVCPU) 3) PC MIX value: 3.8 \rightarrow 60 (Q04UD(E)HCPU)/227 (Q04UDVCPU) 4) Number of I/O points: 1024 points \rightarrow 4096 points 5) Number of I/O device points: 8192 points \rightarrow 8192 points 6) Program capacity: 60k steps \rightarrow 40k steps 7) Number of file register points: 0k points (Memory card (sold separately) is necessary.) \rightarrow 128k points (Using memory card (Q04UD(E)HCPU): Max.4086k points) (Using extended SRAM cassette (Q04UDVCPU): Max.4224k points) 8) Number of extension stages: 1 stage \rightarrow 7 stages 9) Applicable memory: program memory/memory card (sold separately) \rightarrow program memory/Standard RAM/Standard ROM/memory card* ³ (sold separately) 10) Microcomputer program: not available
		Q06UD(E)HCPU /Q06UDVCPU	1) I/O control: Refresh only 2) Processing speed (LD instruction) : 0.075 μ s \rightarrow 0.0095 μ s (Q06UD(E)HCPU) 0.075 μ s \rightarrow 0.0019 μ s (Q06UDVCPU) 3) PC MIX value: 3.8 \rightarrow 60 (Q06UD(E)HCPU)/227 (Q06UDVCPU) 4) Number of I/O points: 1024 points \rightarrow 4096 points 5) Number of I/O device points: 8192 points \rightarrow 8192 points 6) Program capacity: 60k steps 7) Number of file register points: 0k points (Memory card (sold separately) is necessary.) \rightarrow 384k points (Using memory card (Q06UD(E)HCPU): Max.4086k points) (Using extended SRAM cassette (Q06UDVCPU): Max.4480k points) 8) Number of extension stages: 1 stage \rightarrow 7 stages 9) Applicable memory: program memory/memory card (sold separately) \rightarrow program memory/Standard RAM/Standard ROM/memory card* ³ (sold separately) 10) Microcomputer program: not available

- *1 The CPU module with the communications function can be replaced with the CPU module and the communication module as listed in the following table.

Model	Alternative models		Precaution
	CPU module model	Communication module model	
A1SCPUC24-R2	Q00UCPU	QJ71C24N/ QJ71C24N-R2	Mounting the A/QnA series CPU module with the communications function on a base unit → Mounting a communication module on a base unit (1 slot is required and 32 points are occupied.)

- *2 The instruction for file registers and special function modules need to be replaced with those for the Q series.
*3 The High-speed Universal model QCPU (QnUDVCPU) supports an SD memory card.

(2) Replacement with High Performance model QCPU

AnS/QnAS series model		Q series alternative model	
Product	Model	Model	Remarks (restrictions)
CPU module	A1SJHCPU/ A1SJCPU/ A1SJCPU-S3	Q00JCPU	1) I/O control: refresh mode and direct mode switching → refresh only 2) Processing speed (LD instruction): During refresh 0.33μs (A1SJHCPU) → 0.2μs 1.0μs (A1SJCPU/A1SJCPU-S3) → 0.2μs 3) PC MIX value: 0.4 → 1.6 4) Number of I/O points: 256 points → 256 points 5) Number of I/O device points: 2048 points → 2048 points 6) Program size: 8K steps → 8K steps 7) Number of file register points: 8K points → 0 points 8) Number of extension bases: 1 stage → 2 stages 9) Used memory: built-in RAM/EEP-ROM cassette (sold separately) → program memory/standard ROM 10) Microcomputer program: available → not available 11) Structure: 5-slot base unit, CPU module, and power supply module are integrated.
		Q00CPU	1) I/O control: refresh mode and direct mode switching → refresh only 2) Processing speed (LD instruction): During refresh 0.33μs (A1SJHCPU) → 0.16μs 1.0μs (A1SJCPU/A1SJCPU-S3) → 0.16μs 3) PC MIX value: 0.4 → 2.0 4) Number of I/O points: 256 points → 1024 points 5) Number of I/O device points: 2048 points → 2048 points 6) Program size: 8K steps → 8K steps 7) Number of file register points: 8K points → 64K points 8) Number of extension bases: 1 stage → 4 stages 9) Used memory: built-in RAM/EEP-ROM cassette (sold separately) → program memory/standard RAM/standard ROM 10) Microcomputer program: available → not available 11) Structure: 5-slot base unit, CPU module, and power supply module are integrated. → Main base unit, CPU module, and power supply module are separated.
	A1SHCPU	Q00CPU	1) I/O control: refresh mode and direct mode switching → refresh only 2) Processing speed (LD instruction): During refresh 0.33μs → 0.16μs 3) PC MIX value: 0.4 → 2.0 4) Number of I/O points: 256 points → 1024 points 5) Number of I/O device points: 2048 points → 2048 points 6) Program size: 8K steps → 8K steps 7) Number of file register points: 8K points → 64K points 8) Number of extension bases: 1 stage → 4 stages 9) Used memory: built-in RAM/EEP-ROM cassette (sold separately) → program memory/standard RAM//standard ROM 10) Microcomputer program: available → not available
	A1SCPU/ A1SCPUC24- R2 ^{*1}	Q00CPU	1) I/O control: refresh mode and direct mode switching → refresh only 2) Processing speed (LD instruction): During refresh 1.0μs → 0.16μs 3) PC MIX value: 0.4 → 2.0 4) Number of I/O points: 256 points → 1024 points 5) Number of I/O device points: 2048 points → 2048 points 6) Program size: 8K steps → 8K steps 7) Number of file register points: 4K points → 64K points 8) Number of extension bases: 1 stage → 4 stages 9) Used memory: built-in RAM/EEP-ROM cassette (sold separately) → program memory/standard RAM//standard ROM 10) Microcomputer program: available → not available
	A2SHCPU	Q01CPU	1) I/O control: refresh mode and direct mode switching → refresh only 2) Processing speed (LD instruction): During refresh 0.25μs → 0.1μs 3) PC MIX value: 0.5 → 2.7 4) Number of I/O points: 512 points → 1024 points 5) Number of I/O device points: 2048 points → 2048 points 6) Program size: 14K steps → 14K steps 7) Number of file register points: 8K points → 64K points 8) Number of extension bases: 1 stage → 4 stages 9) Used memory: built-in RAM/EEP-ROM cassette (sold separately) → program memory/standard RAM//standard ROM 10) Microcomputer program: available → not available

AnS/QnAS series model		Q series alternative model	
Product	Model	Model	Remarks (restrictions)
CPU module	A2SCPU	Q01CPU	1) I/O control: refresh mode and direct mode switching → refresh only 2) Processing speed (LD instruction): During refresh 1.0μs → 0.1μs 3) PC MIX value: 0.5 → 2.7 4) Number of I/O points: 512 points → 1024 points 5) Number of I/O device points: 2048 points → 2048 points 6) Program size: 14K steps → 14K steps 7) Number of file register points: 4K points → 64K points 8) Number of extension bases: 1 stage → 4 stages 9) Used memory: built-in RAM/EEP-ROM cassette (sold separately) → program memory/standard RAM/standard ROM 10) Microcomputer program: available → not available
	A2USCPU	Q02CPU	1) I/O control: refresh only 2) Processing speed (LD instruction): 0.2μs → 0.079μs 3) PC MIX value: 0.9 → 4.4 4) Number of I/O points: 512 points → 4096 points 5) Number of I/O device points: 8192 points → 8192 points 6) Program size: 14K steps → 28K steps 7) Number of file register points: 8K points → 32K points (Using memory card: Max.1018k points) 8) Number of extension bases: 1 stage → 7 stages 9) Used memory: built-in RAM/EEP-ROM cassette (sold separately) → program memory/standard RAM/standard ROM/memory card (sold separately) 10) Microcomputer program: not available 11) Sequence instruction: AnA/AnU-dedicated instructions are replaceable.*2
	A2USHCPU-S1	Q02HCPU	1) I/O control: refresh only 2) Processing speed (LD instruction): 0.09μs → 0.034μs 3) PC MIX value: 2.0 → 10.3 4) Number of I/O points: 1024 points → 4096 points 5) Number of I/O device points: 8192 points → 8192 points 6) Program size: 30K steps → 28K steps 7) Number of file register points: 8K points → 64K points (Using memory card: Max.1018k points) 8) Number of extension bases: 1 stage → 7 stages 9) Used memory: built-in RAM/EEP-ROM cassette (sold separately) → program memory/standard RAM/standard ROM/memory card (sold separately) 10) Microcomputer program: not available 11) Sequence instruction: AnA/AnU-dedicated instructions are replaceable.*2
		Q06HCPU	1) I/O control: refresh only 2) Processing speed (LD instruction): 0.09μs → 0.034μs 3) PC MIX value: 2.0 → 10.3 4) Number of I/O points: 1024 points → 4096 points 5) Number of I/O device points: 8192 points → 8192 points 6) Program size: 30K steps → 60K steps 7) Number of file register points: 8K points → 64K points (Using memory card: Max.1018k points) 8) Number of extension bases: 1 stage → 7 stages 9) Used memory: built-in RAM/EEP-ROM cassette (sold separately) → program memory/standard RAM/standard ROM/memory card (sold separately) 10) Microcomputer program: not available 11) Sequence instruction: AnA/AnU-dedicated instructions are replaceable.*2
	Q2ASCPU	Q02HCPU	1) I/O control: refresh only 2) Processing speed (LD instruction): 0.2μs → 0.034μs 3) PC MIX value: 1.3 → 10.3 4) Number of I/O points: 512 points → 4096 points 5) Number of I/O device points: 8192 points → 8192 points 6) Program size: 28K steps → 28K steps 7) Number of file register points: 0K points (A memory card (sold separately) is required for use.) → 64K points (Using memory card: Max.1018k points) 8) Number of extension bases: 1 stage → 7 stages 9) Used memory: built-in RAM/memory card (sold separately) → program memory/standard RAM/standard ROM/memory card (sold separately) 10) Microcomputer program: not available

AnS/QnAS series model		Q series alternative model	
Product	Model	Model	Remarks (restrictions)
CPU module	Q2ASCPU-S1	Q06HCPU	1) I/O control: refresh only 2) Processing speed (LD instruction): 0.2μs → 0.034μs 3) PC MIX value: 1.3 → 10.3 4) Number of I/O points: 1024 points → 4096 points 5) Number of I/O device points: 8192 points → 8192 points 6) Program size: 60K steps → 60K steps 7) Number of file register points: 0K points (A memory card (sold separately) is required for use.) → 64K points (Using memory card: Max.1018k points) 8) Number of extension bases: 1 stage → 7 stages 9) Used memory: built-in RAM/memory card (sold separately) → program memory/standard RAM/standard ROM/memory card (sold separately) 10) Microcomputer program: not available
	Q2ASHCPU	Q02HCPU	1) I/O control: refresh only 2) Processing speed (LD instruction): 0.075μs → 0.034μs 3) PC MIX value: 3.8 → 10.3 4) Number of I/O points: 512 points → 4096 points 5) Number of I/O device points: 8192 points → 8192 points 6) Program size: 28K steps → 28K steps 7) Number of file register points: 0K points (A memory card (sold separately) is required for use.) → 64K points (Using memory card: Max.1018k points) 8) Number of extension bases: 1 stage → 7 stages 9) Used memory: built-in RAM/memory card (sold separately) → program memory/standard RAM/standard ROM/memory card (sold separately) 10) Microcomputer program: not available
	Q2ASHCPU-S1	Q06HCPU	1) I/O control: refresh only 2) Processing speed (LD instruction): 0.075μs → 0.034μs 3) PC MIX value: 3.8 → 10.3 4) Number of I/O points: 1024 points → 4096 points 5) Number of I/O device points: 8192 points → 8192 points 6) Program size: 60K steps → 60K steps 7) Number of file register points: 0K points (A memory card (sold separately) is required for use.) → 64K points (Using memory card: Max.1018k points) 8) Number of extension bases: 1 stage → 7 stages 9) Used memory: built-in RAM/memory card (sold separately) → program memory/standard RAM/standard ROM/memory card (sold separately) 10) Microcomputer program: not available

*1 The CPU module with the communications function can be replaced with the CPU module and the communication module as listed in the following table.

Model	Alternative models		Precaution
	CPU module model	Communication module model	
A1SCPUC24-R2	Q00UCPU	QJ71C24N	Mounting the A/QnA series CPU module with the communications function on a base unit → Mounting a communication module on a base unit (1 slot is required and 32 points are occupied.)

*2 The instruction for file registers and special function modules need to be replaced with those for the Q series.

☒ Point

The specification comparison between AnS/QnASCPU and Basic model QCPU is in the Appendices.

2.2 Comparison of CPU Module Specifications

(1) Comparison between AnS/QnASCPU and Universal model QCPU

○: Available △: Although available, specifications such as setting method partially differ. ×: Not available

Function	Description	AnS series				QnAS series		
		A1SJHCPU A1SHCPU	A2SHCPU	A2USCPU	A2USHCPU -S1	Q2ASCPU Q2ASCPU-S1	Q2ASHCPU Q2ASHCPU-S1	
Control method	Repetitive operation of stored program	○	○	○	○	○	○	
I/O control method	Refresh mode/direct mode	○ *1	○ *1	○ *2	○ *2	○ *2	○ *2	
Programming language	Language dedicated to sequence control (relay symbol, logic symbol, MELCAP language)	○	○	○	○	○	○	
Processing speed	Sequence instructions (μs/steps)	0.33	0.25	0.2	0.09	0.2	0.075	
Watchdog timer (WDT)	Watchdog timer (WDT) (ms)	10 to 2000	10 to 2000	200	200	10 to 2000	10 to 2000	
Memory capacity	User memory built-in capacity (byte)	64K (RAM) *3	64K (RAM) *3	64K (RAM) *3	256K (RAM) *3	Program memory (RAM) *7	Program memory (RAM) *7	
	Sold separately	Memory cassette*4 (EEP-ROM)	Memory cassette*4 (EEP-ROM)	Memory cassette*4 (EEP-ROM)	Memory cassette*4 (EEP-ROM)	Memory card (Max. 2M)	Memory card (Max. 2M)	
Program capacity	Sequence program (steps)	Max. 8K	Max. 14K	Max. 14K	Max. 30K	Max. 28K (-S1: 60K)	Max. 28K (-S1: 60K)	
	Microcomputer program (byte)	Max. 14K*8	Max. 26K*8	×	×	×	×	
Number of I/O points	Number of I/O points (point)*6	256	512	512	1024	512 (-S1:1024)	512 (-S1:1024)	

- *1 I/O control mode (refresh mode or direct mode) is selectable with the I/O control method setting switch.
- *2 Only refresh mode is available, but there are instructions and devices that can use direct mode.
- *3 Free space areas (except that in the program memory) can be used as user memory.
- *4 Memory cassette is for copying programs to the ROM. Use of the cassette does not increase the memory capacity.
- *5 Only one memory card can be used.
- *6 This number means the number of applicable points for the access to actual I/O modules.
- *7 The memory capacity corresponds to the maximum number of steps in a sequence program.
- *8 The program capacity is included to a sequence program.
- *9 The processing speed of the High-speed Universal model QCPU (QnUDVCPU) is 0.0019μs/step.
- *10 The standard ROM capacity of the Q03UDVCPU, Q04UDVCPU, and Q06UDVCPU is 1025.5K bytes.
- *11 The High-speed Universal model QCPU (QnUDVCPU) supports an SD memory card.

○: Available △: Although available, specifications such as setting method partially differ. ×: Not available

Universal model QCPU								Precautions for replacement	Reference
Q00UJCPU	Q00UCPU	Q01UCPU	Q02UCPU	Q03UD(E)CPU/ Q03UDVCPU	Q04UD(E)HCPU/ Q04UDVCPU	Q06UD(E)HCPU/ Q06UDVCPU			
○	○	○	○	○	○	○	○	-	
○ *2	○ *2	○ *2	○ *2	○ *2	○ *2	○ *2	○ *2	For the Q series, only refresh mode is available. To input or output data in direct mode, use the direct input/output dedicated instructions.	
○	○	○	○	○	○	○	○	The MELSAP language for the A/AnS series is MELSAP-II and that for the QnA/Q2AS/Q series is MELSAP3.	
0.12	0.08	0.06	0.04	0.02 ^{*9}	0.0095 ^{*9}	0.0095 ^{*9}	0.0095 ^{*9}	-	
10 to 2000	10 to 2000	10 to 2000	10 to 2000	10 to 2000	10 to 2000	10 to 2000	10 to 2000	-	
(Set in units of 10ms)								-	
• Program memory ^{*7} : 40K • Standard RAM: - • Standard ROM: 256K	• Program memory ^{*7} : 40K • Standard RAM: 128K • Standard ROM: 512K	• Program memory ^{*7} : 60K • Standard RAM: 128K • Standard ROM: 512K	• Program memory ^{*7} : 80K • Standard RAM: 128K • Standard ROM: 512K	• Program memory ^{*7} : 120K • Standard RAM: 192K • Standard ROM ^{*10} : 1024K	• Program memory ^{*7} : 160K • Standard RAM: 256K • Standard ROM ^{*10} : 1024K	• Program memory ^{*7} : 240K • Standard RAM: 768K • Standard ROM ^{*10} : 1024K		-	
×	×	×	Memory card ^{*5} RAM: Max. 8M Flash: Max. 4M ATA: Max. 32M	Memory card ^{*5} RAM: Max. 8M Flash: Max. 4M ATA: Max. 32M SD ^{*11} : 2GB/4GB	Memory card ^{*5} RAM: Max. 8M Flash: Max. 4M ATA: Max. 32M SD ^{*11} : 2GB/4GB	Memory card ^{*5} RAM: Max. 8M Flash: Max. 4M ATA: Max. 32M SD ^{*11} : 2GB/4GB		-	
Max. 10K	Max. 10K	Max. 15K	Max. 20K	Max. 30K	Max. 40K	Max. 60K	Max. 60K	-	
×	×	×	×	×	×	×	×	For the Q series, microcomputer programs cannot be used. Consider replacing those microcomputer programs with sequence programs.	
256	1024	1024	2048	4096	4096	4096	4096	-	

○: Available △: Although available, specifications such as setting method partially differ. ×: Not available

Function	Description	AnS series				QnAS series			
		A1SJHCPU A1SHCPU	A2SHCPU	A2USCPU	A2USHCPU-S1	Q2ASCPU Q2ASCPU-S1	Q2ASHCPU Q2ASHCPU-S1		
Number of device points (point)	Input device (X) ^{*12}	2048	2048	8192	8192	8192	8192		
	Output device (Y) ^{*12}	2048	2048	8192	8192	8192	8192		
	Internal relay (M)	Total 2048	Total 2048	Total 8192	Total 8192	8192	8192		
	Latch relay (L)					8192	8192		
	steps relay (S)					8192 ^{*13}	8192 ^{*13}		
	Annunciator (F)	256	256	2048	2048	2048	2048		
	Edge relay (V)	×	×	×	×	2048	2048		
	Link relay (B)	1024	1024	8192	8192	8192	8192		
	Timer (T)	256	256	2048 (default: 256)		2048	2048		
	Counter (C)	256	256	1024 (default: 256)		1024	1024		
	Data register (D)	1024	1024	8192	8192	12288	12288		
	Link register (W)	1024	1024	8192	8192	8192	8192		
	File register	(R)	8192	8192	8192	8192	32768 ^{*14}	32768 ^{*14}	
		(ZR)	×	×	×	×	Max. 1018K	Max. 1018K	
	Accumulator (A)	2	2	2	2	×	×		
	Index register	(Z)	1	1	7	7	16	16	
		(V)	1	1	7	7	×	×	
	Nesting (N)	8	8	8	8	15	15		
	Pointer (P)	256	256	256	256	4096	4096		
	Interrupt pointer (I)	32	32	32	32	48	48		
	Special relay (M/SM)	256	256	256	256	2048	2048		
	Special register (D/SD)	256	256	256	256	2048	2048		
	Special link relay (SB)	×	×	×	×	2048	2048		
Special link register (SW)	×	×	×	×	2048	2048			
Function input (FX)	×	×	×	×	16	16			
Function output (FY)	×	×	×	×	16	16			
Function register (FD)	×	×	×	×	5	5			
Number of comment points ^{*16}	Comment points	3648	3648	4032	4032	Max. approx.50K ^{*14*15}	Max. approx.50K ^{*14*15}		
	Extended comment	3968	3968	3968	3968	×	×		
Self-diagnostics	Watchdog timer (WDT), Memory error detection, CPU error detection, Battery error detection, etc.	○	○	○	○	○	○		
Operation mode at error occurrence	Stop/Continue setting	○	○	○	○	○	○		
Output mode switching at changing from STOP to RUN	Re-output operation status before STOP/Selection of output after operation execution	○	○	○	○	○	○		

○: Available △: Although available, specifications such as setting method partially differ. ×: Not available

Universal model QCPU								Precautions for replacement	Reference
Q00UJCPU	Q00UCPU	Q01UCPU	Q02UCPU	Q03UD(E)CPU/ Q03UDVCPU	Q04UD(E)HCPU/ Q04UDVCPU	Q06UD(E)HCPU/ Q06UDVCPU			
8192	8192	8192	8192	8192	8192	8192	8192	-	
8192	8192	8192	8192	8192	8192	8192	8192	-	
8192	8192	8192	8192	8192 (Q03UDCPU) 9216 (Q03UDVCPU)	8192 (Q04UDHCPU) 15360 (Q04UDVCPU)	8192 (Q06UDHCPU) 15360 (Q06UDVCPU)	-		
8192	8192	8192	8192	8192	8192	8192	-		
8192 ^{*13}	8192 ^{*13}	8192 ^{*13}	8192 ^{*13}	8192 ^{*13}	8192 ^{*13}	8192 ^{*13}	8192 ^{*13}	-	
2048	2048	2048	2048	2048	2048	2048	2048	-	
2048	2048	2048	2048	2048	2048	2048	2048	-	
8192	8192	8192	8192	8192	8192	8192	8192	-	
2048	2048	2048	2048	2048	2048	2048	2048	-	
1024	1024	1024	1024	1024	1024	1024	1024	-	
12288	12288	12288	12288	12288 (Q03UDCPU) 13312 (Q03UDVCPU)	12288 (Q04UDHCPU) 22528 (Q04UDVCPU)	12288 (Q06UDHCPU) 22528 (Q06UDVCPU)	-		
8192	8192	8192	8192	8192	8192	8192	8192	-	
×	32768	32768	32768	32768	32768	32768	32768	-	
×	65536	65536	65536 (capacity of memory card: +Max.4086K)	98304 (capacity of memory card ^{*17} : +Max.4086K)	131072 (capacity of memory card ^{*17} : +Max.4086K)	393216 (capacity of memory card ^{*17} : +Max.4086K)	-		
×	×	×	×	×	×	×	×	The QnAS/Q series CPU modules do not use the accumulator since the instruction format is different from that for the AnS series. Upon replacement, the accumulator is converted into the special register (SD718, SD719). Program modification is not required.	
20	20	20	20	20	20	20	20	-	
×	×	×	×	×	×	×	×	For the QnAS/Q series, this device is used as the edge relay.	
15	15	15	15	15	15	15	15	-	
512	512	512	4096	4096	4096	4096	4096	-	
128	128	128	256	256	256	256	256	-	
2048	2048	2048	2048	2048	2048	2048	2048	-	
2048	2048	2048	2048	2048	2048	2048	2048	-	
2048	2048	2048	2048	2048	2048	2048	2048	-	
2048	2048	2048	2048	2048	2048	2048	2048	-	
16	16	16	16	16	16	16	16	-	
16	16	16	16	16	16	16	16	-	
5	5	5	5	5	5	5	5	-	
Within program memory+ Standard ROM	Within program memory + Standard RAM ^{*18} + Standard ROM							-	
×	×	×	×	×	×	×	×	-	
○	○	○	○	○	○	○	○	-	
○	○	○	○	○	○	○	○	-	
○	○	○	○	○	○	○	○	-	

- *12 The points indicate the number of usable points in the program.
- *13 For the QnAS and Q series, the steps relay (S) is dedicated for SFC programs.
- *14 A memory card (sold separately) is required.
- *15 The points apply when the size of a memory card used is 2M bytes.
- *16 The number of comment points indicate the maximum number of points that can be written to the CPU module.
- *17 The High-speed Universal model QCPU (QnUDVCP) supports an SD memory card.
- *18 The High-speed Universal model QCPU (QnUDVCP) only can store data into the standard RAM.

(2) Comparison between AnS/QnASCPU and High Performance model QCPU

Function	Description	AnS/series				QnAS series		
		A1SJHCPU A1SHCPU	A2SHCPU	A2USCPU	A2USHCPU -S1	Q2ASCPU Q2ASCPU-S1	Q2ASHCPU Q2ASHCPU-S1	
Control method	Repetitive operation of stored program	○	○	○	○	○	○	
I/O control method	Refresh mode/direct mode	○ *1	○ *1	○ *2	○ *2	○ *2	○ *2	
Programming language	Language dedicated to sequence control (relay symbol, logic symbol, MELCAP language)	○	○	○	○	○	○	
Processing speed	Sequence instructions (μs/steps)	0.33	0.25	0.2	0.09	0.2	0.075	
Watchdog timer (WDT)	Watchdog timer (WDT) (ms)	10 to 2000	10 to 2000	200	200	10 to 2000	10 to 2000	
Memory capacity	User memory built-in capacity (byte)	64K (RAM) *3	64K (RAM) *3	64K (RAM) *3	256K (RAM) *3	Program memory (RAM) *7	Program memory (RAM) *7	
	Sold separately	Memory cassette ^{*4} (EEP-ROM)	Memory cassette ^{*4} (EEP-ROM)	Memory cassette ^{*4} (EEP-ROM)	Memory cassette ^{*4} (EEP-ROM)	Memory card (Max. 2M)	Memory card (Max. 2M)	
Program capacity	Sequence program (steps)	Max. 8K	Max. 14K	Max. 14K	Max. 30K	Max. 28K (-S1: 60K)	Max. 28K (-S1: 60K)	
	Microcomputer program (byte)	Max. 14K ^{*8}	Max. 26K ^{*8}	×	×	×	×	
Number of I/O points	Number of I/O points (point) ^{*6}	256	512	512	1024	512 (-S1:1024)	512 (-S1:1024)	

- *1 I/O control mode (refresh mode or direct mode) is selectable with the I/O control method setting switch.
- *2 Only refresh mode is available, but there are instructions and devices that can use direct mode.
- *3 Free space areas (except that in the program memory) can be used as user memory.
- *4 Memory cassette is for copying programs to the ROM. Use of the cassette does not increase the memory capacity.
- *5 Only one memory card can be used.
- *6 This number means the number of applicable points for the access to actual I/O modules.
- *7 The memory capacity corresponds to the maximum number of steps in a sequence program.
- *8 The program capacity is included to a sequence program.

○: Available △: Although available, specifications such as setting method partially differ. ×: Not available

	Basic model QCPU			High Performance model QCPU			Precautions for replacement	Reference
	Q00JCPU	Q00CPU	Q01CPU	Q02CPU	Q02HCPU	Q06HCPU		
	○	○	○	○	○	○	-	-
	○ *2	○ *2	○ *2	○ *2	○ *2	○ *2	For the Q series, only refresh mode is available. To input or output data in direct mode, use the direct input/output dedicated instructions.	-
	○	○	○	○	○	○	The MELSAP language for the A/AnS series is MELSAP-II and that for the QnA/Q2AS/Q series is MELSAP3.	-
	0.2	0.16	0.1	0.079	0.034	0.034	-	-
	10 to 2000	10 to 2000	10 to 2000	10 to 2000	10 to 2000	10 to 2000	-	-
	• Program memory (RAM) ^{*7} 58K • Standard ROM ^{*7} : 58K	• Program memory (RAM) ^{*7} 94K • Standard ROM ^{*7} : 94K • Standard RAM 128K	• Program memory (RAM) ^{*7} 94K • Standard ROM ^{*7} : 94K • Standard RAM 128K	• Program memory (RAM) ^{*7} 112K • Standard ROM ^{*7} : 112K • Standard RAM 64K	• Program memory (RAM) ^{*7} 112K • Standard ROM ^{*7} : 112K • Standard RAM 128K	• Program memory (RAM) ^{*7} 240K • Standard ROM ^{*7} : 240K • Standard RAM 128K	-	Section 2.4.1
	-	-	-	Memory card ^{*5} RAM: Max. 2M Flash : Max. 4M ATA: Max. 32M	Memory card ^{*5} RAM: Max. 2M Flash: Max. 4M ATA: Max. 32M	Memory card ^{*5} RAM: Max. 2M Flash: Max. 4M ATA: Max. 32M	-	-
	Max. 8K	Max. 8K	Max. 14K	Max. 28K	Max. 28K	Max. 60K	-	-
	×	×	×	×	×	×	For the Q series, microcomputer programs cannot be used. Consider replacing those microcomputer programs with sequence programs.	-
	256	1024	1024	4096	4096	4096	-	-

○: Available △: Although available, specifications such as setting method partially differ. ×: Not available

Function	Description	AnS series				QnAS series			
		A1SJHCPU A1SHCPU	A2SHCPU	A2USCPU	A2USHCPU -S1	Q2ASCPU Q2ASCPU-S1	Q2ASHCPU Q2ASHCPU-S1		
Number of device points (point)	Input device (X) ^{*9}	2048	2048	8192	8192	8192	8192		
	Output device (Y) ^{*9}	2048	2048	8192	8192	8192	8192		
	Internal relay (M)	Total 2048	Total 2048	Total 8192	Total 8192	8192	8192		
	Latch relay (L)					8192	8192		
	steps relay (S)					8192 ^{*10}	8192 ^{*10}		
	Annunciator (F)	256	256	2048	2048	2048	2048		
	Edge relay (V)	×	×	×	×	2048	2048		
	Link relay (B)	1024	1024	8192	8192	8192	8192		
	Timer (T)	256	256	2048 (default: 256)		2048	2048		
	Counter (C)	256	256	1024 (default: 256)		1024	1024		
	Data register (D)	1024	1024	8192	8192	12288	12288		
	Link register (W)	1024	1024	8192	8192	8192	8192		
	File register	(R)	8192	8192	8192	8192	32768 ^{*11}	32768 ^{*11}	
		(ZR)	×	×	×	Max. 120K	Max. 1018K	Max. 1018K	
	Accumulator (A)		2	2	2	2	×	×	
	Index register	(Z)	1	1	7	7	16	16	
		(V)	1	1	7	7	×	×	
	Nesting (N)		8	8	8	8	15	15	
	Pointer (P)		256	256	256	256	4096	4096	
	Interrupt pointer (I)		32	32	32	32	48	48	
	Special relay (M/SM)		256	256	256	256	2048	2048	
	Special register (D/SD)		256	256	256	256	2048	2048	
	Special link relay (SB)		×	×	×	×	2048	2048	
	Special link register (SW)		×	×	×	×	2048	2048	
	Function input (FX)		×	×	×	×	16	16	
	Function output (FY)		×	×	×	×	16	16	
Function register (FD)		×	×	×	×	5	5		
Number of comment points ^{*13}	Comment points	3648	3648	3648	4032	Max. approx. 50K ^{*11 *12}	Max. approx. 50K ^{*11 *12}		
	Extended comment	×	×	×	3968	×	×		
Self-diagnostics	Watchdog timer (WDT), Memory error detection, CPU error detection, Battery error detection, etc.	○	○	○	○	○	○		
Operation mode at error occurrence	Stop/Continue setting	○	○	○	○	○	○		
Output mode switching at changing from STOP to RUN	Re-output operation status before STOP/Selection of output after operation execution	○	○	○	○	○	○		

*9 The points indicate the number of usable points in the program.

*10 For the QnAS and Q series, the steps relay (S) is dedicated for SFC programs.

*11 A memory card (sold separately) is required.

*12 The points apply when the size of a memory card used is 2M bytes.

*13 The number of comment points indicate the maximum number of points that can be written to the CPU module.

○: Available △: Although available, specifications such as setting method partially differ. ×: Not available

	Basic model QCPU			High Performance model QCPU			Precautions for replacement	Reference
	Q00JCPU	Q00CPU	Q01CPU	Q02CPU	Q02HCPU	Q06HCPU		
	2048	2048	2048	8192	8192	8192	-	-
	2048	2048	2048	8192	8192	8192	-	-
	8192	8192	8192	8192	8192	8192	-	-
	2048	2048	2048	8192	8192	8192	-	-
	2048 ^{*10}	2048 ^{*10}	2048 ^{*10}	8192 ^{*10}	8192 ^{*10}	8192 ^{*10}	-	-
	1024	1024	1024	2048	2048	2048	-	-
	1024	1024	1024	2048	2048	2048	-	-
	2048	2048	2048	8192	8192	8192	-	-
	512	512	512	2048	2048	2048	-	-
	512	512	512	1024	1024	1024	-	-
	11136	11136	11136	12288	12288	12288	-	-
	2048	2048	2048	8192	8192	8192	-	-
	×	32768	32768	32768	32768	32768	-	-
	×	65536	65536	32768 (capacity of memory card: + max. 1018K)	65536 (capacity of memory card: + max. 1018K)	65536 (capacity of memory card: + max. 1018K)	-	-
	×	×	×	×	×	×	The QnAS/Q series CPU modules do not use the accumulator since the instruction format is different from that for the AnS series. Upon replacement, the accumulator is converted into the special register (SD718, SD719). Program modification is not required.	-
	10	10	10	16	16	16	-	-
	×	×	×	×	×	×	For the QnAS/Q series, this device is used as the edge relay.	-
	15	15	15	15	15	15	-	-
	300	300	300	4096	4096	4096	-	-
	128	128	128	256	256	256	-	-
	1024	1024	1024	2048	2048	2048	-	-
	1024	1024	1024	2048	2048	2048	-	-
	1024	1024	1024	2048	2048	2048	-	-
	1024	1024	1024	2048	2048	2048	-	-
	16	16	16	16	16	16	-	-
	16	16	16	16	16	16	-	-
	5	5	5	5	5	5	-	-
	Within the free area size of the program memory	Within standard RAM capacity	Within standard RAM capacity	Max. approx. 50K	Max. approx. 50K	Max. approx. 50K	-	-
	×	×	×	×	×	×	-	-
	○	○	○	○	○	○	-	-
	○	○	○	○	○	○	-	-
	○	○	○	○	○	○	-	-

2.3 Functional Comparison of CPU Module

2.3.1 Functional comparison between AnS series and Q series

(1) Comparison between QnASCPU and Universal model QCPU

○: Available △: Although available, specifications such as setting method partially differ. ×: Not available

Function	Description	AnS series		Q series	Precautions for replacement	Reference
		AnSHCPU	A2USCPU A2USHCPU -S1	Universal model ^{*1}		
Control	Constant scan	○	○	△	Set this function with the special register (D9020) for the AnS series, and with parameters for the Q series.	-
	Latch (data retention during power failure)	○	○	○	-	-
	Remote RUN/STOP	○	○	○	-	-
	PAUSE	○	○	△	Set the PAUSE enable flag with the special relay (M9040) for the AnS/A2US series and with the special relay (SM206) for the Q series. ^{*2}	-
	Interrupt processing	○	○	○	-	-
	Microcomputer mode	○	○	×	Consider use of sequence program, etc., as the substitution. Instructions from any utility package need to be replaced with the corresponding instructions of the QCPU.	-
	Display of priority of ERROR LED	○	○	○	Target errors vary for each module, but there is no functional difference.	-
	ROM operation	○	○	△	AnS series CPU modules can perform the ROM operation by using EEP-ROM cassette (sold separately). The Universal model QCPU, whose program memory is a Flash ROM, does not have to perform the ROM operation.	Section 7.7.12

*1 Universal model QCPU refers Q00UJCPU, Q00UCPU, Q01UCPU and others QnUCPUs.

*2 When PLC type in GX Developer changes, the number of device will change.

○: Available △: Although available, specifications such as setting method partially differ. ×: Not available

Function	Description	AnS series		Q series	Precautions for replacement	Reference
		AnSHCPU	A2USCPU A2USHCPU -S1	High Performance model*1		
Control	Data protection function (system protection, keyword registration/ password registration)	○	○	△	The Q series prohibits each file from being read/written by password registration, whereas the AnS series prohibit the parameters and programs from being read/written to the user memory by keyword registration.	Section 2.4.2
	Output status setting at changing from STOP to RUN	○	○	○	To replace the AnS series, resetting the parameters is necessary.	-
	Clock function	○	△	△	The Q series handles the year in four digits (western calendar), whereas the AnS series handles the year in the last two digits.	-
Debug	Write during RUN	○	○	○*3	For the Q series, it is necessary to set the reserved capacity for the write during RUN in advance.	Section 2.4.3
	Status latch	○	○	×	The Q series does not support the status latch function.	-
	Sampling trace	○	○	○*4	-	-
	steps operation	○	○	×	The Q series does not support the steps operation function. This function can be substituted by the force external I/O ON/OFF function.	-
	Off-line switch	○	○	×	The Q series does not support the off-line switch function.	-
Maintenance	Online I/O module change	×	×	×	To replace the input/output modules online, use the Process CPU.	-
	Self-diagnostic function	○	○	○	Error codes differ between the AnS series and Q series.	-

*1 Universal model QCPU refers Q00UJCPU, Q00UCPU, Q01UCPU and others QnUCPUs.

*3 It is necessary to set the reserved capacity for the write during RUN in advance. (Default-set to 500 steps.)

*4 The function is not provided in Q00UJCPU.

(2) Comparison between AnSCPU and Basic model QCPU, High Performance model QCPU

○: Available △: Although available, specifications such as setting method partially differ. ×: Not available

Function	Description	AnS series		Q series		Precautions for replacement	Reference
		AnSHCPU	A2USCPU A2USHCPU -S1	Basic model*1	High Performance model*2		
Constant scan	Executes the sequence program at constant time intervals regardless of the processing time of the program.	○	○	△	△	Set this function with the special register (D9020) for the AnS series, and with parameters for the Q series.	-
Latch (data retention during power failure)	Holds the data of devices when turning off the power, resetting, and a momentary power failure longer than the allowable momentary power failure time occurs.	○	○	○	○	-	-
Remote RUN/STOP	Remotely runs or stops the program operations in the CPU module from external switches or peripherals.	○	○	○	○	-	-
PAUSE	Stops operations while holding the output status.	○	○	△	△	Set the PAUSE enable flag with the special relay (M9040) for the AnS series, and with the special relay (SM206) for the Q series.*3	-
Interrupt processing	Executes the program that corresponds to the cause when an interrupt cause occurs.	○	○	○	○	-	-
Microcomputer mode	Executes various controls and operations over utility programs and user created microcomputer programs stored in the microcomputer program area by calling them from the sequence program.	○	×	×	×	Consider use of sequence program, etc., as the substitution. Instructions from any utility package need to be replaced with the corresponding instructions of the QCPU.	-
Display of priority of ERROR LED	Sets the ERROR LED on/off status at an error.	○	○	○	○	Target errors vary for each module, but there is no functional difference.	-
ROM operation	Enables operation with parameters and programs stored in ROM not to lose user programs due to battery exhaustion.	○	○	△	△	For the AnS series CPU modules, an E ² PROM cassette (sold separately) is required for copying data to the ROM for ROM operation. The High Performance model QCPU modules have the boot operation function, which reads sequence programs stored in the built-in standard ROM or memory card to the program memory to perform ROM operation.	Section 2.4.1 Section 7.7.12

*1 The "Basic model" is a generic term of Q00JCPU, Q00CPU and Q01CPU.

*2 The "High Performance model" is the generic term of Q02CPU, Q02HCPU, Q06HCPU, Q12HCPU, and Q25HCPU.

*3 Device numbers are converted upon the programmable controller type change by GX Developer.

○: Available △: Although available, specifications such as setting method partially differ. ×: Not available

Function	Description	AnS series		Q series		Precautions for replacement	Reference
		AnSHCPU	A2USCPU A2USHCPU -S1	Basic model*1	High Per- formance model*2		
Control	Data protection function (system protection, keyword registration/ password registration)	○	○	△	△	The Q series prohibits each file from being read/written by password registration, whereas the AnS series prohibit the parameters and programs from being read/written to the user memory by keyword registration.	Section 2.4.2
	Output status setting at changing from STOP to RUN	○	○	○	○	To replace the AnS series, resetting the parameters is necessary.	-
	Clock function	○	○	△	△	The Q series handles the year in four digits (western calendar), whereas the AnS series handles the year in the last two digits.	-
Debug	Write during RUN	○	○	○*4	○*4	For the Q series, it is necessary to set the reserved capacity for the write during RUN in advance.	Section 2.4.3
	Status latch	○	○	×	×	The Q series does not support the status latch function.	-
	Sampling trace	○	○	×	○*5	-	-
	steps operation	○	○	×	×	The Q series does not support the steps operation function. Consider debugging with GX Simulator.	-
	Off-line switch	○	○	×	×	The Q series does not support the off-line switch function.	-
Maintenance	Online I/O module change	×	×	×	×	To replace the input/output modules online, use the Process CPU.	-
	Self-diagnostic function	○	○	○	○	Error codes differ between the AnS series and Q series.	-

*1 The "Basic model" is a generic term of Q00JCPU, Q00CPU and Q01CPU.

*2 The "High Performance model" is the generic term of Q02CPU, Q02HCPU, Q06HCPU, Q12HCPU, and Q25HCPU.

*4 It is necessary to set the reserved capacity for the write during RUN in advance. (Default-set to 500 steps.)

*5 The function is not provided in Q00JCPU.

2.3.2 Functional comparison between QnAS series and Q series

(1) Comparison between QnASCPU and Universal model QCPU

○: Available △: Although available, specifications such as setting method partially differ. ×: Not available

Function	Description	QnAS series	Q series	Precautions for replacement	Reference
		Q2ASCPU (S1) Q2ASHCPU (S1)	Universal model ^{*1}		
Control	Constant scan	○	○	-	-
	Latch (data retention during power failure)	○	○	-	-
	Remote RUN/STOP	○	○	-	-
	PAUSE	○	○	-	-
	Interrupt processing	○	○	-	-
	Display priority of ERROR LED	○	○	Target errors vary by model, but there is no functional difference.	-
	File management	○	○	Memory configuration and data to be stored differ between the QnAS series and Q series.	Section 2.4.1
	Structured program	○	○	-	-
	I/O assignment	○	△	When using a base unit with other than 8 slots, set the number of slots with the parameter (I/O assignment setting).	Section 2.4.4
	Boot operation (ROM operation)	○	△	The Universal model QCPU, whose program memory is a Flash ROM, does not have to perform the ROM operation.	Section 2.4.1 Section 7.7.12
Data protection function (system protection, keyword registration/password registration)	○	△	The Q series prohibits each file from being read/written by password registration, whereas the QnAS series prohibit the parameters and programs from being read/written to the user memory by keyword registration.	Section 2.4.2	
Initial device value	○	○	Memory configuration and data to be stored differ between the QnAS series and Q series.	Section 2.4.1	
Output status setting at changing from STOP to RUN	○	○	Resetting parameters is required to replace the QnAS series with the Q series.	-	

*1 Universal model QCPU refers Q00UJCPU, Q00UCPU, Q01UCPU and others QnUCPUs.

○: Available △: Although available, specifications such as setting method partially differ. ×: Not available

Function	Description	QnA series	Q series	Precautions for replacement	Reference
		Q2ASCPU (S1) Q2ASHCPU (S1)	Universal model ^{*1}		
Control	Number of general data processing	○	△	For the Q series, use the COM instructions or set the communication reserved time with special register (SD315) if necessary.	-
	Clock function	○	△	The Q series handles the year in four digits (western calendar), whereas the QnAS series handles the year in the last two digits. Pay attention to the handling of the day of the week data.	-
Debug	Write during RUN	○ ^{*2}	○ ^{*2}	For the Q series, it is necessary to set the reserved capacity for the write during RUN in advance.	Section 2.4.3
	Status latch	○ ^{*3 *4}	×	The Q series does not support the status latch function.	-
	Sampling trace	○ ^{*3}	○ ^{*5}	-	-
	Program trace	○ ^{*3 *4}	×	The Q series does not support the program trace function.	-
	Simulation function	○ ^{*3 *4}	×	The Q series does not support the simulation function. Consider debugging with GX Simulator.	-
	steps operation	○	×	The Q series does not support the steps operation function. Consider debugging with GX Simulator.	-
	Execution time measurement (program monitor list, scan time measurement)	○	○	The execution time measurement can be checked on the Program monitor list screen of GX Developer ^{*6} .	-
	Module access interval read	○	○	^{*7}	-
	Online I/O module change	○	×	To replace the input/output modules online, use the Process CPU.	-
Maintenance	Self-diagnostic function	○	○	Error codes differ between the QnAS series and Q series.	-
	Error history	○	○	-	-

- *1 Universal model QCPU refers Q00UJCPU, Q00UCPU, Q01UCPU and others QnUCPUs.
- *2 It is necessary to set the reserved capacity for the write during RUN in advance. (Default-set to 500 steps.)
- *3 A SRAM card is required.
- *4 SW□IVD/NX-GPPQ is required.
- *5 The function is not provided in Q00UJCPU.
- *6 The High-speed Universal model QCPU (QnUDVCPU) is supported only by GX Works2.
- *7 It is said "Module service interval time" in Q series.

(2) Comparison between QnASCPU and High Performance model QCPU

○: Available △: Although available, specifications such as setting method partially differ. ×: Not available

Function	Description	QnAS series	Q series	Precautions for replacement	Reference
		Q2ASCPU (S1) Q2ASHCPU (S1)	High Performance model*1		
Control	Constant scan	○	○	-	-
	Latch (data retention during power failure)	○	○	-	-
	Remote RUN/STOP	○	○	-	-
	PAUSE	○	○	-	-
	Interrupt processing	○	○	-	-
	Display priority of ERROR LED	○	○	Target errors vary by model, but there is no functional difference.	-
	File management	○	○	Memory configuration and data to be stored differ between the QnAS series and Q series.	Section 2.4.1
	Structured program	○	○	-	-
	I/O assignment	○	△	When using a base unit with other than 8 slots, set the number of slots with the parameter (I/O assignment setting).	Section 2.4.4
	Boot operation (ROM operation)	○	△	The High Performance model QCPU modules have the boot operation function, which reads sequence programs stored in the built-in standard ROM or memory card to the program memory to perform ROM operation.	Section 2.4.1 Section 7.7.12
	Data protection function (system protection, keyword registration/ password registration)	○	△	The Q series prohibits each file from being read/written by password registration, whereas the QnAS series prohibit the parameters and programs from being read/written to the user memory by keyword registration.	Section 2.4.2
	Initial device value	○	○	Memory configuration and data to be stored differ between the QnAS series and Q series.	Section 2.4.1
Output status setting at changing from STOP to RUN	○	○	Resetting parameters is required to replace the QnAS series with the Q series.	-	

*1 The "High Performance model" is the generic term of Q02CPU, Q02HCPU, Q06HCPU, Q12HCPU, and Q25HCPU.

○: Available △: Although available, specifications such as setting method partially differ. ×: Not available

Function	Description	QnA series	Q series	Precautions for replacement	Reference
		Q2ASCPU (S1) Q2ASHCPU (S1)	High Performance model*1		
Control	Number of general data processing	○	△	For the Q series, use the COM instructions or set the communication reserved time with special register (SD315) if necessary.	-
	Clock function	○	△	The Q series handles the year in four digits (western calendar), whereas the QnAS series handles the year in the last two digits. Pay attention to the handling of the day of the week data.	-
Debug	Write during RUN	○*2	○*2	For the Q series, it is necessary to set the reserved capacity for the write during RUN in advance.	Section 2.4.3
	Status latch	○*3 *4	×	The Q series does not support the status latch function.	-
	Sampling trace	○*3	○*5	-	-
	Program trace	○*3 *4	×	The Q series does not support the program trace function.	-
	Simulation function	○*3 *4	×	The Q series does not support the simulation function. Consider debugging with GX Simulator.	-
	steps operation	○	×	The Q series does not support the steps operation function. Consider debugging with GX Simulator.	-
	Execution time measurement (program monitor list, scan time measurement)	○	○	The execution time measurement can be checked on the Program monitor list screen of GX Developer.	-
	Module access interval read	○	○	*6	-
	Online I/O module change	○	×	To replace the input/output modules online, use the Process CPU.	-
Maintenance	Self-diagnostic function	○	○	Error codes differ between the QnAS series and Q series.	-
	Error history	○	○	-	-

- *1 The "High Performance model" is the generic term of Q02CPU, Q02HCPU, Q06HCPU, Q12HCPU, and Q25HCPU.
- *2 It is necessary to set the reserved capacity for the write during RUN in advance. (Default-set to 500 steps.)
- *3 A SRAM card is required.
- *4 SW□IVD/NX-GPPQ is required. This is not applicable to GX Developer.
- *5 The function is not provided in Q00JCPU.
- *6 It is said "Module service interval time" in Q series.

2.4 Precautions for CPU Module Replacement

2.4.1 Memory for CPU module

The memory configuration is shown in (1). Examine the following points depending on the memory capacity before replacement and applications.

- Memory to store
- To use or not to use a memory card

(1) Memory configuration and data that can be stored

(a) Universal model QCPU

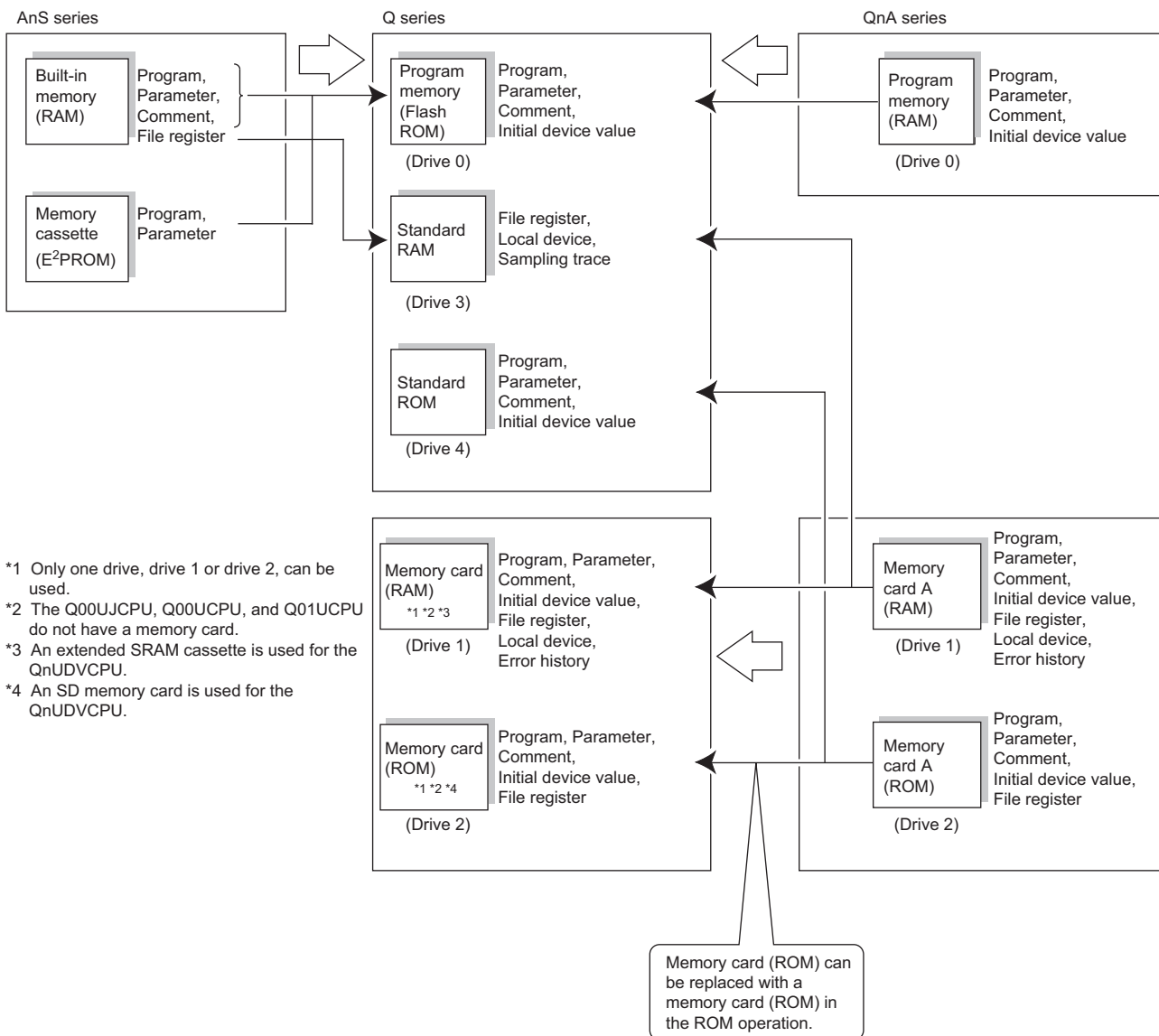

(b) High Performance model QCPU

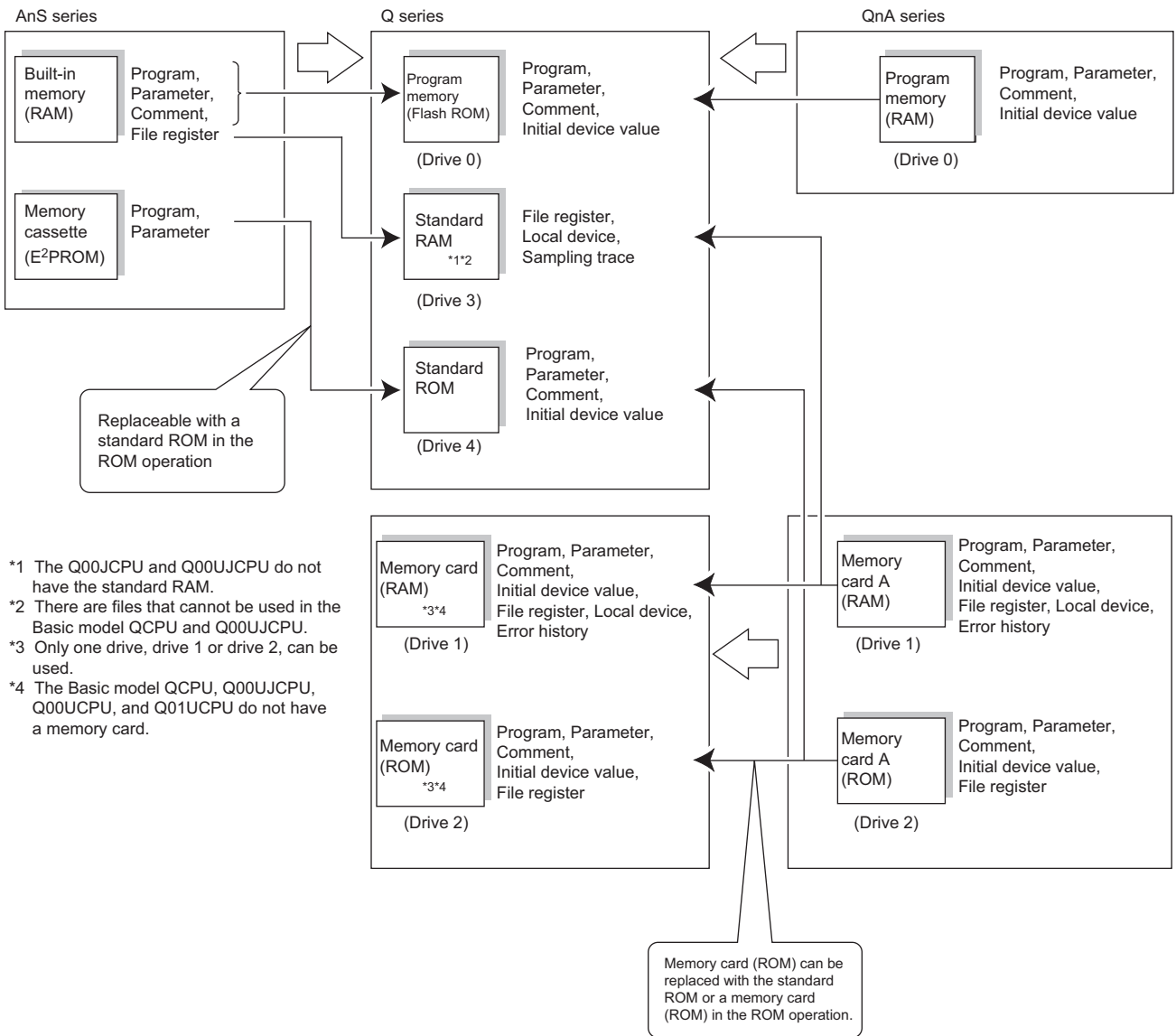

(2) Capacity of each memory

The following table shows the memory of CPU modules, in which the user program, etc. is stored, together with its capacity.

(The memory capacity of each item is different according to CPU type. Please refer to the manual of corresponding CPU.)

Item		Model				
		AnS series	QnAS series	Q series		
				High-speed Universal model QCPU (QnUDVCPU)	Universal model (excluding QnUDVCPU)	High performance model
Built-in RAM		Max. 64K bytes (A2USHCPU-S1: 256K bytes)	Max. 240K bytes (program memory)	Max. 1040K bytes (program memory)	Max. 4000K bytes (program memory)	Max. 1008K bytes (program memory)
Memory cassette	E ² PROM	32K bytes (for writing programs to ROM)	-	-	-	
	SRAM cassette	-	-	8M bytes		
Memory card	SRAM card	-	Max. 2M bytes	-	Max. 8M bytes	Max. 2M bytes
	E ² PROM card	-	Max. 512K bytes	-	-	
	Flash card	-	Max. 1M byte	-	Max. 4M bytes	
	ATA card	-	-	-	Max. 32M bytes	
	SD memory card	-	-	Max. 4G bytes	-	
Standard RAM		-	-	Max. 1280K bytes	Max. 1792K bytes (Q00UJCPU: none)	Max. 256K bytes (Q00JCPU: none)
Standard ROM		-	-	Max. 4102K bytes	Max. 16384K bytes	Max. 1008K bytes

2.4.2 Keyword registration and password registration

The Q series prohibits reading from/writing to programs, etc. when a password is registered, as do the AnS/QnAS series with keyword registration. Available functions are described below.

Item	Model		
	AnS series	QnAS series	Q series
Prohibition method for writing to program, etc.	<p>The following attribute can be set to the specified memory.</p> <ul style="list-style-type: none"> Prohibition of read/write 	<p>Either of the following attributes can be set to the specified memory (drive).</p> <ul style="list-style-type: none"> Prohibition of read/write/display Prohibition of write 	<p>Batch password setting for all files provides the equivalent function. (Supplement)</p> <p>By using a password, the following attributes can be set to each specified file of the specified memory (drive).</p> <ul style="list-style-type: none"> Prohibition of read/write/display Prohibition of write

2.4.3 Write during RUN

To execute the write during RUN, it is necessary to reserve the program size for increase upon the write during RUN in advance.

(1) AnS series

The program size is decided by the parameter (memory capacity setting), and can be increased within the capacity range upon write during RUN.

(2) QnAS/Q series

It is necessary to set the program size for increase upon the write during RUN in the Write to PLC screen. (This set capacity is called as the write during RUN reserved steps. By default, 500 steps are reserved.)

The following shows the setting screen for Allocate memory for Write during RUN as a reference.

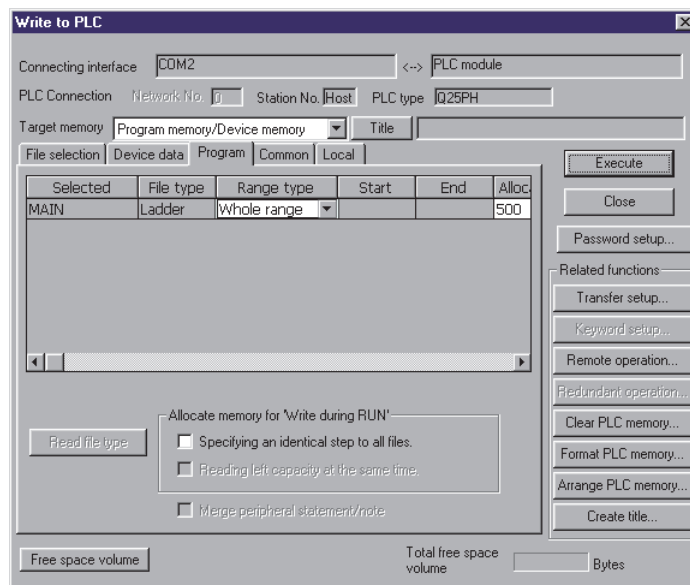

2.4.4 Number of slots on the base unit

The following table shows how to determine the number of slots on the base unit for each series.

Item	Model		
	AnS series	QnAS series	Q series
Number of slots on the base unit	Fixed to 8 slots regardless of the actual number.		Same as the actual number of slots. (The number of slots can be determined in the parameter setting.) (Supplement) If other than 8-slot base unit is used in the Q series after replacement, set the start XY address of each slot or set the number of slots to "8" in the I/O assignment tab of the PLC parameter dialog box.

The following gives an example of replacing the A1S35B+A1S68B system (default parameter is used) with the Q35B+Q68B system.

(I/O assignment for the AnS series before replacement)

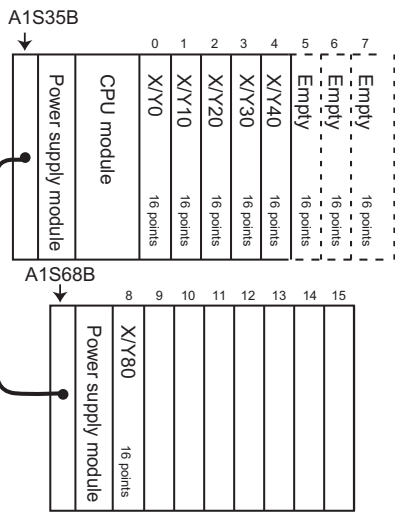

(I/O assignment for the Q series after replacement)

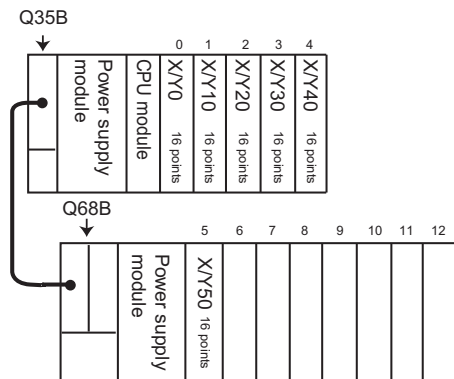

After replacement, the start I/O numbers of the first extension base unit will be "X/Y50".

(1) Setting the start XY address of each slot

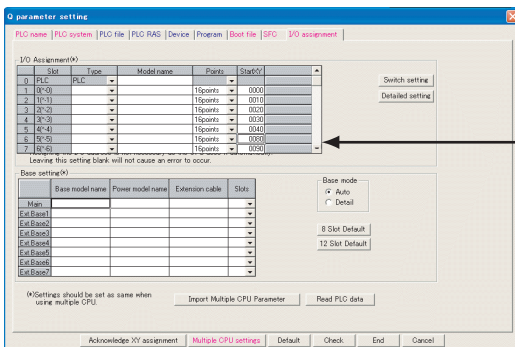

(2) Setting the number of slots to "8"

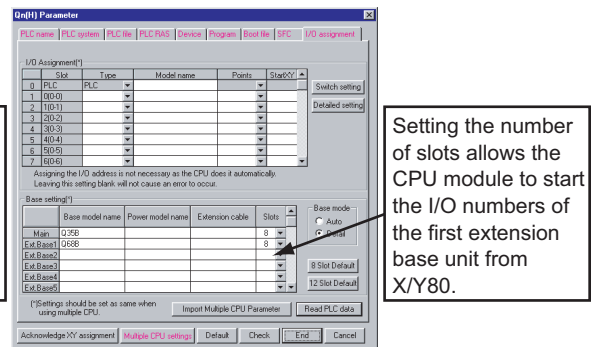

(I/O assignment for the Q series when the start XY address of each slot is set after replacement)

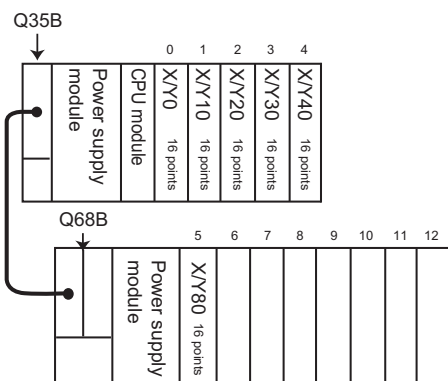

(I/O assignment for the Q series when the number of slots of the base unit is set after replacement)

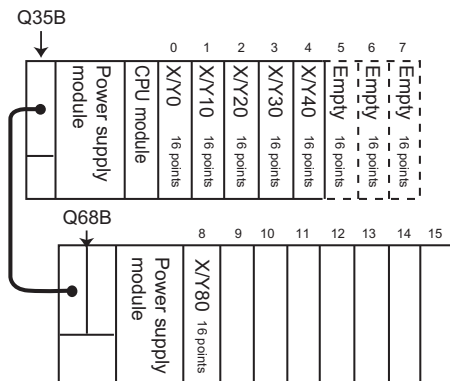

2.4.5 Base unit compatible with QCPU

The following table shows the base unit compatible with each QCPU type when replacing A/AnS/QnA/QnAS series with Q series.

Function		Base unit			
		Main base unit	Slim type main base unit *1	Extension base unit	
		Q3□B	Q3□SB	Q6□B	
Universal model QCPU	Q00UJCPU*4	-	-	○	
	Q00UCPU	○	○	○	
	Q01UCPU	○	○	○	
	Q02UCPU	○	○	○	
	Q03UD(E)CPU/ Q03UDVCPU	○	○	○	
	Q04UD(E)HCPU/ Q04UDVCPU	○	○	○	
	Q06UD(E)HCPU/ Q06UDVCPU	○	○	○	
High Performance model QCPU	Q02(H)CPU	○	○	○	
	Q06HCPU	○	○	○	
	Q12HCPU	○	○	○	
Basic model QCPU	Q00JCPU*4	-	-	○	
	Q00CPU	○	○	○	
	Q01CPU	○	○	○	
Process CPU		○	×	○	
Redundant CPU (Q series)*5		-	-	-	
MELSECNET/10 remote I/O station	QJ72LP25-25	○	○	○	
	QJ72BR15	○	○	○	

*1 The extension base unit can not be connected.

*2 Q large type main base unit can not be used in a multiple CPU system.

*3 QA1S6□B can not be used together with QA6ADP.

*4 The CPU module includes power supply module and base unit.

*5 A base unit for a redundant system is required.

*6 When the QA(1S) extension base unit is used with Universal model QCPU, the serial number (first five digits) must be "13102" or later.

*7 The QA1S51B is not extendable. (Since the QA1S51B does not have an extension cable connector (OUT), it cannot be used with the QA6□B or QA6ADP+A5□B/A6□B.)

○ : Available △ : Not available (Planned to support in the future.) × : Not available

	Q large base unit		QA(1S) extension base unit			QA conversion adapter
	Q large main base unit ^{*2}	Q large extension base unit	QA extension base unit	QA1S extension base unit	QA1S extension base unit	A (large type) base unit+QA conversion adapter ^{*3}
	Q3□BL	Q6□BL	QA6□	QA1S51B	QA1S6□B	QA6ADP
	-	×	○ ^{*6}	○ ^{*6*7}	○ ^{*6}	×
	○	○	○ ^{*6}	○ ^{*6*7}	○ ^{*6}	×
	○	○	○ ^{*6}	○ ^{*6*7}	○ ^{*6}	×
	○	○	○ ^{*6}	○ ^{*6*7}	○ ^{*6}	×
	○	○	○ ^{*6}	○ ^{*6*7}	○ ^{*6}	×
	○	○	○ ^{*6}	○ ^{*6*7}	○ ^{*6}	×
	○	○	○ ^{*6}	○ ^{*6*7}	○ ^{*6}	×
	○	○	○	○ ^{*7}	○	○
	○	○	○	○ ^{*7}	○	○
	○	○	○	○ ^{*7}	○	○
	-	×	×	×	×	×
	×	×	×	×	×	×
	×	×	×	×	×	×
	×	×	×	×	×	×
	-	-	-	-	-	-
	○	○	×	×	×	×
	○	○	×	×	×	×

2.4.6 Programming tool and connection cable for Q series CPU

(1) Programming tool for Q series CPU

At the transition from MELSEC AnS/QnAS series to Q series, programming (including a programmable controller type change for utilizing programs) for Q series CPUs is performed using GX Developer. In this handbook, GX Developer is used as a programming tool. Software packages other than GX Developer cannot be used.

Remarks

The existing programs for the A/QnA CPU module cannot be used in GX Works2, because GX Works2 does not support the A/QnA series. Change "PLC type" again after changing the existing program into QCPU by "Change PLC type" and opening the program for the Q series on GX Works2.

(2) Connection cable for Q series CPU

When connecting a personal computer in which GX Developer has been installed to the Q series CPU, RS-232 connection, USB connection, and Ethernet connection are available. The availability depending on CPU model is shown in the following table. Note that the RS-232/RS-422 conversion cable for the AnS/QnAS series CPU are not applicable.

(a) Universal model QCPU

CPU model	RS-232 connection	USB connection	Ethernet connection
Q00JCPU Q00UCPU Q01UCPU Q02UCPU Q03UDCPU/Q04UDHCPU/ Q06UDHCPU	Available*1	Available (USB A type-USB miniB type)	Not available
Q03UDECPU Q04UDEHCPU/Q04UDVCPU Q06UDEHCPU/Q06UDVCPU Q10UDEHCPU/Q10UDVCPU Q13UDEHCPU/Q13UDVCPU	Not available		Available

*1 Applicable cable is the QC30R2.

(b) Basic model QCPU, High Performance model QCPU

CPU model	RS-232 connection	USB connection
Q00JCPU Q00CPU Q01CPU Q02CPU	Available*1	Unavailable
Q02HCPU Q06HCPU Q12HCPU Q12PHCPU Q25HCPU Q25PHCPU		Available (USB A type-USB miniB type)

*1 Applicable cable is the QC30R2.

Refer to GX Developer Operating Manual for details.

3 REPLACEMENT OF I/O MODULE

3.1 List of Alternative Models of I/O Module

AnS/QnAS series model		Q series alternative model	
Product	Model	Model	Remarks (restrictions)
Input module	A1SX10	QX10	1) External wiring: changed 2) Number of slots: not changed 3) Program Number of occupied I/O points: not changed 4) Specifications Rated input voltage: not changed Rated input current: changed On voltage/on current: not changed Off voltage/off current: changed Input resistance: changed 5) Function: not changed
	A1SX10EU	QX10	1) External wiring: changed 2) Number of slots: not changed 3) Program Number of occupied I/O points: not changed 4) Specifications Rated input voltage: not changed Rated input current: changed On voltage/on current: not changed Off voltage/off current: changed Input resistance: changed 5) Function: not changed
	A1SX20	QX28	1) External wiring: changed 2) Number of slots: changed (2 modules are required.) 3) Program Number of occupied I/O points: changed (16 points → 32 points (16 points × 2 modules)) 4) Specifications Rated input voltage: not changed Rated input current: changed On voltage/on current: changed Off voltage/off current: changed Input resistance: changed 5) Function: not changed
	A1SX20EU	QX28	1) External wiring: changed 2) Number of slots: changed (2 modules are required.) 3) Program Number of occupied I/O points: changed (16 points → 32 points (16 points × 2 modules)) 4) Specifications Rated input voltage: not changed Rated input current: changed On voltage/on current: changed Off voltage/off current: changed Input resistance: changed 5) Function: not changed

AnS/QnAS series model		Q series alternative model	
Product	Model	Model	Remarks (restrictions)
Input module	A1SX30*1	QX40 (24VDC, positive common)	1) External wiring: changed 2) Number of slots: not changed 3) Program Number of occupied I/O points: not changed 4) Specifications Rated input voltage: changed (12VDC and AC input are not applicable.) Rated input current: changed On voltage/on current: changed Off voltage/off current: changed Input resistance: changed 5) Function: not changed [When applying AC input] Convert 24VAC to DC externally before input to the QX40.
	A1SX40	QX40 (24VDC)	1) External wiring: changed 2) Number of slots: not changed 3) Program Number of occupied I/O points: not changed 4) Specifications Rated input voltage: changed (12VDC is not applicable.) Rated input current: changed On voltage/on current: changed Off voltage/off current: changed Input resistance: changed 5) Function: not changed
		QX70 (12VDC)	1) External wiring: changed 2) Number of slots: not changed 3) Program Number of occupied I/O points: not changed 4) Specifications Rated input voltage: changed (24VDC is not applicable.) Rated input current: changed On voltage/on current: changed Off voltage/off current: changed Input resistance: not changed 5) Function: not changed
	A1SX40-S1	QX40-S1	1) External wiring: changed 2) Number of slots: not changed 3) Program Number of occupied I/O points: not changed 4) Specifications Rated input voltage: not changed Rated input current: changed On voltage/on current: changed Off voltage/off current: changed Input resistance: changed 5) Function: not changed
	A1SX40-S2	QX40	1) External wiring: changed 2) Number of slots: not changed 3) Program Number of occupied I/O points: not changed 4) Specifications Rated input voltage: not changed Rated input current: changed On voltage/on current: changed Off voltage/off current: changed Input resistance: changed 5) Function: not changed

AnS/QnAS series model		Q series alternative model	
Product	Model	Model	Remarks (restrictions)
Input module	A1SX41	QX41 (24VDC)	1) External wiring: not changed 2) Number of slots: not changed 3) Program Number of occupied I/O points: not changed 4) Specifications Rated input voltage: changed (12VDC is not applicable.) Rated input current: changed (Approx.7mA → Approx.4mA) On voltage/on current: changed Off voltage/off current: changed Input resistance: changed 5) Function: not changed
		QX41-S2 (24VDC)	1) External wiring: not changed 2) Number of slots: not changed 3) Program Number of occupied I/O points: not changed 4) Specifications Rated input voltage: changed (12VDC is not applicable.) Rated input current: changed (Approx.7mA → Approx.6mA) On voltage/on current: changed Off voltage/off current: changed Input resistance: changed 5) Function: not changed
		QX71 (12VDC)	1) External wiring: not changed 2) Number of slots: not changed 3) Program Number of occupied I/O points: not changed 4) Specifications Rated input voltage: changed (24VDC is not applicable.) Rated input current: changed On voltage/on current: changed Off voltage/off current: changed Input resistance: changed 5) Function: not changed
	A1SX41-S1	QX41-S1	1) External wiring: not changed 2) Number of slots: not changed 3) Program Number of occupied I/O points: not changed 4) Specifications Rated input voltage: not changed Rated input current: changed On voltage/on current: changed Off voltage/off current: changed Input resistance: changed 5) Function: not changed
	A1SX41-S2	QX41	1) External wiring: not changed 2) Number of slots: not changed 3) Program Number of occupied I/O points: not changed 4) Specifications Rated input voltage: not changed Rated input current: changed (Approx.7mA → Approx.4mA) On voltage/on current: changed Off voltage/off current: changed Input resistance: changed 5) Function: not changed
		QX41-S2	1) External wiring: not changed 2) Number of slots: not changed 3) Program Number of occupied I/O points: not changed 4) Specifications Rated input voltage: not changed Rated input current: changed (Approx.7mA → Approx.6mA) On voltage/on current: changed Off voltage/off current: changed Input resistance: changed 5) Function: not changed

AnS/QnAS series model		Q series alternative model	
Product	Model	Model	Remarks (restrictions)
Input module	A1SX42	QX42 (24VDC)	1) External wiring: not changed 2) Number of slots: not changed 3) Program Number of occupied I/O points: not changed 4) Specifications Rated input voltage: changed (12VDC is not applicable.) Rated input current: changed (Approx.5mA → Approx.4mA) On voltage/on current: changed Off voltage/off current: changed Input resistance: changed 5) Function: not changed
		QX41-S2 (24VDC)	1) External wiring: not changed 2) Number of slots: changed (2 modules are required.) 3) Program Number of occupied I/O points: not changed (64 points =32 points × 2 modules) 4) Specifications Rated input voltage: changed (12VDC is not applicable.) Rated input current: changed (Approx.5mA → Approx.6mA) On voltage/on current: changed Off voltage/off current: changed Input resistance: changed 5) Function: not changed
		QX72 (12VDC)	1) External wiring: not changed 2) Number of slots: not changed 3) Program Number of occupied I/O points: not changed 4) Specifications Rated input voltage: changed (24VDC is not applicable.) Rated input current: changed On voltage/on current: changed Off voltage/off current: changed Input resistance: changed 5) Function: not changed
	A1SX42-S1	QX42-S1	1) External wiring: not changed 2) Number of slots: not changed 3) Program Number of occupied I/O points: not changed 4) Specifications Rated input voltage: not changed Rated input current: changed On voltage/on current: changed Off voltage/off current: changed Input resistance: changed 5) Function: not changed
	A1SX42-S2	QX42	1) External wiring: not changed 2) Number of slots: not changed 3) Program Number of occupied I/O points: not changed 4) Specifications Rated input voltage: not changed Rated input current: changed (Approx.5mA → Approx.4mA) On voltage/on current: changed Off voltage/off current: changed Input resistance: changed 5) Function: not changed
		QX41-S2	1) External wiring: not changed 2) Number of slots: changed (2 modules are required.) 3) Program Number of occupied I/O points: not changed (64 points =32 points × 2 modules) 4) Specifications Rated input voltage: not changed Rated input current: changed (Approx.5mA → Approx.6mA) On voltage/on current: changed Off voltage/off current: changed Input resistance: changed 5) Function: not changed

AnS/QnAS series model		Q series alternative model	
Product	Model	Model	Remarks (restrictions)
Input module	A1SX71	QX41-S1*2 (24VDC, positive common)	1) External wiring: not changed 2) Number of slots: not changed 3) Program Number of occupied I/O points: not changed 4) Specifications Rated input voltage: changed (5VDC and 12VDC are not applicable.) Rated input current: changed On voltage/on current: changed Off voltage/off current: changed Input resistance: changed 5) Function: not changed
		QX41-S2 (24VDC)	1) External wiring: not changed 2) Number of slots: not changed 3) Program Number of occupied I/O points: not changed 4) Specifications Rated input voltage: changed (5VDC and 12VDC are not applicable.) Rated input current: changed On voltage/on current: changed Off voltage/off current: changed Input resistance: changed 5) Function: not changed
		QX71 (5VDC, 12VDC)	1) External wiring: not changed 2) Number of slots: not changed 3) Program Number of occupied I/O points: not changed 4) Specifications Rated input voltage: changed (24VDC is not applicable.) Rated input current: not changed On voltage/on current: not changed Off voltage/off current: not changed Input resistance: changed 5) Function: not changed
	A1SX80	QX80*3 (24VDC, negative common)	1) External wiring: changed 2) Number of slots: not changed 3) Program Number of occupied I/O points: not changed 4) Specifications Rated input voltage: changed (12VDC is not applicable.) Rated input current: changed On voltage/on current: changed Off voltage/off current: changed Input resistance: changed 5) Function: not changed
		QX70 (12VDC)	1) External wiring: changed 2) Number of slots: not changed 3) Program Number of occupied I/O points: not changed 4) Specifications Rated input voltage: changed (24VDC is not applicable.) Rated input current: changed On voltage/on current: changed Off voltage/off current: changed Input resistance: not changed 5) Function: not changed
	A1SX80-S1	QX80*4 (negative common)	1) External wiring: changed 2) Number of slots: not changed 3) Program Number of occupied I/O points: not changed 4) Specifications Rated input voltage: not changed Rated input current: changed On voltage/on current: changed Off voltage/off current: changed Input resistance: changed 5) Function: not changed

AnS/QnAS series model		Q series alternative model	
Product	Model	Model	Remarks (restrictions)
Input module	A1SX80-S2	QX80*4 (negative common)	1) External wiring: changed 2) Number of slots: not changed 3) Program Number of occupied I/O points: not changed 4) Specifications Rated input voltage: not changed Rated input current: changed On voltage/on current: changed Off voltage/off current: changed Input resistance: changed 5) Function: not changed
		QX81*5 (24VDC, negative common)	1) External wiring: not changed 2) Number of slots: not changed 3) Program Number of occupied I/O points: not changed 4) Specifications Rated input voltage: changed (12VDC is not applicable.) Rated input current: changed (Approx.7mA → Approx.4mA) On voltage/on current: changed Off voltage/off current: changed Input resistance: changed 5) Function: not changed
	A1SX81	QX81-S2*5 (24VDC, negative common)	1) External wiring: not changed 2) Number of slots: not changed 3) Program Number of occupied I/O points: not changed 4) Specifications Rated input voltage: changed (12VDC is not applicable.) Rated input current: changed (Approx.7mA → Approx.6mA) On voltage/on current: changed Off voltage/off current: changed Input resistance: changed 5) Function: not changed
		QX71 (12VDC)	1) External wiring: changed 2) Number of slots: not changed 3) Program Number of occupied I/O points: not changed 4) Specifications Rated input voltage: changed (24VDC is not applicable.) Rated input current: changed On voltage/on current: changed Off voltage/off current: changed Input resistance: not changed 5) Function: not changed
	A1SX81-S2	QX81*5 (negative common)	1) External wiring: not changed 2) Number of slots: not changed 3) Program Number of occupied I/O points: not changed 4) Specifications Rated input voltage: not changed Rated input current: changed (Approx.7mA → Approx.4mA) On voltage/on current: changed Off voltage/off current: changed Input resistance: changed 5) Function: not changed
		QX81-S2*5 (negative common)	1) External wiring: not changed 2) Number of slots: not changed 3) Program Number of occupied I/O points: not changed 4) Specifications Rated input voltage: not changed Rated input current: changed (Approx.7mA → Approx.6mA) On voltage/on current: changed Off voltage/off current: changed Input resistance: changed 5) Function: not changed

AnS/QnAS series model		Q series alternative model	
Product	Model	Model	Remarks (restrictions)
Input module	A1SX82-S1	QX82-S1 ^{*6} (negative common)	1) External wiring: not changed 2) Number of slots: not changed 3) Program Number of occupied I/O points: not changed 4) Specifications Rated input voltage: not changed Rated input current: changed On voltage/on current: changed Off voltage/off current: changed Input resistance: changed 5) Function: not changed
Output module	A1SY10 A1SY10EU	QY10	1) External wiring: changed 2) Number of slots: not changed 3) Program Number of occupied I/O points: not changed 4) Specifications Rated output voltage: not changed Rated output current: not changed (However, the contact life span of the A1SY10EU is reduced to half.) 5) Function: not changed
	A1SY14EU	QY10	1) External wiring: changed 2) Number of slots: not changed 3) Program Number of occupied I/O points: not changed 4) Specifications Rated output voltage: not changed Rated output current: not changed (However, contact life span is reduced to half.) 5) Function: not changed
	A1SY18A	QY18A	1) External wiring: changed 2) Number of slots: not changed 3) Program Number of occupied I/O points: not changed 4) Specifications Rated output voltage: not changed Rated output current: not changed (However, contact life span is reduced to half.) 5) Function: not changed
	A1SY18AEU	QY18A	1) External wiring: changed 2) Number of slots: not changed 3) Program Number of occupied I/O points: not changed 4) Specifications Rated output voltage: not changed Rated output current: not changed (However, contact life span is reduced to half.) 5) Function: not changed
	A1SY22	QY22	1) External wiring: changed 2) Number of slots: not changed 3) Program Number of occupied I/O points: not changed 4) Specifications Rated output voltage: not changed Rated output current: not changed 5) Function: changed (no fuse)
	A1SY28A	(None)	-
	A1SY28EU	(None)	-
	A1SY40	QY40P	1) External wiring: changed 2) Number of slots: not changed 3) Program Number of occupied I/O points: not changed 4) Specifications Rated output voltage: not changed Rated output current: not changed 5) Function: changed (fuse → overheat, overload protection)

AnS/QnAS series model		Q series alternative model	
Product	Model	Model	Remarks (restrictions)
Output module	A1SY40P	QY40P	1) External wiring: changed 2) Number of slots: not changed 3) Program Number of occupied I/O points: not changed 4) Specifications Rated output voltage: not changed Rated output current: not changed 5) Function: not changed
	A1SY41	QY41P	1) External wiring: not changed 2) Number of slots: not changed 3) Program Number of occupied I/O points: not changed 4) Specifications Rated output voltage: not changed Rated output current: not changed 5) Function: changed (fuse → overheat, overload protection)
	A1SY41P	QY41P	1) External wiring: not changed 2) Number of slots: not changed 3) Program Number of occupied I/O points: not changed 4) Specifications Rated output voltage: not changed Rated output current: not changed 5) Function: not changed
	A1SY42	QY42P	1) External wiring: not changed 2) Number of slots: not changed 3) Program Number of occupied I/O points: not changed 4) Specifications Rated output voltage: not changed Rated output current: not changed 5) Function: changed (fuse → overheat, overload protection)
	A1SY42P	QY42P	1) External wiring: not changed 2) Number of slots: not changed 3) Program Number of occupied I/O points: not changed 4) Specifications Rated output voltage: not changed Rated output current: not changed 5) Function: not changed
	A1SY50	QY50	1) External wiring: changed 2) Number of slots: not changed 3) Program Number of occupied I/O points: not changed 4) Specifications Rated output voltage: not changed Rated output current: not changed 5) Function: not changed
	A1SY60	QY68A	1) External wiring: changed 2) Number of slots: changed (2 modules are required.) 3) Program Number of occupied I/O points: changed (16 points → 32 points (16 points × 2 modules)) 4) Specifications Rated output voltage: not changed Rated output current: not changed 5) Function: changed (no fuse, independent common)
	A1SY60E	QY68A	1) External wiring: changed 2) Number of slots: changed (2 modules are required.) 3) Program Number of occupied I/O points: changed (16 points → 32 points (16 points × 2 modules)) 4) Specifications Rated output voltage: not changed Rated output current: not changed 5) Function: changed (no fuse, independent common)

AnS/QnAS series model		Q series alternative model	
Product	Model	Model	Remarks (restrictions)
Output module	A1SY68A	QY68A	1) External wiring: changed 2) Number of slots: not changed 3) Program Number of occupied I/O points: not changed 4) Specifications Rated output voltage: changed (48VDC is not applicable.) Rate output current: not changed 5) Function: not changed
	A1SY71	QY71	1) External wiring: not changed 2) Number of slots: not changed 3) Program Number of occupied I/O points: not changed 4) Specifications Rated output voltage: not changed Rated output current: not changed 5) Function: not changed
	A1SY80	QY80	1) External wiring: changed 2) Number of slots: not changed 3) Program Number of occupied I/O points: not changed 4) Specifications Rated output voltage: not changed Rated output current: changed 5) Function: not changed
	A1SY81	QY81P	1) External wiring: not changed 2) Number of slots: not changed 3) Program Number of occupied I/O points: not changed 4) Specifications Rated output voltage: not changed Rated output current: not changed 5) Function: changed (fuse → overheat, overload protection)
	A1SY81EP	QY81P	1) External wiring: not changed 2) Number of slots: not changed 3) Program Number of occupied I/O points: not changed 4) Specifications Rated output voltage: not changed Rated output current: not changed 5) Function: not changed
	A1SY82	QY82P	1) External wiring: not changed 2) Number of slots: not changed 3) Program Number of occupied I/O points: not changed 4) Specifications Rated output voltage: not changed Rated output current: not changed 5) Function: changed (fuse → overheat, overload protection)

AnS/QnAS series model		Q series alternative model	
Product	Model	Model	Remarks (restrictions)
I/O module	A1SH42	QH42P	1) External wiring: not changed 2) Number of slots: not changed 3) Program Number of occupied I/O points: not changed 4) Specifications (input part) Rated input voltage: changed (12VDC is not applicable.) Rated input current: changed On voltage/on current: changed Off voltage/off current: changed Input resistance: changed (output part) Rated output voltage: not changed Rated output current: not changed 5) Function: changed (fuse → overheat, overload protection)
	A1SH42P	QH42P	1) External wiring: not changed 2) Number of slots: not changed 3) Program Number of occupied I/O points: not changed 4) Specifications (input part) Rated input voltage: changed (12VDC is not applicable.) Rated input current: changed On voltage/on current: changed Off voltage/off current: changed Input resistance: changed (output part) Rated output voltage: not changed Rated output current: not changed 5) Function: not changed
	A1SH42-S1	QH42P	1) External wiring: not changed 2) Number of slots: not changed 3) Program Number of occupied I/O points: not changed 4) Specifications (input part) Rated input voltage: not changed Rated input current: changed On voltage/on current: changed Off voltage/off current: changed Input resistance: changed (output part) Rated output voltage: not changed Rated output current: not changed 5) Function: changed (fuse → overheat, overload protection)
	A1SH42P-S1	QH42P	1) External wiring: not changed 2) Number of slots: not changed 3) Program Number of occupied I/O points: not changed 4) Specifications (input part) Rated input voltage: not changed Rated input current: changed On voltage/on current: changed Off voltage/off current: changed Input resistance: changed (output part) Rated output voltage: not changed Rated output current: not changed 5) Function: not changed

AnS/QnAS series model		Q series alternative model	
Product	Model	Model	Remarks (restrictions)
I/O module	A1SX48Y18	QX40 + QY10	1) External wiring: changed 2) Number of slots: changed (2 modules are required.) 3) Program Number of occupied I/O points: changed (16 points → 32 points (16 points × 2 modules)) 4) Specifications (input part) Rated input voltage: not changed Rated input current: changed On voltage/on current: changed Off voltage/off current: changed Input resistance: changed (output part) Rated output voltage: not changed Rated output current: not changed 5) Function: not changed
	A1SX48Y58	QX48Y57	1) External wiring: changed 2) Number of slots: not changed 3) Program Number of occupied I/O points: not changed 4) Specifications (input part) Rated input voltage: not changed Rated input current: changed On voltage/on current: changed Off voltage/off current: changed Input resistance: changed (output part) Rated output voltage: not changed Rated output current: not changed 5) Function: changed (number of output points: 8 points → 7 points)
	A1SJ-56DT	QX40 + QY50	1) External wiring: changed 2) Number of slots: changed (5 slots → 4 slots) 3) Program Number of occupied I/O points: changed (128 points (including 4 empty slots) → 64 points (4 slots)) 4) Specifications (input part) Rated input voltage: not changed Rated input current: changed On voltage/on current: changed Off voltage/off current: changed Input resistance: changed (output part) Rated output voltage: not changed Rated output current: not changed 5) Function: changed (no fuse → built-in fuse)
	A1SJ-56DR	QX40 + QY10	1) External wiring: changed 2) Number of slots: changed (5 slots → 4 slots) 3) Program Number of occupied I/O points: changed (128 points (including 4 empty slots) → 64 points (4 slots)) 4) Specifications (input part) Rated input voltage: not changed Rated input current: changed On voltage/on current: changed Off voltage/off current: changed Input resistance: changed (output part) Rated output voltage: not changed Rated output current: not changed 5) Function: not changed
Dynamic scan I/O module	A1S42X	None	Consider converting input signals from dynamic to static and using the QX42.
	A1S42Y	None	Consider converting input signals from dynamic to static and using the QY42P.

AnS/QnAS series model		Q series alternative model	
Product	Model	Model	Remarks (restrictions)
Interrupt module	A1SI61	QI60	1) External wiring: changed 2) Number of slots: not changed 3) Program Number of occupied I/O points: changed (32 points → 16 points) 4) Specifications Rated input voltage: changed (12VDC is not applicable.) Rated input current: changed On voltage/on current: changed Off voltage/off current: changed Input resistance: changed 5) Function: changed (condition setting: hardware switch → parameter)
Dummy module	A1SG62	None	[Dummy module function] Consider using the QG60 and I/O assignment setting.
Blank cover	A1SG60	QG60	No restrictions

- *1 Replacing the module with the QX80 is recommended when 24VDC and negative common are used. Replacing the module with the QX70 is recommended when 12VDC is used.
- *2 Replacing the module with the QX81-S2 is recommended when 24VDC and negative common are used.
- *3 Replacing the module with the QX41-S1 is recommended when 24VDC and positive common are used.
- *4 Replacing the module with the QX40 is recommended when the positive common is used.
- *5 Replacing the module with the QX41-S2 is recommended when 24VDC and positive common are used.
- *6 Replacing the module with the QX42 is recommended when the positive common is used.

Point

When using the extension base unit of the A/QnA series, please refer to the following for details.
 Transition from MELSEC-A/QnA (Large Type) Series to Q Series Handbook (Fundamentals)
 L(NA)08043ENG

3.2 Comparison of I/O Module Specifications

3.2.1 Comparison of input module specifications

(1) Specifications comparison between A1SX10 and QX10

○: Compatible, △: Partially changed, ×: Incompatible

Specifications		A1SX10	QX10	Compat- ibility	Precautions for replacement
Number of input points		16 points	16 points	○	
Isolation method		Photocoupler	Photocoupler	○	
Rated input voltage		100-120VAC 50/60Hz	100-120VAC 50/60Hz	○	
Input voltage distortion		Within 5%	Within 5%	○	
Rated input current		Approx. 6mA (100VAC, 60Hz)	Approx. 8mA (100VAC, 60Hz) Approx. 7mA (100VAC, 50Hz)	○	The rated input current is increased.*1
Inrush current		Maximum 200mA Within 1ms (132VAC)	Maximum 200mA Within 1ms (132VAC)	○	
Operating voltage range		85 to 132VAC (50/60Hz±5%)	85 to 132VAC (50/60Hz±3Hz)	○	
Maximum number of simultaneous input points		Refer to the derating chart.*2	Refer to the derating chart.*2	△	Use it within the range shown in the derating chart.
On voltage/on current		80VAC or more/5mA or more	80VAC or more/5mA or more (50Hz, 60Hz)	○	
Off voltage/off current		30VAC or less/1.4mA or less	30VAC or less/1.7mA or less (50Hz, 60Hz)	△	The off current is increased.*1
Input resistance		Approx. 18kΩ (60Hz) Approx. 21kΩ (50Hz)	Approx. 12kΩ (60Hz) Approx. 15kΩ (50Hz)	○	The input resistance is reduced.*1
Response time	Off → on	20ms or less (100VAC, 60Hz)	15ms or less (100VAC 50Hz, 60Hz)	○	
	On → off	35ms or less (100VAC, 60Hz)	20ms or less (100VAC 50Hz, 60Hz)	○	
Common terminal arrangement		16 points/common (common terminal: TB9, TB18)	16 points/common (common terminal: TB17)	○	
Operation indication		On indication (LED)	On indication (LED)	○	
External connection system		20-point terminal block connector (M3.5×7 screws)	18-point terminal block (M3×6 screws)	×	Wiring change is required.
Applicable wire size		0.75 to 1.25mm ²	Core: 0.3 to 0.75mm ² (outside diameter: 2.8mm (0.11 inches) or less)	×	
Applicable solderless terminal		R1.25-3.5, R2-3.5, RAV1.25-3.5, RAV2-3.5	R1.25-3 (Sleeved solderless terminal cannot be used.)	×	
Current consumption		0.05A (typ. all points on)	0.05A (typ. all points on)	○	
External dimensions		130(H)×34.5(W)×93.6(D)mm	98(H)×27.4(W)×90(D)mm	△	Wiring space is narrower.
Weight		0.21kg	0.17kg	○	

*1 Check the specifications of the sensor or switches to be connected to the QX10.

*2 The following shows the derating chart.

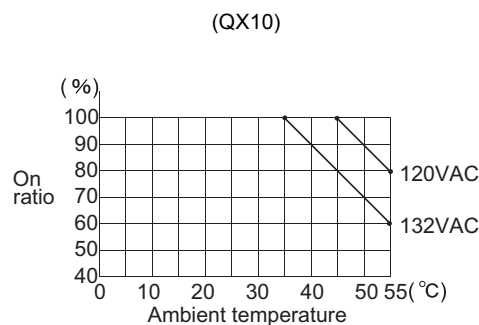
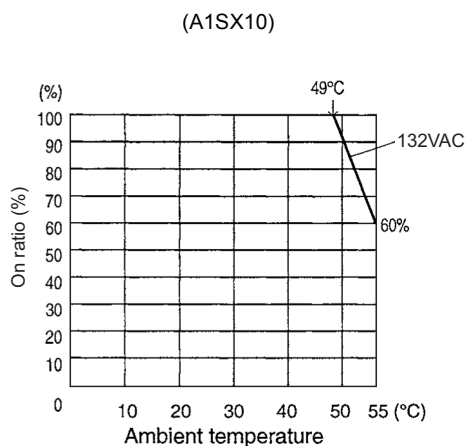

(2) Specifications comparison between A1SX10EU and QX10

○: Compatible, △: Partially changed, ×: Incompatible

Specifications		A1SX10EU	QX10	Compat- ibility	Precautions for replacement
Number of input points		16 points	16 points	○	
Isolation method		Photocoupler	Photocoupler	○	
Rated input voltage		100-120VAC 50/60Hz	100-120VAC 50/60Hz	○	
Input voltage distortion		Within 5%	Within 5%	○	
Rated input current		Approx. 7mA (120VAC 60Hz)	Approx. 8mA (100VAC, 60Hz), Approx. 7mA (100VAC, 50Hz)	○	The rated input current is increased.*1
Inrush current		Maximum 200mA Within 1ms (132VAC)	Maximum 200mA Within 1ms (132VAC)	○	
Operating voltage range		85 to 132VAC (50/60Hz±5%)	85 to 132VAC (50/60Hz±3Hz)	○	
Maximum number of simultaneous input points		Simultaneously on (100%)	Refer to the derating chart.*2	△	Use it within the range shown in the derating chart.
On voltage/on current		80VAC or more/5mA or more	80VAC or more/5mA or more (50Hz, 60Hz)	○	
Off voltage/off current		30VAC or less/1.4mA or less	30VAC or less/1.7mA or less (50Hz, 60Hz)	△	The off current is increased.*1
Input resistance		Approx. 18kΩ (60Hz) Approx. 21kΩ (50Hz)	Approx. 12kΩ (60Hz) Approx. 15kΩ (50Hz)	○	The input resistance is reduced.*1
Response time	Off → on	20ms or less (100VAC 60Hz)	15ms or less (100VAC 50Hz, 60Hz)	○	
	On → off	35ms or less (100VAC 60Hz)	20ms or less (100VAC 50Hz, 60Hz)	○	
Common terminal arrangement		16 points/common (common terminal: TB9, TB18)	16 points/common (common terminal: TB17)	○	
Operation indication		On indication (LED)	On indication (LED)	○	
External connection system		20-point terminal block connector (M3.5×7 screws)	18-point terminal block (M3×6 screws)	×	Wiring change is required.
Applicable wire size		0.75 to 1.25mm ² (16 to 19 AWG)	Core: 0.3 to 0.75mm ² (outside diameter: 2.8mm (0.11 inches) or less)	×	
Applicable solderless terminal		RAV1.25-3.5	R1.25-3 (Sleeved solderless terminal cannot be used.)	×	
Current consumption		0.05A (typ. all points on)	0.05A (typ. all points on)	○	
Dielectric withstand voltage (between batch external circuits and internal circuit)		1780VAC rms/3 cycles (altitude 2,000m (6562ft))	1780VAC rms/3 cycles (altitude 2000m (6562ft))	○	
Insulation resistance		10MΩ or more with an insulation resistance tester	10MΩ or more with an insulation resistance tester	○	
Noise immunity		IEC801-4: 1kV	<ul style="list-style-type: none"> By noise simulator of 1500Vp-p noise voltage, 1μs noise width, and 25 to 60Hz noise frequency First transient noise IEC61000-4-4: 1kV 	○	
External dimensions		130(H)×34.5(W)×93.6(D)mm	98(H)×27.4(W)×90(D)mm	△	Wiring space is narrower.
Weight		0.21kg	0.17kg	○	

*1 Check the specifications of the sensor or switches to connected to the QX10.

*2 The following shows the derating chart.

(QX10)

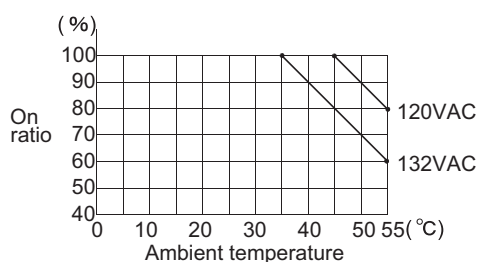

(3) Specifications comparison between A1SX20 and QX28

○: Compatible, △: Partially changed, ×: Incompatible

Specifications	A1SX20	QX28	Compatibility	Precautions for replacement
Number of input points	16 points	8 points (16 points occupied)	△	When 9 or more points are used, use two QX28 modules.
Isolation method	Photocoupler	Photocoupler	○	
Rated input voltage	200-240VAC 50/60Hz	100-240VAC 50/60Hz	○	
Input voltage distortion	Within 5%	Within 5%	○	
Rated input current	Approx. 9mA (200VAC 60Hz)	Approx. 17mA (200VAC, 60Hz), Approx. 14mA (200VAC, 50Hz), Approx. 8mA (100VAC, 60Hz), Approx. 7mA (100VAC, 50Hz)	○	The rated input current is increased.*1
Inrush current	Maximum 500mA Within 1ms (264VAC)	Maximum 500mA Within 1ms (264VAC)	○	
Operating voltage range	170 to 264VAC (50/60Hz±5%)	85 to 264VAC (50/60Hz±3Hz)	○	
Maximum number of simultaneous input points	Refer to the derating chart.*2	Refer to the derating chart.*2	○	Use it within the range shown in the derating chart.
On voltage/on current	80VAC or more/4mA or more	80VAC or more/5mA or more (50Hz, 60Hz)	△	The on current is increased.*1
Off voltage/off current	30VAC or less/1mA or less	30VAC or less/1.7mA or less (50Hz, 60Hz)	△	The off current is increased.*1
Input resistance	Approx. 22kΩ(60Hz), Approx. 27kΩ(50Hz)	Approx. 12kΩ(60Hz), Approx. 15kΩ(50Hz)	○	The input resistance is reduced.*1
Response time	Off → on	30ms or less (200VAC, 60Hz)	○	
	On → off	55ms or less (200VAC, 60Hz)	○	
Common terminal arrangement	16 points/common (common terminal: TB9, TB18)	8 points/common (common terminal: TB17)	○	
Operation indication	On indication (LED)	On indication (LED)	○	
External connection system	20-point terminal block connector (M3.5×7 screws)	18-point terminal block (M3×6 screws)	×	Wiring change is required.
Applicable wire size	0.75 to 1.25mm ²	Core: 0.3 to 0.75mm ² (outside diameter: 2.8mm (0.11 inches) or less)	×	
Applicable solderless terminal	R1.25-3.5, R2-3.5, RAV1.25-3.5, RAV2-3.5	R1.25-3 (Sleeved solderless terminal cannot be used.)	×	
Current consumption	0.05A (typ. all points on)	0.05A (typ. all points on)	△	When two QX28 modules are used, the current consumption is increased. Review the current capacity.
External dimensions	130(H)×34.5(W)×93.6(D)mm	98(H)×27.4(W)×90(D)mm	△	Wiring space is narrower.
Weight	0.23kg	0.20kg	△	When two QX28 modules are used, the weight is increased. Calculate the weight carefully.

*1 Check the specifications of the sensor or switches to be connected to the QX28.

*2 The following shows the derating chart.

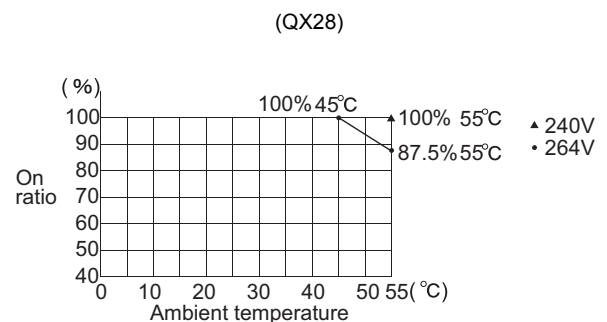
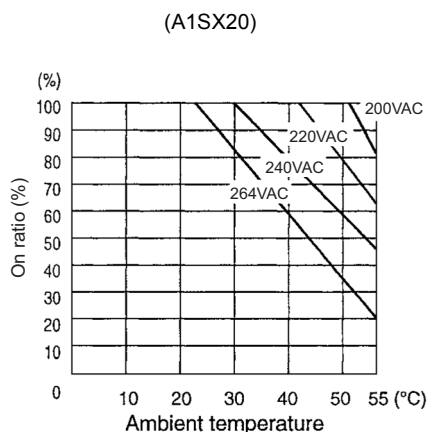

(4) Specifications comparison between A1SX20EU and QX28

○: Compatible, △: Partially changed, ×: Incompatible

Specifications	A1SX20EU	QX28	Compat- ibility	Precautions for replacement
Number of input points	16 points	8 points (16 points occupied)	△	When 9 or more points are used, use two QX28 modules.
Isolation method	Photocoupler	Photocoupler	○	
Rated input voltage	200-240VAC 50/60Hz	100-240VAC 50/60Hz	○	
Input voltage distortion	Within 5%	Within 5%	○	
Rated input current	Approx. 11mA (240VAC 60Hz)	Approx. 17mA (200VAC, 60Hz), Approx. 14mA (200VAC, 50Hz), Approx. 8mA (100VAC, 60Hz), Approx. 7mA (100VAC, 50Hz)	○	
Inrush current	Maximum 500mA Within 1ms (264VAC)	Maximum 500mA Within 1ms (264VAC)	○	
Operating voltage range	170 to 264VAC (50/60Hz±5%)	85 to 264VAC (50/60Hz±3Hz)	○	
Maximum number of simultaneous input points	Refer to the derating chart.*2	Refer to the derating chart.*2	○	
On voltage/on current	80VAC or more/4mA or more	80VAC or more/5mA or more (50Hz, 60Hz)	△	The on current is increased.*1
Off voltage/off current	30VAC or less/1mA or less	30VAC or less/1.7mA or less (50Hz, 60Hz)	△	The off current is increased.*1
Input resistance	Approx. 22kΩ (60Hz), Approx. 27kΩ (50Hz)	Approx. 12kΩ (60Hz), Approx. 15kΩ (50Hz)	○	The input resistance is reduced.*1
Response time	Off → on	30ms or less (200VAC 60Hz)	○	
	On → off	55ms or less (200VAC 60Hz)	○	
Common terminal arrangement	16 points/common (common terminal: TB9, TB18)	8 points/common (common terminal: TB17)	○	
Operation indication	On indication (LED)	On indication (LED)	○	
External connection system	20-point terminal block connector (M3.5×7 screws)	18-point terminal block (M3×6 screws)	×	Wiring change is required.
Applicable wire size	0.75 to 1.25mm ² (16 to 19 AWG)	Core: 0.3 to 0.75mm ² (outside diameter: 2.8mm (0.11 inches) or less)	×	
Applicable solderless terminal	RAV1.25-3.5	R1.25-3 (Sleeved solderless terminal cannot be used.)	×	
Dielectric withstand voltage	2830VAC rms/3 cycles (altitude 2,000m (6562ft.))	2830VAC rms/3 cycles (altitude 2,000m (6562ft.))	○	
Insulation resistance	10MΩ or more with an insulation resistance tester	10MΩ or more with an insulation resistance tester	○	
Current consumption	0.05A (typ. all points on)	0.05A (typ. all points on)	△	When two QX28 modules are used, the current consumption is increased. Review the current capacity.
External dimensions	130(H)×34.5(W)×93.6(D)mm	98(H)×27.4(W)×90(D)mm	△	Wiring space is narrower.
Weight	0.23kg	0.20kg	△	When two QX28 modules are used, the weight is increased. Calculate the weight carefully.

*1 Check the specifications of the sensor or switches to be connected to the QX28.

*2 The following shows the derating chart.

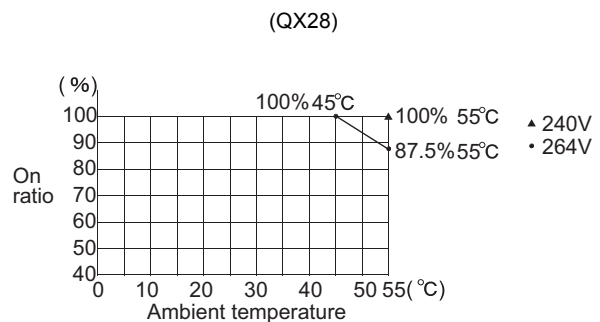
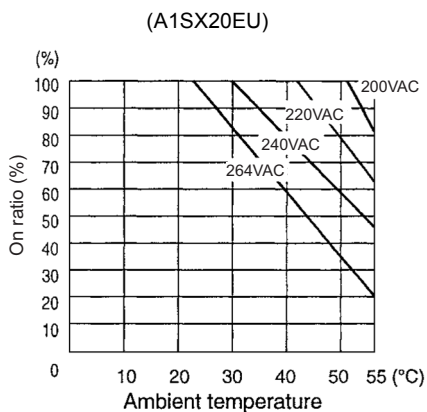

(5) Specifications comparison between A1SX30 and QX40

○: Compatible, △: Partially changed, ×: Incompatible

Specifications		A1SX30	QX40	Compat- ibility	Precautions for replacement
Number of input points		16 points	16 points	○	
Isolation method		Photocoupler	Photocoupler	○	
Rated input voltage		12/24VDC, 12/24VAC (50/60Hz)	24VDC	△	12/24VAC and 12VDC are not applicable.*1
Rated input current		8.5mA (24VDC/AC), 4mA (12VDC/AC)	Approx. 4mA	△	The rated input current is reduced.*2
Operating voltage range		10.2 to 26.4VDC (ripple ratio within 5%), 10.2 to 26.4VAC (50/60Hz±5%)	20.4 to 28.8VDC (ripple ratio within 5%)	△	12/24VAC and 12VDC are not applicable.*1
Maximum number of simultaneous input points		Refer to the derating chart.*3	Simultaneously on (100%)	○	
On voltage/on current		7VDC/AC or more/2mA or more	19VDC or more/3mA or more	△	12/24VAC and 12VDC are not applicable.*1*2
Off voltage/off current		2.7VDC/AC or less/0.7mA or less	11VDC or less/1.7mA or less	△	12/24VAC and 12VDC are not applicable.*1*2
Input resistance		Approx. 2.7kΩ	Approx. 5.6kΩ	△	The input resistance is increased.*2
Response time	Off → on	20ms or less (12/24VDC), 25ms or less (12/24VAC 60Hz)	1ms/5ms/10ms/20ms/70ms or less (Configure the setting in the PLC parameter dialog box.) 10ms is set by default.	○	Set the input response time of the parameter to 20ms.
	On → off	20ms or less (12/24VDC), 20ms or less (12/24VAC 60Hz)	1ms/5ms/10ms/20ms/70ms or less (Configure the setting in the PLC parameter dialog box.) 10ms is set by default.	○	
Common terminal arrangement		16 points/common (common terminal: TB9, TB18)	16 points/common (common terminal: TB17)	○	
Operation indication		On indication (LED)	On indication (LED)	○	
External connection system		20-point terminal block connector (M3.5×7 screws)	18-point terminal block (M3×6 screws)	×	Wiring change is required.
Applicable wire size		0.75 to 1.25mm ²	Core: 0.3 to 0.75mm ² (outside diameter: 2.8mm (0.11 inches) or less)	×	
Applicable solderless terminal		R1.25-3.5, R2-3.5, RAV1.25-3.5, RAV2-3.5	R1.25-3 (Sleeved solderless terminal cannot be used.)	×	
Current consumption		0.05A (typ. all points on)	0.05A (typ. all points on)	○	
External dimensions		130(H)×34.5(W)×93.6(D)mm	98(H)×27.4(W)×90(D)mm	△	Wiring space is narrower.
Weight		0.20kg	0.16kg	○	

*1 For use of 12/24VAC, externally convert it into DC before input.

When applying 12VDC, use the QX70.

*2 Check the specifications of the sensor or switches to be connected to the QX40.

*3 The following shows the derating chart.

(A1SX30)

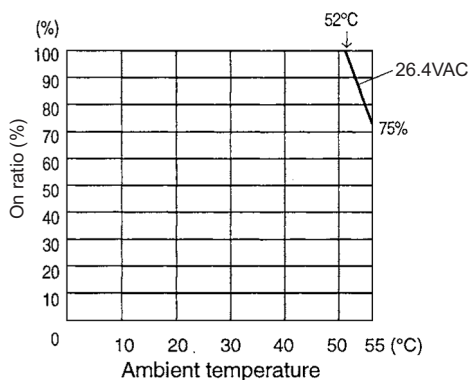

(6) Specifications comparison between A1SX40 and QX40

○: Compatible, △: Partially changed, ×: Incompatible

Specifications		A1SX40	QX40	Compat- ibility	Precautions for replacement
Number of input points		16 points	16 points	○	
Isolation method		Photocoupler	Photocoupler	○	
Rated input voltage		12/24VDC	24VDC	△	12VDC is not applicable.*1
Rated input current		Approx. 3mA/Approx. 7mA	Approx. 4mA	△	The rated input current is reduced.*2
Operating voltage range		10.2 to 26.4VDC (ripple ratio within 5%)	20.4 to 28.8VDC (ripple ratio within 5%)	△	12VDC is not applicable.*1
Maximum number of simultaneous input points		Simultaneously on (100%) (26.4VDC)	Simultaneously on (100%)	○	
On voltage/on current		8VDC or more/2mA or more	19VDC or more/3mA or more	△	12VDC is not applicable.*1*2
Off voltage/off current		4VDC or less/1mA or less	11VDC or less/1.7mA or less	△	12VDC is not applicable.*1*2
Input resistance		Approx. 3.3kΩ	Approx. 5.6kΩ	△	The input resistance is increased.*2
Response time	Off → on	10ms or less (24VDC)	1ms/5ms/10ms/20ms/70ms or less (Configure the setting in the PLC parameter dialog box.) 10ms is set by default.	○	Set the input response time of parameter to the default value (10ms).
	On → off	10ms or less (24VDC)	1ms/5ms/10ms/20ms/70ms or less (Configure the setting in the PLC parameter dialog box.) 10ms is set by default.	○	
Common terminal arrangement		16 points/common (common terminal: TB9, TB18)	16 points/common (common terminal: TB17)	○	
Operation indication		On indication (LED)	On indication (LED)	○	
External connection system		20-point terminal block connector (M3.5×7 screws)	18-point terminal block (M3×6 screws)	×	Wiring change is required.
Applicable wire size		0.75 to 1.25mm ²	Core: 0.3 to 0.75mm ² (outside diameter: 2.8mm (0.11 inches) or less)	×	
Applicable solderless terminal		R1.25-3.5, R2-3.5, RAV1.25-3.5, RAV2-3.5	R1.25-3 (Sleeved solderless terminal cannot be used.)	×	
Current consumption		0.05A (typ. all points on)	0.05A (typ. all points on)	○	
External dimensions		130(H)×34.5(W)×93.6(D)mm	98(H)×27.4(W)×90(D)mm	△	Wiring space is narrower.
Weight		0.20kg	0.16kg	○	

*1 When applying 12VDC, use the QX70.

*2 Check the specifications of the sensor or switches to be connected to the QX40.

(7) Specifications comparison between A1SX40 and QX70

○: Compatible, △: Partially changed, ×: Incompatible

Specifications		A1SX40	QX70	Compatibility	Precautions for replacement
Number of input points		16 points	16 points	○	
Isolation method		Photocoupler	Photocoupler	○	
Rated input voltage		12/24VDC	5/12VDC	△	24VDC is not applicable.*1
Rated input current		Approx. 3mA/Approx. 7mA	5VDC Approx. 1.2mA 12VDC Approx. 3.3mA	△	24VDC is not applicable.**2
Operating voltage range		10.2 to 26.4VDC (ripple ratio within 5%)	4.5 to 6VDC (ripple ratio within 5%) 10.2 to 14.4VDC (ripple ratio within 5%)	△	24VDC is not applicable.*1
Maximum number of simultaneous input points		Simultaneously on (100%) (26.4VDC)	Simultaneously on (100%)	○	
On voltage/on current		8VDC or more/2mA or more	3.5VDC or more/1mA or more	△	24VDC is not applicable.**2
Off voltage/off current		4VDC or less/1mA or less	1VDC or less/0.1mA or less	△	24VDC is not applicable.**2
Input resistance		Approx. 3.3kΩ	Approx. 3.3kΩ	○	
Response time	Off → on	10ms or less (24VDC)	1ms/5ms/10ms/20ms/70ms or less (Configure the setting in the PLC parameter dialog box.) 10ms is set by default.	○	Set the input response time of parameter to the default value (10ms).
	On → off	10ms or less (24VDC)	1ms/5ms/10ms/20ms/70ms or less (Configure the setting in the PLC parameter dialog box.) 10ms is set by default.	○	
Common terminal arrangement		16 points/common (common terminal: TB9, TB18)	16 points/common (common terminal: TB17)	○	
Operation indication		On indication (LED)	On indication (LED)	○	
External connection system		20-point terminal block connector (M3.5×7 screws)	18-point terminal block (M3×6 screws)	×	Wiring change is required.
Applicable wire size		0.75 to 1.25mm ²	Core: 0.3 to 0.75mm ² (outside diameter: 2.8mm (0.11 inches) or less)	×	
Applicable solderless terminal		R1.25-3.5, R2-3.5, RAV1.25-3.5, RAV2-3.5	R1.25-3 (Sleeved solderless terminal cannot be used.)	×	
Current consumption		0.05A (typ. all points on)	0.055A (typ. all points on)	○	
External dimensions		130(H)×34.5(W)×93.6(D)mm	98(H)×27.4(W)×90(D)mm	△	Wiring space is narrower.
Weight		0.20kg	0.14kg	○	

*1 When applying 24VDC, use the QX40.

*2 Check the specifications of the sensor or switches to be connected to the QX70.

(8) Specifications comparison between A1SX40-S1 and QX40-S1

○ : Compatible, △ : Partially changed, × : Incompatible

Specifications		A1SX40-S1	QX40-S1	Compat- ibility	Precautions for replacement
Number of input points		16 points	16 points	○	
Isolation method		Photocoupler	Photocoupler	○	
Rated input voltage		24VDC	24VDC	○	
Rated input current		Approx. 7mA	Approx. 6mA	△	The rated input current is reduced.*1
Operating voltage range		19.2 to 26.4VDC (ripple ratio within 5%)	20.4 to 28.8VDC (ripple ratio within 5%)	△	The operating voltage range differs.
Maximum number of simultaneous input points		Simultaneously on (100%) (26.4VDC)	Simultaneously on (100%)	○	
On voltage/on current		14VDC or more/4.0mA or more	19VDC or more/4.0mA or more	△	The on voltage differs.*1
Off voltage/off current		6.5VDC or less/1.7mA or less	11VDC or less/1.7mA or less	△	The off voltage differs.*1
Input resistance		Approx. 3.3kΩ	Approx. 3.9kΩ	△	The input resistance is increased.*1
Response time	Off → on	0.1ms or less (24VDC)	0.1ms/0.2ms/0.4ms/0.6ms/1ms or less (Configure the setting in the PLC parameter dialog box.) 0.2ms is set by default.	○	Set the input response time of parameter to 0.1ms.
	On → off	0.2ms or less (24VDC)	0.1ms/0.2ms/0.4ms/0.6ms/1ms or less (Configure the setting in the PLC parameter dialog box.) 0.2ms is set by default.	○	
Common terminal arrangement		16 points/common (common terminal: TB9, TB18)	16 points/common (common terminal: TB17)	○	
Operation indication		On indication (LED)	On indication (LED)	○	
External connection system		20-point terminal block connector (M3.5×7 screws)	18-point terminal block (M3×6 screws)	×	Wiring change is required.
Applicable wire size		0.75 to 1.25mm ²	Core: 0.3 to 0.75mm ² (outside diameter: 2.8mm (0.11 inches) or less)	×	
Applicable solderless terminal		R1.25-3.5, R2-3.5, RAV1.25-3.5, RAV2-3.5	R1.25-3 (Sleeved solderless terminal cannot be used.)	×	
Current consumption		0.05A (typ. all points on)	0.06A (typ. all points on)	△	The current consumption is increased.
External dimensions		130(H)×34.5(W)×93.6(D)mm	98(H)×27.4(W)×90(D)mm	△	Wiring space is narrower.
Weight		0.20kg	0.20kg	○	

*1 Check the specifications of the sensor or switches to be connected to the QX40-S1.

(9) Specifications comparison between A1SX40-S2 and QX40

○: Compatible, △: Partially changed, ×: Incompatible

Specifications		A1SX40-S2	QX40	Compat- ibility	Precautions for replacement
Number of input points		16 points	16 points	○	
Isolation method		Photocoupler	Photocoupler	○	
Rated input voltage		24VDC	24VDC	○	
Rated input current		Approx. 7mA	Approx. 4mA	△	The rated input current is reduced.*1
Operating voltage range		19.2 to 26.4VDC (ripple ratio within 5%)	20.4 to 28.8VDC (ripple ratio within 5%)	△	The operating voltage range differs.
Maximum number of simultaneous input points		Simultaneously on (100%) (26.4VDC)	Simultaneously on (100%)	○	
On voltage/on current		14VDC or more/3.5mA or more	19VDC or more/3mA or more	△	The on voltage/on current differ.*1
Off voltage/off current		6.5VDC or less/1.7mA or less	11VDC or less/1.7mA or less	△	The off voltage differs.*1
Input resistance		Approx. 3.3kΩ	Approx. 5.6kΩ	△	The input resistance is increased.*1
Response time	Off → on	10ms or less (24VDC)	1ms/5ms/10ms/20ms/70ms or less (Configure the setting in the PLC parameter dialog box.) 10ms is set by default.	○	Set the input response time of parameter to the default value (10ms).
	On → off	10ms or less (24VDC)	1ms/5ms/10ms/20ms/70ms or less (Configure the setting in the PLC parameter dialog box.) 10ms is set by default.	○	
Common terminal arrangement		16 points/common (common terminal: TB9, TB18)	16 points/common (common terminal: TB17)	○	
Operation indication		On indication (LED)	On indication (LED)	○	
External connection system		20-point terminal block connector (M3.5×7 screws)	18-point terminal block (M3×6 screws)	×	Wiring change is required.
Applicable wire size		0.75 to 1.25mm ²	Core: 0.3 to 0.75mm ² (outside diameter: 2.8mm (0.11 inches) or less)	×	
Applicable solderless terminal		R1.25-3.5, R2-3.5, RAV1.25-3.5, RAV2-3.5	R1.25-3 (Sleeved solderless terminal cannot be used.)	×	
Current consumption		0.05A (typ. all points on)	0.05A (typ. all points on)	○	
External dimensions		130(H)×34.5(W)×93.6(D)mm	98(H)×27.4(W)×90(D)mm	△	Wiring space is narrower.
Weight		0.20kg	0.16kg	○	

*1 Check the specifications of the sensor or switches to be connected to the QX40.

(10) Specifications comparison between A1SX41 and QX41

○: Compatible, △: Partially changed, ×: Incompatible

Specifications		A1SX41	QX41	Compat- ibility	Precautions for replacement
Number of input points		32 points	32 points	○	
Isolation method		Photocoupler	Photocoupler	○	
Rated input voltage		12/24VDC	24VDC	△	12VDC is not applicable. ^{*1}
Rated input current		Approx. 3mA/Approx. 7mA	Approx. 4mA	△	The rated input current is reduced. ^{*2}
Operating voltage range		10.2 to 26.4VDC (ripple ratio within 5%)	20.4 to 28.8VDC (ripple ratio within 5%)	△	12VDC is not applicable. ^{*1}
Maximum number of simultaneous input points		Refer to the derating chart. ^{*3}	Refer to the derating chart. ^{*3}	○	
On voltage/on current		8VDC or more/2mA or more	19VDC or more/3mA or more	△	12VDC is not applicable. ^{*1,2}
Off voltage/off current		4VDC or less/1mA or less	11VDC or less/1.7mA or less	△	12VDC is not applicable. ^{*1,2}
Input resistance		Approx. 3.3kΩ	Approx. 5.6kΩ	△	The input resistance is increased. ^{*2}
Response time	Off → on	10ms or less (24VDC)	1ms/5ms/10ms/20ms/70ms or less (Configure the setting in the PLC parameter dialog box.) 10ms is set by default.	○	Set the input response time of parameter to the default value (10ms).
	On → off	10ms or less (24VDC)	1ms/5ms/10ms/20ms/70ms or less (Configure the setting in the PLC parameter dialog box.) 10ms is set by default.	○	
Common terminal arrangement		32 points/common (common terminal: B1, B2)	32 points/common (common terminal: B01, B02)	○	
Operation indication		On indication (LED)	On indication (LED)	○	
External connection system		40-pin connector (accessory)	40-pin connector (sold separately)	○	Existing external wiring can be used.
Applicable wire size		0.3mm ²	0.3mm ² (A6CON1, A6CON4)	○	
Current consumption		0.08A (typ. all points on)	0.075A (typ. all points on)	○	
External dimensions		130(H)×34.5(W)×93.6(D)mm	98(H)×27.4(W)×90(D)mm	○	
Weight		0.21kg	0.15kg	○	

*1 When applying 12VDC, use the QX71.

*2 Check the specifications of the sensor or switches to be connected to the QX41.

*3 The following shows the derating chart.

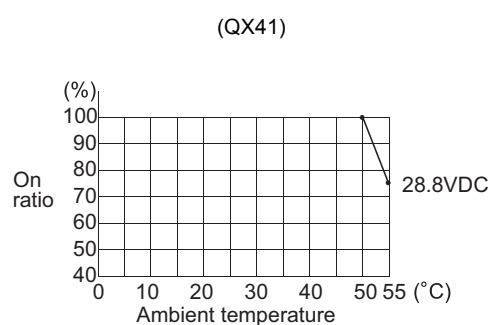
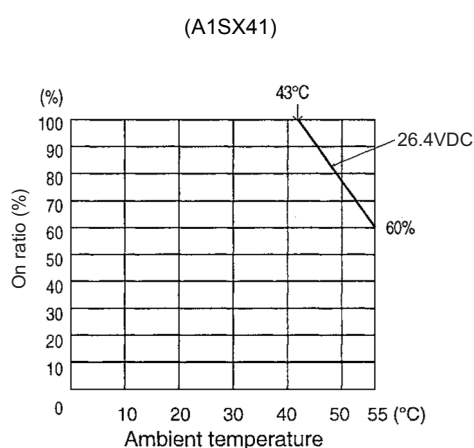

(11) Specifications comparison between A1SX41 and QX41-S2

○: Compatible, △: Partially changed, ×: Incompatible

Specifications		A1SX41	QX41-S2	Compatibility	Precautions for replacement
Number of input points		32 points	32 points	○	
Isolation method		Photocoupler	Photocoupler	○	
Rated input voltage		12/24VDC	24VDC	△	12VDC is not applicable.*1
Rated input current		Approx. 3mA/Approx. 7mA	Approx. 6mA	△	The rated input current is reduced.*2
Operating voltage range		10.2 to 26.4VDC (ripple ratio within 5%)	20.4 to 28.8VDC (ripple ratio within 5%)	△	12VDC is not applicable.*1
Maximum number of simultaneous input points		Refer to the derating chart.*3	Refer to the derating chart.*3	△	Use it within the range shown in the derating chart.
On voltage/on current		8VDC or more/2mA or more	15VDC or more/3mA or more	△	12VDC is not applicable.*1*2
Off voltage/off current		4VDC or less/1mA or less	5VDC or less/1.7mA or less	△	12VDC is not applicable.*1*2
Input resistance		Approx. 3.3kΩ	Approx. 3.6kΩ	△	The input resistance is increased.*2
Response time	Off → on	10ms or less (24VDC)	1ms/5ms/10ms/20ms/70ms or less (Configure the setting in the PLC parameter dialog box.) 10ms is set by default.	○	Set the input response time of parameter to the default value (10ms).
	On → off	10ms or less (24VDC)	1ms/5ms/10ms/20ms/70ms or less (Configure the setting in the PLC parameter dialog box.) 10ms is set by default.	○	
Common terminal arrangement		32 points/common (common terminal: B1, B2)	32 points/common (common terminal: B01, B02)	○	
Operation indication		On indication (LED)	On indication (LED)	○	
External connection system		40-pin connector (accessory)	40-pin connector (sold separately)	○	Existing external wiring can be used.
Applicable wire size		0.3mm ²	0.3mm ² (A6CON1, A6CON4)	○	
Current consumption		0.08A (typ. all points on)	0.075A (typ. all points on)	○	
External dimensions		130(H)×34.5(W)×93.6(D)mm	98(H)×27.4(W)×90(D)mm	○	
Weight		0.21kg	0.15kg	○	

*1 When applying 12VDC, use the QX71.

*2 Check the specifications of the sensor or switches to be connected to the QX41-S2.

*3 The following shows the derating chart.

(A1SX41)

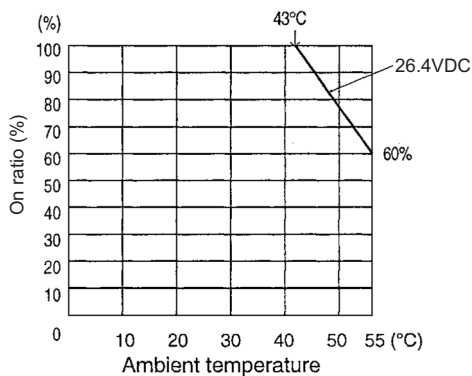

(QX41-S2)

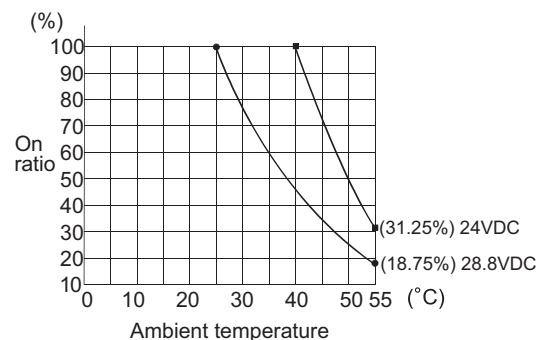

(12) Specifications comparison between A1SX41 and QX71

○ : Compatible, △ : Partially changed, × : Incompatible

Specifications		A1SX41	QX71	Compat- ibility	Precautions for replacement
Number of input points		32 points	32 points	○	
Isolation method		Photocoupler	Photocoupler	○	
Rated input voltage		12/24VDC	5/12VDC	△	24VDC is not applicable.*1
Rated input current		Approx. 3mA/Approx. 7mA	5VDC Approx.1.2mA 12VDC Approx.3.3mA	△	The rated input current is reduced.*1*2
Operating voltage range		10.2 to 26.4VDC (ripple ratio within 5%)	4.5 to 6VDC (ripple ratio within 5%) 10.2 to 14.4VDC (ripple ratio within 5%)	△	24VDC is not applicable.*1
Maximum number of simultaneous input points		Refer to the derating chart.*3	Simultaneously on (100%)	○	
On voltage/on current		8VDC or more/2mA or more	3.5VDC or more/1mA or more	△	24VDC is not applicable.*1*2
Off voltage/off current		4VDC or less/1mA or less	1VDC or less/0.1mA or less	△	24VDC is not applicable.*1*2
Input resistance		Approx. 3.3kΩ	Approx. 3.3kΩ	○	
Response time	Off → on	10ms or less (24VDC)	1ms/5ms/10ms/20ms/70ms or less (Configure the setting in the PLC parameter dialog box.) 10ms is set by default.	○	Set the input response time of parameter to the default value (10ms).
	On → off	10ms or less (24VDC)	1ms/5ms/10ms/20ms/70ms or less (Configure the setting in the PLC parameter dialog box.) 10ms is set by default.	○	
Common terminal arrangement		32 points/common (common terminal: B1, B2)	32 points/common (common terminal: B01, B02)	○	
Operation indication		On indication (LED)	On indication (LED)	○	
External connection system		40-pin connector (accessory)	40-pin connector (sold separately)	○	Existing external wiring can be used.
Applicable wire size		0.3mm ²	0.3mm ² (A6CON1, A6CON4)	○	
Current consumption		0.08A (typ. all points on)	0.075A (typ. all points on)	○	
External dimensions		130(H)×34.5(W)×93.6(D)mm	98(H)×27.4(W)×90(D)mm	○	
Weight		0.21kg	0.12kg	○	

*1 When applying 24VDC, use the QX41(-S2).

*2 Check the specifications of the sensor or switches to be connected to the QX71.

*3 The following shows the derating chart.

(A1SX41)

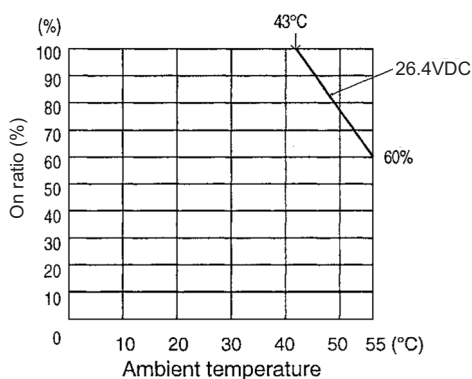

(13) Specifications comparison between A1SX41-S1 and QX41-S1

○: Compatible, △: Partially changed, ×: Incompatible

Specifications		A1SX41-S1	QX41-S1	Compat- ibility	Precautions for replacement
Number of input points		32 points	32 points	○	
Isolation method		Photocoupler	Photocoupler	○	
Rated input voltage		24VDC	24VDC	○	
Rated input current		Approx. 7mA	Approx. 4mA	△	The rated input current is reduced.*1
Operating voltage range		19.2 to 26.4VDC (ripple ratio within 5%)	20.4 to 28.8VDC (ripple ratio within 5%)	△	The operating voltage range differs.
Maximum number of simultaneous input points		Refer to the derating chart.*2	Refer to the derating chart.*2	○	
On voltage/on current		17VDC or more/4.5mA or more	19VDC or more/3mA or more	△	The on voltage/on current differ.*1
Off voltage/off current		3.5VDC or less/0.8mA or less	9.5VDC or less/1.5mA or less	△	The off voltage/off current differ.*1
Input resistance		Approx. 3.3kΩ	Approx. 5.6kΩ	△	The input resistance is increased.*1
Response time	Off → on	0.3ms or less (24VDC)	0.1ms/0.2ms/0.4ms/0.6ms/1ms or less (Configure the setting in the PLC parameter dialog box.) 0.2ms is set by default.	○	The response time differs. Set the time according to the control.
	On → off	0.3ms or less (24VDC)	0.1ms/0.2ms/0.4ms/0.6ms/1ms or less (Configure the setting in the PLC parameter dialog box.) 0.2ms is set by default.	○	
Common terminal arrangement		32 points/common (common terminal: B1, B2)	32 points/common (common terminal: B01, B02)	○	
Operation indication		On indication (LED)	On indication (LED)	○	
External connection system		40-pin connector (accessory)	40-pin connector (sold separately)	○	Existing external wiring can be used.
Applicable wire size		0.3mm ²	0.3mm ² (A6CON1, A6CON4)	○	
Current consumption		0.12A (typ. all points on)	0.075A (typ. all points on)	○	
External dimensions		130(H)×34.5(W)×93.6(D)mm	98(H)×27.4(W)×90(D)mm	○	
Weight		0.21kg	0.15kg	○	

*1 Check the specifications of the sensor or switches to be connected to the QX41-S1.

*2 The following shows the derating chart.

(A1SX41-S1)

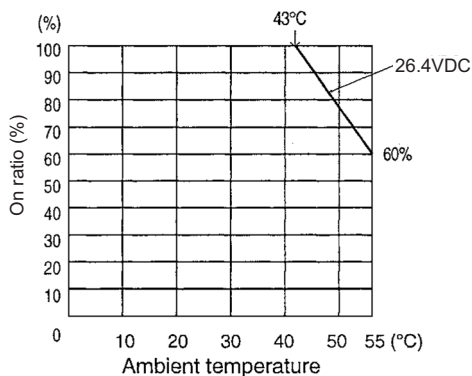

(QX41-S1)

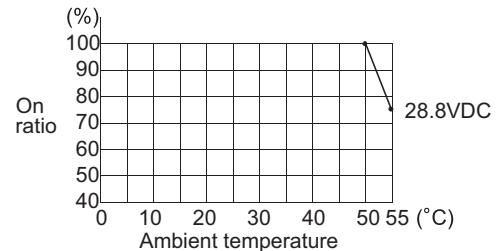

(14) Specifications comparison between A1SX41-S2 and QX41

○: Compatible, △: Partially changed, ×: Incompatible

Specifications		A1SX41-S2	QX41	Compat- ibility	Precautions for replacement
Number of input points		32 points	32 points	○	
Isolation method		Photocoupler	Photocoupler	○	
Rated input voltage		24VDC	24VDC	○	
Rated input current		Approx. 7mA	Approx. 4mA	△	The rated input current is reduced.*1
Operating voltage range		19.2 to 26.4VDC (ripple ratio within 5%)	20.4 to 28.8VDC (ripple ratio within 5%)	△	The operating voltage range differs.
Maximum number of simultaneous input points		Refer to the derating chart.*2	Refer to the derating chart.*2	○	
On voltage/on current		14VDC or more/3.5mA or more	19VDC or more/3mA or more	△	The on voltage /on current differ.*1
Off voltage/off current		6.5VDC or less/1.7mA or less	11VDC or less/1.7mA or less	△	The off voltage differs.*1
Input resistance		Approx. 3.3kΩ	Approx. 5.6kΩ	△	The input resistance is increased.*1
Response time	Off → on	10ms or less (24VDC)	1ms/5ms/10ms/20ms/70ms or less (Configure the setting in the PLC parameter dialog box.) 10ms is set by default.	○	Set the input response time of parameter to the default value (10ms).
	On → off	10ms or less (24VDC)	1ms/5ms/10ms/20ms/70ms or less (Configure the setting in the PLC parameter dialog box.) 10ms is set by default.	○	
Common terminal arrangement		32 points/common (common terminal: B1, B2)	32 points/common (common terminal: B01, B02)	○	
Operation indication		On indication (LED)	On indication (LED)	○	
External connection system		40-pin connector (accessory)	40-pin connector (sold separately)	○	Existing external wiring can be used.
Applicable wire size		0.3mm ²	0.3mm ² (A6CON1, A6CON4)	○	
Current consumption		0.08A (typ. all points on)	0.075A (typ. all points on)	○	
External dimensions		130(H)×34.5(W)×93.6(D)mm	98(H)×27.4(W)×90(D)mm	○	
Weight		0.21kg	0.15kg	○	

*1 Check the specifications of the sensor or switches to be connected to the QX41.

*2 The following shows the derating chart.

(A1SX41-S2)

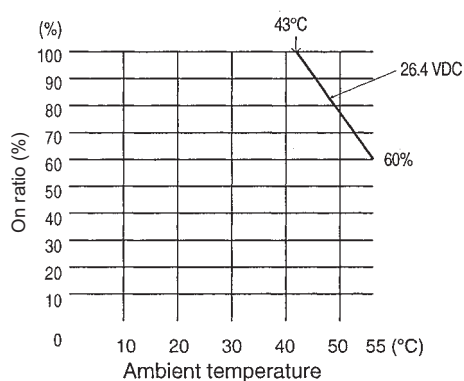

(QX41)

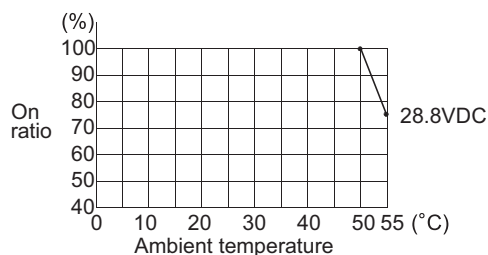

(15) Specifications comparison between A1SX41-S2 and QX41-S2

○: Compatible, △: Partially changed, ×: Incompatible

Specifications		A1SX41-S2	QX41-S2	Compatibility	Precautions for replacement
Number of input points		32 points	32 points	○	
Isolation method		Photocoupler	Photocoupler	○	
Rated input voltage		24VDC	24VDC	○	
Rated input current		Approx. 7mA	Approx. 6mA	△	The rated input current is reduced.*1
Operating voltage range		19.2 to 26.4VDC (ripple ratio within 5%)	20.4 to 28.8VDC (ripple ratio within 5%)	△	The operating voltage range differs.
Maximum number of simultaneous input points		Refer to the derating chart.*2	Refer to the derating chart.*2	△	Use it within the range shown in the derating chart.
On voltage/on current		14VDC or more/3.5mA or more	15VDC or more/3mA or more	△	The on voltage /on current differ.*1
Off voltage/off current		6.5VDC or less/1.7mA or less	5VDC or less/1.7mA or less	△	The off voltage differs.*1
Input resistance		Approx. 3.3kΩ	Approx. 3.6kΩ	△	The input resistance is increased.*1
Response time	Off → on	10ms or less (24VDC)	1ms/5ms/10ms/20ms/70ms or less (Configure the setting in the PLC parameter dialog box.) 10ms is set by default.	○	Set the input response time of parameter to the default value (10ms).
	On → off	10ms or less (24VDC)	1ms/5ms/10ms/20ms/70ms or less (Configure the setting in the PLC parameter dialog box.) 10ms is set by default.	○	
Common terminal arrangement		32 points/common (common terminal: B1, B2)	32 points/common (common terminal: B01, B02)	○	
Operation indication		On indication (LED)	On indication (LED)	○	
External connection system		40-pin connector (accessory)	40-pin connector (sold separately)	○	Existing external wiring can be used.
Applicable wire size		0.3mm ²	0.3mm ² (A6CON1, A6CON4)	○	
Current consumption		0.08A (typ. all points on)	0.075A (typ. all points on)	○	
External dimensions		130(H)×34.5(W)×93.6(D)mm	98(H)×27.4(W)×90(D)mm	○	
Weight		0.21kg	0.15kg	○	

*1 Check the specifications of the sensor or switches to be connected to the QX41-S2.

*2 The following shows the derating chart.

(A1SX41-S2)

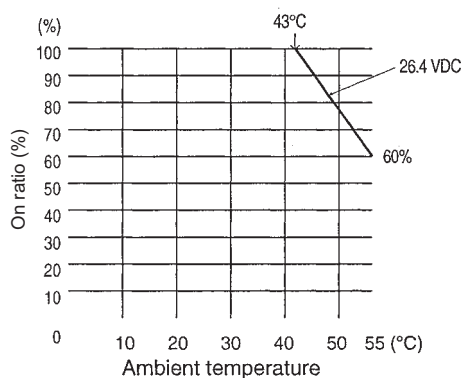

(QX41-S2)

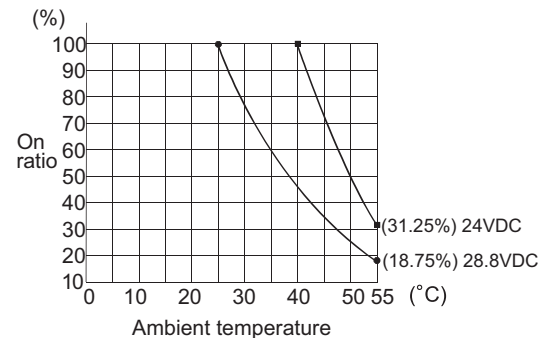

(16) Specifications comparison between A1SX42 and QX42

○ : Compatible, △ : Partially changed, × : Incompatible

Specifications		A1SX42	QX42	Compat- ibility	Precautions for replacement
Number of input points		64 points	64 points	○	
Isolation method		Photocoupler	Photocoupler	○	
Rated input voltage		12/24VDC	24VDC	△	12VDC is not applicable.*1
Rated input current		Approx. 2mA/Approx. 5mA	Approx. 4mA	△	The rated input current is reduced.*2
Operating voltage range		10.2 to 26.4VDC (ripple ratio within 5%)	20.4 to 28.8VDC (ripple ratio within 5%)	△	12VDC is not applicable.*1
Maximum number of simultaneous input points		Refer to the derating chart.*3	Refer to the derating chart.*3	○	
On voltage/on current		8VDC or more/2mA or more	19VDC or more/3mA or more	△	12VDC is not applicable.*1*2
Off voltage/off current		4VDC or less/0.6mA or less	11VDC or less/1.7mA or less	△	12VDC is not applicable.*1*2
Input resistance		Approx. 5kΩ	Approx. 5.6kΩ	△	The input resistance is increased.*2
Response time	Off → on	10ms or less (24VDC)	1ms/5ms/10ms/20ms/70ms or less (Configure the setting in the PLC parameter dialog box.) 10ms is set by default.	○	Set the input response time of parameter to the default value (10ms).
	On → off	10ms or less (24VDC)	1ms/5ms/10ms/20ms/70ms or less (Configure the setting in the PLC parameter dialog box.) 10ms is set by default.	○	
Common terminal arrangement		32 points/common (common terminal: 1B1, 1B2, 2B1, 2B2)	32 points/common (common terminal: 1B01, 1B02, 2B01, 2B02)	○	
Operation indication		On indication (LED) 32-point switching indication with the switch	On indication (LED) 32-point switching indication with the switch	○	
External connection system		40-pin connector 2 pieces (accessory)	40-pin connector 2 pieces (sold separately)	○	Existing external wiring can be used.
Applicable wire size		0.3mm ²	0.3mm ² (A6CON1, A6CON4)	○	
Current consumption		0.09A (typ. all points on)	0.09A (typ. all points on)	○	
External dimensions		130(H)×34.5(W)×93.6(D)mm	98(H)×27.4(W)×90(D)mm	○	
Weight		0.28kg	0.18kg	○	

*1 When applying 12VDC, use the QX72.

*2 Check the specifications of the sensor or switches to be connected to the QX42.

*3 The following shows the derating chart.

(A1SX42)

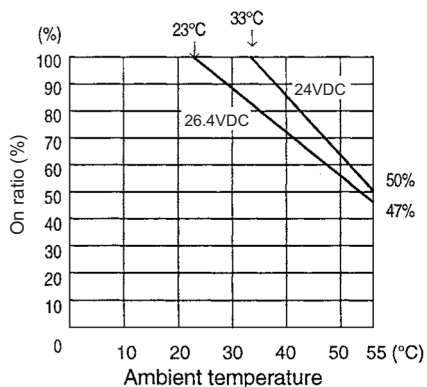

(QX42)

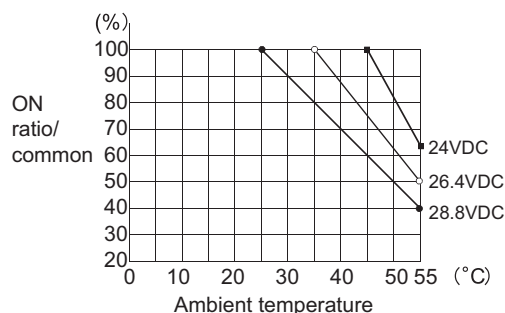

(17) Specifications comparison between A1SX42 and QX41-S2

○: Compatible, △: Partially changed, ×: Incompatible

Specifications		A1SX42	QX41-S2	Compatibility	Precautions for replacement
Number of input points		64 points	32 points	△	When 33 or more points are used, use two QX41-S2 modules.
Isolation method		Photocoupler	Photocoupler	○	
Rated input voltage		12/24VDC	24VDC	△	12VDC is not applicable.*1
Rated input current		Approx. 2mA/Approx. 5mA	Approx. 6mA	○	
Operating voltage range		10.2 to 26.4VDC (ripple ratio within 5%)	20.4 to 28.8VDC (ripple ratio within 5%)	△	12VDC is not applicable.*1
Maximum number of simultaneous input points		Refer to the derating chart.*3	Refer to the derating chart.*3	△	Use it within the range shown in the derating chart.
On voltage/on current		8VDC or more/2mA or more	15VDC or more/3mA or more	△	12VDC is not applicable.*1*2
Off voltage/off current		4VDC or less/0.6mA or less	5VDC or less/1.7mA or less	△	12VDC is not applicable.*1*2
Input resistance		Approx. 5kΩ	Approx. 3.6kΩ	○	The input resistance is increased.*2
Response time	Off → on	10ms or less (24VDC)	1ms/5ms/10ms/20ms/70ms or less (Configure the setting in the PLC parameter dialog box.) 10ms is set by default.	○	Set the input response time of parameter to the default value (10ms).
	On → off	10ms or less (24VDC)	1ms/5ms/10ms/20ms/70ms or less (Configure the setting in the PLC parameter dialog box.) 10ms is set by default.	○	
Common terminal arrangement		32 points/common (common terminal: 1B1, 1B2, 2B1, 2B2)	32 points/common (common terminal: B01, B02)	○	
Operation indication		On indication (LED) 32-point switching indication with the switch	On indication (LED)	○	
External connection system		40-pin connector 2 pieces (accessory)	40-pin connector 2 pieces (sold separately)	○	Existing external wiring can be used.
Applicable wire size		0.3mm ²	0.3mm ² (A6CON1, A6CON4)	○	
Current consumption		0.09A (typ. all points on)	0.075A (typ. all points on)	○	
External dimensions		130(H)×34.5(W)×93.6(D)mm	98(H)×27.4(W)×90(D)mm	○	
Weight		0.28kg	0.15kg	○	

*1 When applying 12VDC, use the QX72.

*2 Check the specifications of the sensor or switches to be connected to the QX41-S2.

*3 The following shows the derating chart.

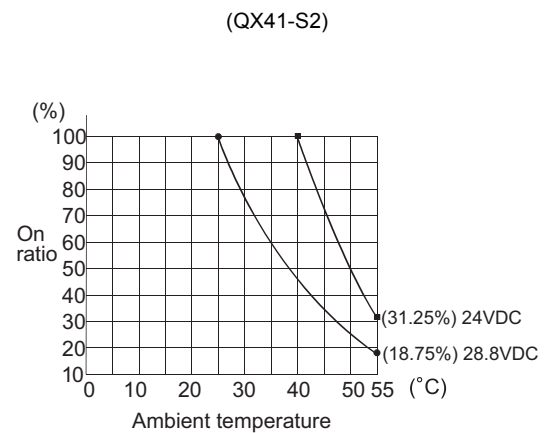
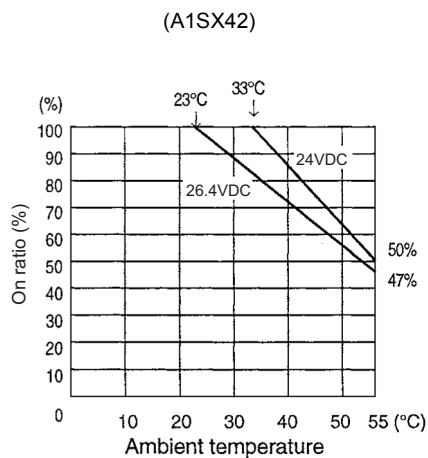

(18) Specifications comparison between A1SX42 and QX72

○ : Compatible, △ : Partially changed, × : Incompatible

Specifications		A1SX42	QX72	Compat- ibility	Precautions for replacement
Number of input points		64 points	64 points	○	
Isolation method		Photocoupler	Photocoupler	○	
Rated input voltage		12/24VDC	5/12VDC	△	24VDC is not applicable.*1
Rated input current		Approx. 2mA/Approx. 5mA	5VDC Approx. 1.2mA 12VDC Approx. 3.3mA	△	24VDC is not applicable.*1*2
Operating voltage range		10.2 to 26.4VDC (ripple ratio within 5%)	4.5 to 6VDC (ripple ratio within 5%) 10.2 to 14.4VDC (ripple ratio within 5%)	△	24VDC is not applicable.*1
Maximum number of simultaneous input points		Refer to the derating chart.*3	Simultaneously on (100%)	○	
On voltage/on current		8VDC or more/2mA or more	3.5VDC or more/1mA or more	△	24VDC is not applicable.*2
Off voltage/off current		4VDC or less/0.6mA or less	1VDC or less/0.1mA or less	△	24VDC is not applicable.*2
Input resistance		Approx. 5kΩ	Approx. 3.3kΩ	○	The input resistance is decreased.*2
Response time	Off → on	10ms or less (24VDC)	1ms/5ms/10ms/20ms/70ms or less (Configure the setting in the PLC parameter dialog box.) 10ms is set by default.	○	Set the input response time of parameter to the default value (10ms).
	On → off	10ms or less (24VDC)	1ms/5ms/10ms/20ms/70ms or less (Configure the setting in the PLC parameter dialog box.) 10ms is set by default.	○	
Common terminal arrangement		32 points/common (common terminal: 1B1, 1B2, 2B1, 2B2)	32 points/common (common terminal: 1B01, 1B02, 2B01, 2B02)	○	
Operation indication		On indication (LED) 32-point switching indication with the switch	On indication (LED) 32-point switching indication with the switch	○	
External connection system		40-pin connector 2 pieces (accessory)	40-pin connector 2 pieces (sold separately)	○	Existing external wiring can be used.
Applicable wire size		0.3mm ²	0.3mm ² (A6CON1, A6CON4)	○	
Current consumption		0.09A (typ. all points on)	0.085A (typ. all points on)	○	
External dimensions		130(H)×34.5(W)×93.6(D)mm	98(H)×27.4(W)×90(D)mm	○	
Weight		0.28kg	0.13kg	○	

*1 When applying 24VDC, use the QX42 or QX41-S2.

*2 Check the specifications of the sensor or switches to be connected to the QX72.

*3 The following shows the derating chart.

(A1SX42)

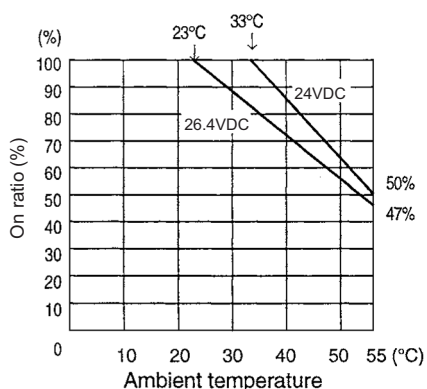

(19) Specifications comparison between A1SX42-S1 and QX42-S1

○: Compatible, △: Partially changed, ×: Incompatible

Specifications		A1SX42-S1	QX42-S1	Compatibility	Precautions for replacement
Number of input points		64 points	64 points	○	
Isolation method		Photocoupler	Photocoupler	○	
Rated input voltage		24VDC	24VDC	○	
Rated input current		Approx. 5mA	Approx. 4mA	△	The rated input current is reduced.*1
Operating voltage range		19.2 to 26.4VDC (ripple ratio within 5%)	20.4 to 28.8VDC (ripple ratio within 5%)	△	The operating voltage range differs.
Maximum number of simultaneous input points		Refer to the derating chart.*2	Refer to the derating chart.*2	○	
On voltage/on current		18.5VDC or more/3.5mA or more	19VDC or more/3mA or more	△	The on voltage/on current differ.*1
Off voltage/off current		3VDC or less/0.45mA or less	9.5VDC or less/1.5mA or less	△	The off voltage/off current differ.*1
Input resistance		Approx. 4.7kΩ	Approx. 5.6kΩ	△	The input resistance is increased.*1
Response time	Off → on	0.3ms or less (24VDC)	0.1ms/0.2ms/0.4ms/0.6ms/1ms or less (Configure the setting in the PLC parameter dialog box.) 0.2ms is set by default.	○	The response time differs. Set the time according to the control.
	On → off	0.3ms or less (24VDC)	0.1ms/0.2ms/0.4ms/0.6ms/1ms or less (Configure the setting in the PLC parameter dialog box.) 0.2ms is set by default.	○	
Common terminal arrangement		32 points/common (common terminal: 1B1, 1B2, 2B1, 2B2)	32 points/common (common terminal: 1B01, 1B02, 2B01, 2B02)	○	
Operation indication		On indication (LED) 32-point switching indication with the switch	On indication (LED) 32-point switching indication with the switch	○	
External connection system		40-pin connector 2 pieces (accessory)	40-pin connector 2 pieces (sold separately)	○	Existing external wiring can be used.
Applicable wire size		0.3mm ²	0.3mm ² (A6CON1, A6CON4)	○	
Current consumption		0.16A (typ. all points on)	0.09A (typ. all points on)	○	
External dimensions		130(H)×34.5(W)×93.6(D)mm	98(H)×27.4(W)×90(D)mm	○	
Weight		0.28kg	0.18kg	○	

*1 Check the specifications of the sensor or switches to be connected to the QX42-S1.

*2 The following shows the derating chart.

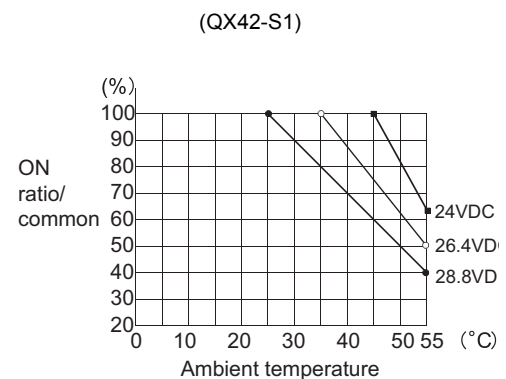
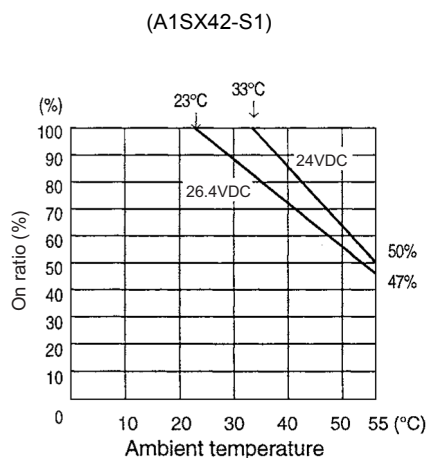

(20) Specifications comparison between A1SX42-S2 and QX42

○: Compatible, △: Partially changed, ×: Incompatible

Specifications		A1SX42-S2	QX42	Compat- ibility	Precautions for replacement
Number of input points		64 points	64 points	○	
Isolation method		Photocoupler	Photocoupler	○	
Rated input voltage		24VDC	24VDC	○	
Rated input current		Approx. 5mA	Approx. 4mA	△	The rated input current is reduced.*1
Operating voltage range		19.2 to 26.4VDC (ripple ratio within 5%)	20.4 to 28.8VDC (ripple ratio within 5%)	△	The operating voltage range differs.
Maximum number of simultaneous input points		Refer to the derating chart.*2	Refer to the derating chart.*2	○	
On voltage/on current		17.5VDC or more/3.5mA or more	19VDC or more/3mA or more	△	The on voltage/on current differ.*1
Off voltage/off current		7VDC or less/1.7mA or less	11VDC or less/1.7mA or less	△	The off voltage differs.*1
Input resistance		Approx. 4.7kΩ	Approx. 5.6kΩ	△	The input resistance is increased.*1
Response time	Off → on	10ms or less (24VDC)	1ms/5ms/10ms/20ms/70ms or less (Configure the setting in the PLC parameter dialog box.) 10ms is set by default.	○	Set the input response time of parameter to the default value (10ms).
	On → off	10ms or less (24VDC)	1ms/5ms/10ms/20ms/70ms or less (Configure the setting in the PLC parameter dialog box.) 10ms is set by default.	○	
Common terminal arrangement		32 points/common (common terminal: 1B1, 1B2, 2B1, 2B2)	32 points/common (common terminal: 1B01, 1B02, 2B01, 2B02)	○	
Operation indication		On indication (LED) 32-point switching indication with the switch	On indication (LED) 32-point switching indication with the switch	○	
External connection system		40-pin connector 2 pieces (accessory)	40-pin connector 2 pieces (sold separately)	○	Existing external wiring can be used.
Applicable wire size		0.3mm ²	0.3mm ² (A6CON1, A6CON4)	○	
Current consumption		0.09A (typ. all points on)	0.09A (typ. all points on)	○	
External dimensions		130(H)×34.5(W)×93.6(D)mm	98(H)×27.4(W)×90(D)mm	○	
Weight		0.28kg	0.18kg	○	

*1 Check the specifications of the sensor or switches to be connected to the QX42.

*2 The following shows the derating chart.

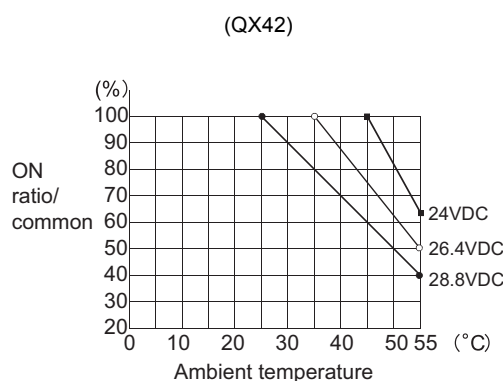
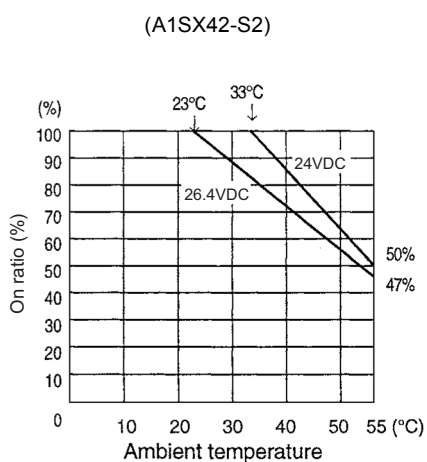

(21) Specifications comparison between A1SX42-S2 and QX41-S2

○: Compatible, △: Partially changed, ×: Incompatible

Specifications		A1SX42-S2	QX41-S2	Compatibility	Precautions for replacement
Number of input points		64 points	32 points	△	When 33 or more points are used, use two QX41-S2 modules.
Isolation method		Photocoupler	Photocoupler	○	
Rated input voltage		24VDC	24VDC	○	
Rated input current		Approx. 5mA	Approx. 6mA	○	
Operating voltage range		19.2 to 26.4VDC (ripple ratio within 5%)	20.4 to 28.8VDC (ripple ratio within 5%)	△	The operating voltage range differs.
Maximum number of simultaneous input points		Refer to the derating chart.*2	Refer to the derating chart.*2	△	Use it within the range shown in the derating chart.
On voltage/on current		17.5VDC or more/3.5mA or more	15VDC or more/3mA or more	△	The on voltage/on current differs.*1
Off voltage/off current		7VDC or less/1.7mA or less	5VDC or less/1.7mA or less	△	The off voltage differs.*1
Input resistance		Approx. 4.7kΩ	Approx. 3.6kΩ	○	The input resistance is reduced.*1
Response time	Off → on	10ms or less (24VDC)	1ms/5ms/10ms/20ms/70ms or less (Configure the setting in the PLC parameter dialog box.) 10ms is set by default.	○	Set the input response time of parameter to the default value (10ms).
	On → off	10ms or less (24VDC)	1ms/5ms/10ms/20ms/70ms or less (Configure the setting in the PLC parameter dialog box.) 10ms is set by default.	○	
Common terminal arrangement		32 points/common (common terminal: 1B1, 1B2, 2B1, 2B2)	32 points/common (common terminal: B01, B02)	○	
Operation indication		On indication (LED) 32-point switching indication with the switch	On indication (LED) 32-point switching indication with the switch	○	
External connection system		40-pin connector 2 pieces (accessory)	40-pin connector 2 pieces (sold separately)	○	Existing external wiring can be used.
Applicable wire size		0.3mm ²	0.3mm ² (A6CON1, A6CON4)	○	
Current consumption		0.09A (typ. all points on)	0.075A (typ. all points on)	○	
External dimensions		130(H)×34.5(W)×93.6(D)mm	98(H)×27.4(W)×90(D)mm	○	
Weight		0.28kg	0.15kg	○	

*1 Check the specifications of the sensor or switches to be connected to the QX41-S2.

*2 The following shows the derating chart.

(A1SX42-S2)

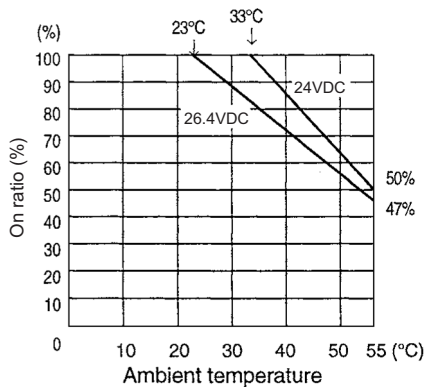

(QX41-S2)

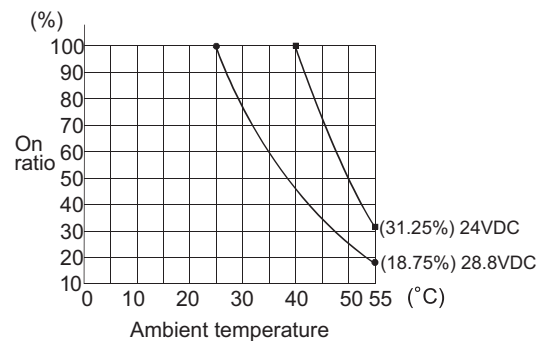

(22) Specifications comparison between A1SX71 and QX41-S1

○: Compatible, △: Partially changed, ×: Incompatible

Specifications		A1SX71	QX41-S1	Compat- ibility	Precautions for replacement
Number of input points		32 points	32 points	○	
Isolation method		Photocoupler	Photocoupler	○	
Rated input voltage		5/12/24VDC	24VDC	△	5/12VDC is not applicable.*1
Rated input current		5VDC Approx. 1.2mA 12VDC Approx. 3.3mA 24VDC Approx. 7mA	Approx. 4mA	△	The rated input current is reduced.*2
Operating voltage range		4.5 to 26.4VDC (ripple ratio within 5%)	20.4 to 28.8VDC (ripple ratio within 5%)	△	5/12VDC is not applicable.*1
Maximum number of simultaneous input points		Refer to the derating chart.*3	Refer to the derating chart.*3	○	
On voltage/on current		3.5VDC or more/1mA or more	19VDC or more/3mA or more	△	5/12VDC is not applicable.*1*2
Off voltage/off current		1VDC or less/0.1mA or less	9.5VDC or less/1.5mA or less	△	5/12VDC is not applicable.*1*2
Input resistance		Approx. 3.5kΩ	Approx. 5.6kΩ	△	The input resistance is increased.*2
Response time	Off → on	1.5ms or less	0.1ms/0.2ms/0.4ms/0.6ms/1ms or less (Configure the setting in the PLC parameter dialog box.) 0.2ms is set by default.	○	The response time differs. Set the time according to the control.
	On → off	3ms or less	0.1ms/0.2ms/0.4ms/0.6ms/1ms or less (Configure the setting in the PLC parameter dialog box.) 0.2ms is set by default.	○	
Common terminal arrangement		32 points/common (common terminal: B1, B2)	32 points/common (common terminal: B01, B02)	○	
Operation indication		On indication (LED)	On indication (LED)	○	
External connection system		40-pin connector (accessory)	40-pin connector (sold separately)	○	Existing external wiring can be used.
Applicable wire size		0.3mm ²	0.3mm ² (A6CON1, A6CON4)	○	
Current consumption		0.075A (typ. all points on)	0.075A (typ. all points on)	○	
External dimensions		130(H)×34.5(W)×93.6(D)mm	98(H)×27.4(W)×90(D)mm	○	
Weight		0.19kg	0.15kg	○	

*1 When applying 5/12VDC, use the QX71.

*2 Check the specifications of the sensor or switches to be connected to the QX41-S1.

*3 The following shows the derating chart.

(A1SX71)

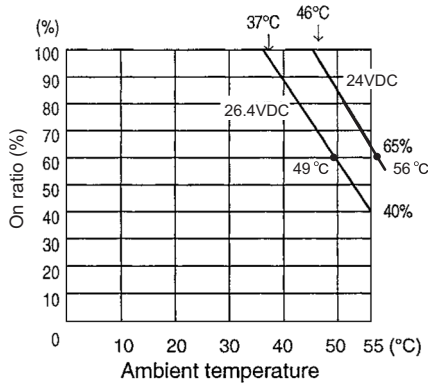

(QX41-S1)

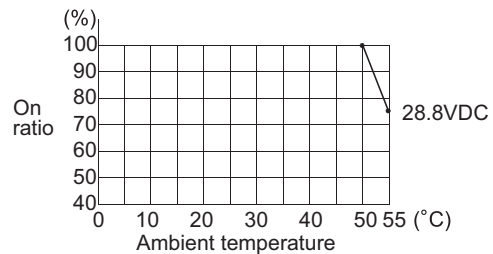

(23) Specifications comparison between A1SX71 and QX41-S2

○: Compatible, △: Partially changed, ×: Incompatible

Specifications		A1SX71	QX41-S2	Compatibility	Precautions for replacement
Number of input points		32 points	32 points	○	
Isolation method		Photocoupler	Photocoupler	○	
Rated input voltage		5/12/24VDC	24VDC	△	5/12VDC is not applicable.*1
Rated input current		5VDC Approx. 1.2mA 12VDC Approx. 3.3mA 24VDC Approx. 7mA	Approx. 6mA	△	The rated input current is reduced.*2
Operating voltage range		4.5 to 26.4VDC (ripple ratio within 5%)	20.4 to 28.8VDC (ripple ratio within 5%)	△	5/12VDC is not applicable.*1
Maximum number of simultaneous input points		Refer to the derating chart.*3	Refer to the derating chart.*3	△	Use it within the range shown in the derating chart.
On voltage/on current		3.5VDC or more/1mA or more	15VDC or more/3mA or more	△	5/12VDC is not applicable.*1*2
Off voltage/off current		1VDC or less/0.1mA or less	5VDC or less/1.7mA or less	△	5/12VDC is not applicable.*1*2
Input resistance		Approx. 3.5kΩ	Approx. 3.6kΩ	△	The input resistance is increased.*2
Response time	Off → on	1.5ms or less	1ms/5ms/10ms/20ms/70ms or less (Configure the setting in the PLC parameter dialog box.) 10ms is set by default.	○	The response time differs. Set the time according to the control.
	On → off	3ms or less	1ms/5ms/10ms/20ms/70ms or less (Configure the setting in the PLC parameter dialog box.) 10ms is set by default.	○	
Common terminal arrangement		32 points/common (common terminal: B1, B2)	32 points/common (common terminal: B01, B02)	○	
Operation indication		On indication (LED)	On indication (LED)	○	
External connection system		40-pin connector (accessory)	40-pin connector (sold separately)	○	Existing external wiring can be used.
Applicable wire size		0.3mm ²	0.3mm ² (A6CON1, A6CON4)	○	
Current consumption		0.075A (typ. all points on)	0.075A (typ. all points on)	○	
External dimensions		130(H)×34.5(W)×93.6(D)mm	98(H)×27.4(W)×90(D)mm	○	
Weight		0.19kg	0.15kg	○	

*1 When applying 5/12VDC, use the QX71.

*2 Check the specifications of the sensor or switches to be connected to the QX41-S2.

*3 The following shows the derating chart.

(A1SX71)

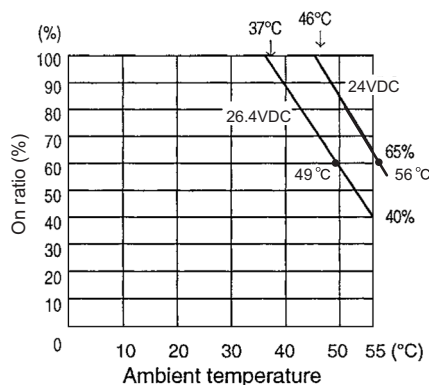

(QX41-S2)

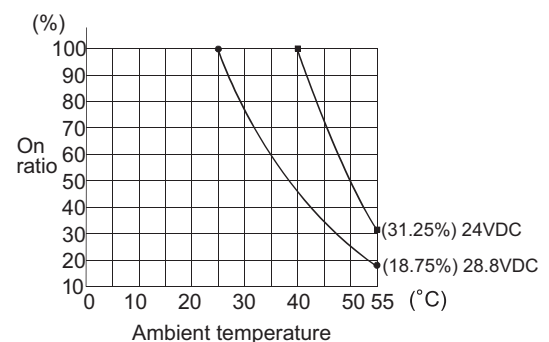

(24) Specifications comparison between A1SX71 and QX71

○ : Compatible, △ : Partially changed, × : Incompatible

Specifications		A1SX71	QX71	Compat- ibility	Precautions for replacement
Number of input points		32 points	32 points	○	
Isolation method		Photocoupler	Photocoupler	○	
Rated input voltage		5/12/24VDC	5/12VDC	△	24VDC is not applicable.*1
Rated input current		5VDC Approx. 1.2mA 12VDC Approx. 3.3mA 24VDC Approx. 7mA	5VDC Approx. 1.2mA 12VDC Approx. 3.3mA	△	24VDC is not applicable.*1
Operating voltage range		4.5 to 26.4VDC (ripple ratio within 5%)	4.5 to 6VDC (ripple ratio within 5%) 10.2 to 14.4VDC (ripple ratio within 5%)	△	24VDC is not applicable.*1
Maximum number of simultaneous input points		Refer to the derating chart.*2	Simultaneously on (100%)	○	
On voltage/on current		3.5VDC or more/1mA or more	3.5VDC or more/1mA or more	○	
Off voltage/off current		1VDC or less/0.1mA or less	1VDC or less/0.1mA or less	○	
Input resistance		Approx. 3.5kΩ	Approx. 3.3kΩ	○	
Response time	Off → on	1.5ms or less	1ms/5ms/10ms/20ms/70ms or less (Configure the setting in the PLC parameter dialog box.) 10ms is set by default.	○	The response time differs. Set the time according to the control.
	On → off	3ms or less	1ms/5ms/10ms/20ms/70ms or less (Configure the setting in the PLC parameter dialog box.) 10ms is set by default.	○	
Common terminal arrangement		32 points/common (common terminal: B1, B2)	32 points/common (common terminal: B01, B02)	○	
Operation indication		On indication (LED)	On indication (LED)	○	
External connection system		40-pin connector (accessory)	40-pin connector (sold separately)	○	Existing external wiring can be used.
Applicable wire size		0.3mm ²	0.3mm ² (A6CON1, A6CON4)	○	
Current consumption		0.075A (typ. all points on)	0.07A (typ. all points on)	○	
External dimensions		130(H)×34.5(W)×93.6(D)mm	98(H)×27.4(W)×90(D)mm	○	
Weight		0.19kg	0.12kg	○	

*1 When applying 24VDC, use the QX41-S1.

*2 The following shows the derating chart.

(A1SX71)

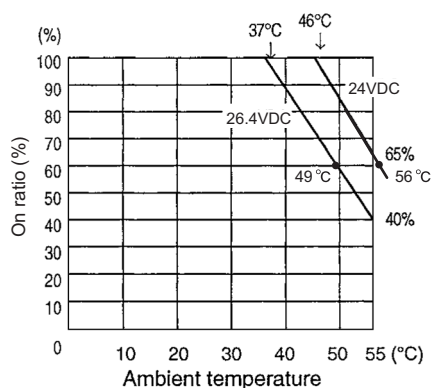

(25) Specifications comparison between A1SX80 and QX80

○: Compatible, △: Partially changed, ×: Incompatible

Specifications		A1SX80	QX80	Compat- ibility	Precautions for replacement
Number of input points		16 points	16 points	○	
Isolation method		Photocoupler	Photocoupler	○	
Rated input voltage		12/24VDC	24VDC	△	12VDC is not applicable.*1
Rated input current		Approx. 3mA/Approx. 7mA	Approx. 4mA	△	The rated input current is reduced.*2
Operating voltage range		10.2 to 26.4VDC (ripple ratio within 5%)	20.4 to 28.8VDC (ripple ratio within 5%)	△	12VDC is not applicable.*1
Maximum number of simultaneous input points		Simultaneously on (100%) (26.4VDC)	Simultaneously on (100%)	○	
On voltage/on current		8VDC or more/2mA or more	19VDC or more/3mA or more	△	12VDC is not applicable.*1*2
Off voltage/off current		4VDC or less/1mA or less	11VDC or less/1.7mA or less	△	12VDC is not applicable.*1*2
Input resistance		Approx. 3.3kΩ	Approx. 5.6kΩ	△	The input resistance is increased.*2
Response time	Off → on	10ms or less (24VDC)	1ms/5ms/10ms/20ms/70ms or less (Configure the setting in the PLC parameter dialog box.) 10ms is set by default.	○	Set the input response time of parameter to the default value (10ms).
	On → off	10ms or less (24VDC)	1ms/5ms/10ms/20ms/70ms or less (Configure the setting in the PLC parameter dialog box.) 10ms is set by default.	○	
Common terminal arrangement		16 points/common (common terminal: TB9, TB18)	16 points/common (common terminal: TB18)	○	
Operation indication		On indication (LED)	On indication (LED)	○	
External connection system		20-point terminal block connector (M3.5×7 screws)	18-point terminal block (M3×6 screws)	×	Wiring change is required.
Applicable wire size		0.75 to 1.25mm ²	Core: 0.3 to 0.75mm ² (outside diameter: 2.8mm (0.11 inches) or less)	×	
Applicable solderless terminal		R1.25-3.5, R2-3.5, RAV1.25-3.5, RAV2-3.5	R1.25-3 (Sleeved solderless terminal cannot be used.)	×	
Current consumption		0.05A (typ. all points on)	0.05A (typ. all points on)	○	
External dimensions		130(H)×34.5(W)×93.6(D)mm	98(H)×27.4(W)×90(D)mm	△	Wiring space is narrower.
Weight		0.20kg	0.16kg	○	

*1 When applying 12VDC, use the QX70.

*2 Check the specifications of the sensor or switches to be connected to the QX80.

(26) Specifications comparison between A1SX80 and QX70

○: Compatible, △: Partially changed, ×: Incompatible

Specifications		A1SX80	QX70	Compat- ibility	Precautions for replacement
Number of input points		16 points	16 points	○	
Isolation method		Photocoupler	Photocoupler	○	
Rated input voltage		12/24VDC	5/12VDC	△	24VDC is not applicable.*1
Rated input current		Approx. 3mA/Approx. 7mA	5VDC Approx.1.2mA 12VDC Approx.3.3mA	○	
Operating voltage range		10.2 to 26.4VDC (ripple ratio within 5%)	4.5 to 6VDC (ripple ratio within 5%) 10.2 to 14.4VDC (ripple ratio within 5%)	△	24VDC is not applicable.*1
Maximum number of simultaneous input points		Simultaneously on (100%) (26.4VDC)	Simultaneously on (100%)	○	
On voltage/on current		8VDC or more/2mA or more	3.5VDC or more/1mA or more	△	24VDC is not applicable.*1*2
Off voltage/off current		4VDC or less/1mA or less	1VDC or less/0.1mA or less	△	24VDC is not applicable.*1*2
Input resistance		Approx. 3.3kΩ	Approx. 3.3kΩ	○	
Response time	Off → on	10ms or less (24VDC)	1ms/5ms/10ms/20ms/70ms or less (Configure the setting in the PLC parameter dialog box.) 10ms is set by default.	○	Set the input response time of parameter to the default value (10ms).
	On → off	10ms or less (24VDC)	1ms/5ms/10ms/20ms/70ms or less (Configure the setting in the PLC parameter dialog box.) 10ms is set by default.	○	
Common terminal arrangement		16 points/common (common terminal: TB9, TB18)	16 points/common (common terminal: B01, B02)	○	
Operation indication		On indication (LED)	On indication (LED)	○	
External connection system		20-point terminal block connector (M3.5×7 screws)	18-point terminal block (M3×6 screws)	×	Wiring change is required.
Applicable wire size		0.75 to 1.25mm ²	Core: 0.3 to 0.75mm ² (outside diameter: 2.8mm (0.11 inches) or less)	×	
Applicable solderless terminal		R1.25-3.5, R2-3.5, RAV1.25-3.5, RAV2-3.5	R1.25-3 (Sleeved solderless terminal cannot be used.)	×	
Current consumption		0.05A (typ. all points on)	0.055A (typ. all points on)	○	
External dimensions		130(H)×34.5(W)×93.6(D)mm	98(H)×27.4(W)×90(D)mm	△	Wiring space is narrower.
Weight		0.20kg	0.14kg	○	

*1 When applying 24VDC, use the QX80.

*2 Check the specifications of the sensor or switches to be connected to the QX70.

(27) Specifications comparison between A1SX80-S1 and QX80

○: Compatible, △: Partially changed, ×: Incompatible

Specifications		A1SX80-S1	QX80	Compat- ibility	Precautions for replacement
Number of input points		16 points	16 points	○	
Isolation method		Photocoupler	Photocoupler	○	
Rated input voltage		24VDC	24VDC	○	
Rated input current		7mA	Approx. 4mA	△	The rated input current is reduced.*1
Operating voltage range		19.2 to 26.4VDC (ripple ratio within 5%)	20.4 to 28.8VDC (ripple ratio within 5%)	△	The operating voltage range differs.
Maximum number of simultaneous input points		Refer to the derating chart.*2	Simultaneously on (100%)	○	
On voltage/on current		17VDC or more/5mA or more	19VDC or more/3mA or more	△	The on voltage/on current differ.*1
Off voltage/off current		5VDC or less/1.7mA or less	11VDC or less/1.7mA or less	△	The off voltage differs.*1
Input resistance		Approx. 3.3kΩ	Approx. 5.6kΩ	△	The input resistance is increased.*1
Response time	Off → on	0.4ms (24VDC)	1ms/5ms/10ms/20ms/70ms or less (Configure the setting in the PLC parameter dialog box.) 10ms is set by default.	△	The response time differs. Set the time according to the control.
	On → off	0.5ms (24VDC)	1ms/5ms/10ms/20ms/70ms or less (Configure the setting in the PLC parameter dialog box.) 10ms is set by default.	△	
Common terminal arrangement		16 points/common (common terminal: TB9, TB18)	16 points/common (common terminal: TB18)	○	
Operation indication		On indication (LED)	On indication (LED)	○	
External connection system		20-point terminal block connector (M3.5×7 screws)	18-point terminal block (M3×6 screws)	×	Wiring change is required.
Applicable wire size		0.75 to 1.25mm ²	Core: 0.3 to 0.75mm ² (outside diameter: 2.8mm (0.11 inches) or less)	×	
Applicable solderless terminal		R1.25-3.5, R2-3.5, RAV1.25-3.5, RAV2-3.5	R1.25-3 (Sleeved solderless terminal cannot be used.)	×	
Current consumption		0.05A (typ. all points on)	0.05A (typ. all points on)	○	
External dimensions		130(H)×34.5(W)×93.6(D)mm	98(H)×27.4(W)×90(D)mm	△	Wiring space is narrower.
Weight		0.20kg	0.16kg	○	

*1 Check the specifications of the sensor or switches to be connected to the QX80.

*2 The following shows the derating chart.

(A1SX80-S1)

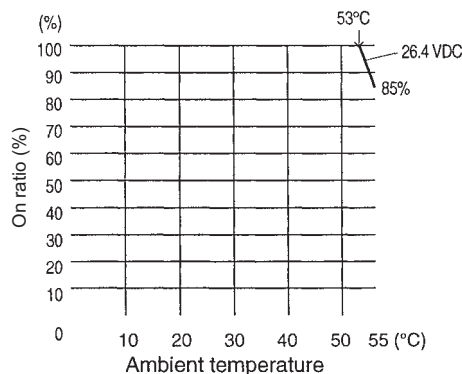

(28) Specifications comparison between A1SX80-S2 and QX80

○: Compatible, △: Partially changed, ×: Incompatible

Specifications		A1SX80-S2	QX80	Compat- ibility	Precautions for replacement
Number of input points		16 points	16 points	○	
Isolation method		Photocoupler	Photocoupler	○	
Rated input voltage		24VDC	24VDC	○	
Rated input current		Approx. 7mA	Approx. 4mA	△	The rated input current is reduced.*1
Operating voltage range		19.2 to 26.4VDC (ripple ratio within 5%)	20.4 to 28.8VDC (ripple ratio within 5%)	△	The operating voltage range differs.
Maximum number of simultaneous input points		Simultaneously on (100%) (26.4VDC)	Simultaneously on (100%)	○	
On voltage/on current		13VDC or more/3.5mA or more	19VDC or more/3mA or more	△	The on voltage/on current differ.*1
Off voltage/off current		6VDC or less/1.7mA or less	11VDC or less/1.7mA or less	△	The off voltage differs.*1
Input resistance		Approx. 3.3kΩ	Approx. 5.6kΩ	△	The input resistance is increased.*1
Response time	Off → on	10ms or less (24VDC)	1ms/5ms/10ms/20ms/70ms or less (Configure the setting in the PLC parameter dialog box.) 10ms is set by default.	○	Set the input response time of parameter to the default value (10ms).
	On → off	10ms or less (24VDC)	1ms/5ms/10ms/20ms/70ms or less (Configure the setting in the PLC parameter dialog box.) 10ms is set by default.	○	
Common terminal arrangement		16 points/common (common terminal: TB9, TB18)	16 points/common (common terminal: TB18)	○	
Operation indication		On indication (LED)	On indication (LED)	○	
External connection system		20-point terminal block connector (M3.5×7 screws)	18-point terminal block (M3×6 screws)	×	Wiring change is required.
Applicable wire size		0.75 to 1.25mm ²	Core: 0.3 to 0.75mm ² (outside diameter: 2.8mm (0.11 inches) or less)	×	
Applicable solderless terminal		R1.25-3.5, R2-3.5, RAV1.25-3.5, RAV2-3.5	R1.25-3 (Sleeved solderless terminal cannot be used.)	×	
Current consumption		0.05A (typ. all points on)	0.05A (typ. all points on)	○	
External dimensions		130(H)×34.5(W)×93.6(D)mm	98(H)×27.4(W)×90(D)mm	△	Wiring space is narrower.
Weight		0.20kg	0.16kg	○	

*1 Check the specifications of the sensor or switches to be connected to the QX80.

(29) Specifications comparison between A1SX81 and QX81

○: Compatible, △: Partially changed, ×: Incompatible

Specifications		A1SX81	QX81	Compatibility	Precautions for replacement
Number of input points		32 points	32 points	○	
Isolation method		Photocoupler	Photocoupler	○	
Rated input voltage		12/24VDC	24VDC	△	12VDC is not applicable.*1
Rated input current		Approx. 3mA/Approx. 7mA	Approx. 4mA	△	The rated input current is reduced.*2
Operating voltage range		10.2 to 26.4VDC (ripple ratio within 5%)	20.4 to 28.8VDC (ripple ratio within 5%)	△	12VDC is not applicable.*1
Maximum number of simultaneous input points		Refer to the derating chart.*3	Refer to the derating chart.*3	○	
On voltage/on current		8VDC or more/2mA or more	19VDC or more/3mA or more	△	12VDC is not applicable.*1*2
Off voltage/off current		4VDC or less/1mA or less	11VDC or less/1.7mA or less	△	12VDC is not applicable.*1*2
Input resistance		Approx. 3.3kΩ	Approx. 5.6kΩ	△	The input resistance is increased.*2
Response time	Off → on	10ms or less (24VDC)	1ms/5ms/10ms/20ms/70ms or less (Configure the setting in the PLC parameter dialog box.) 10ms is set by default.	○	Set the input response time of parameter to the default value (10ms).
	On → off	10ms or less (24VDC)	1ms/5ms/10ms/20ms/70ms or less (Configure the setting in the PLC parameter dialog box.) 10ms is set by default.	○	
Common terminal arrangement		32 points/common (common terminal: 17, 18, 36)	32 points/common (common terminal: 17, 18, 36)	○	
Operation indication		On indication (LED)	On indication (LED)	○	
External connection system		37-pin D-sub connector (accessory)	37-pin D-sub connector (sold separately)	○	Existing external wiring can be used.
Applicable wire size		0.3mm ²	0.3mm ² (A6CON1E)	○	Note that the connecting direction of the connector is inverted.
Current consumption		0.08A (typ. all points on)	0.075A (typ. all points on)	○	
External dimensions		130(H)×34.5(W)×93.6(D)mm	98(H)×27.4(W)×90(D)mm	○	
Weight		0.24kg	0.16kg	○	

*1 When applying 12VDC, use the QX71.

*2 Check the specifications of the sensor or switches to be connected to the QX81.

*3 The following shows the derating chart.

(A1SX81)

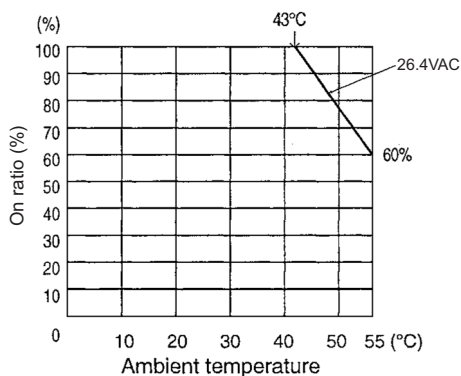

(QX81)

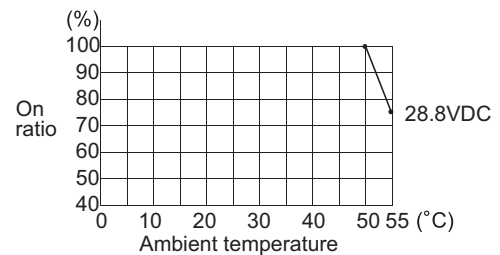

(30) Specifications comparison between A1SX81 and QX81-S2

○: Compatible, △: Partially changed, ×: Incompatible

Specifications		A1SX81	QX81-S2	Compat- ibility	Precautions for replacement
Number of input points		32 points	32 points	○	
Isolation method		Photocoupler	Photocoupler	○	
Rated input voltage		12/24VDC	24VDC	△	12VDC is not applicable.*1
Rated input current		Approx. 3mA/Approx. 7mA	Approx. 6mA	△	The rated input current is reduced.*2
Operating voltage range		10.2 to 26.4VDC (ripple ratio within 5%)	20.4 to 28.8VDC (ripple ratio within 5%)	△	12VDC is not applicable.*1
Maximum number of simultaneous input points		Refer to the derating chart.*3	Refer to the derating chart.*3	△	Use it within the range shown in the derating chart.
On voltage/on current		8VDC or more/2mA or more	15VDC or more/3mA or more	△	12VDC is not applicable.*1*2
Off voltage/off current		4VDC or less/1mA or less	5VDC or less/1.7mA or less	△	12VDC is not applicable.*1*2
Input resistance		Approx. 3.3kΩ	Approx. 3.6kΩ	△	The input resistance is increased.*2
Response time	Off → on	10ms or less (24VDC)	1ms/5ms/10ms/20ms/70ms or less (Configure the setting in the PLC parameter dialog box.) 10ms is set by default.	○	Set the input response time of parameter to the default value (10ms).
	On → off	10ms or less (24VDC)	1ms/5ms/10ms/20ms/70ms or less (Configure the setting in the PLC parameter dialog box.) 10ms is set by default.	○	
Common terminal arrangement		32 points/common (common terminal: 17, 18, 36)	32 points/common (common terminal: 17, 18, 36)	○	
Operation indication		On indication (LED)	On indication (LED)	○	
External connection system		37-pin D-sub connector (accessory)	37-pin D-sub connector (sold separately)	○	Existing external wiring can be used.
Applicable wire size		0.3mm ²	0.3mm ² (A6CON1E)	○	Note that the connecting direction of the connector is inverted.
Current consumption		0.08A (typ. all points on)	0.075A (typ. all points on)	○	
External dimensions		130(H)×34.5(W)×93.6(D)mm	98(H)×27.4(W)×90(D)mm	○	
Weight		0.24kg	0.16kg	○	

*1 When applying 12VDC, use the QX71.

*2 Check the specifications of the sensor or switches to be connected to the QX81-S2.

*3 The following shows the derating chart.

(A1SX81)

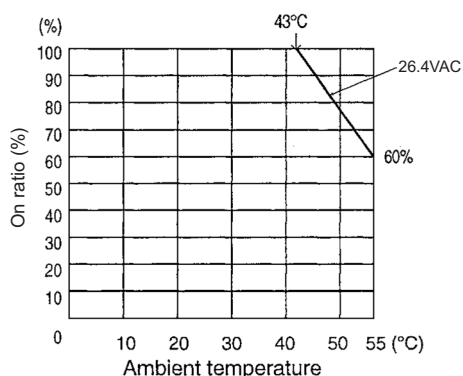

(QX81-S2)

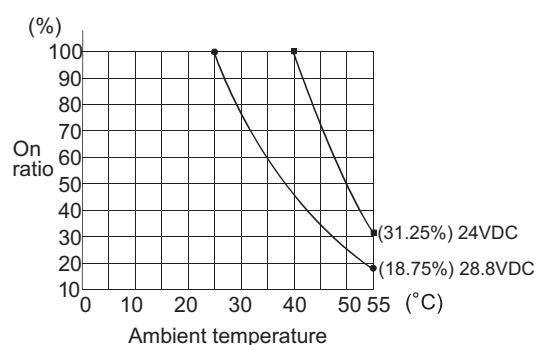

(31) Specifications comparison between A1SX81 and QX71

○: Compatible, △: Partially changed, ×: Incompatible

Specifications		A1SX81	QX71	Compatibility	Precautions for replacement
Number of input points		32 points	32 points	○	
Isolation method		Photocoupler	Photocoupler	○	
Rated input voltage		12/24VDC	5/12VDC	△	24VDC is not applicable.*1
Rated input current		Approx. 3mA/Approx. 7mA	5VDC Approx. 1.2mA 12VDC Approx. 3.3mA	○	
Operating voltage range		10.2 to 26.4VDC (ripple ratio within 5%)	4.5 to 6VDC (ripple ratio within 5%) 10.2 to 14.4VDC (ripple ratio within 5%)	△	24VDC is not applicable.*1
Maximum number of simultaneous input points		Refer to the derating chart.*3	Simultaneously on (100%)	○	
On voltage/on current		8VDC or more/2mA or more	3.5VDC or more/1mA or more	△	24VDC is not applicable.*1*2
Off voltage/off current		4VDC or less/1mA or less	1VDC or less/0.1mA or less	△	24VDC is not applicable.*1*2
Input resistance		Approx. 3.3kΩ	Approx. 3.3kΩ	○	
Response time	Off → on	10ms or less (24VDC)	1ms/5ms/10ms/20ms/70ms or less (Configure the setting in the PLC parameter dialog box.) 10ms is set by default.	○	Set the input response time of parameter to the default value (10ms).
	On → off	10ms or less (24VDC)	1ms/5ms/10ms/20ms/70ms or less (Configure the setting in the PLC parameter dialog box.) 10ms is set by default.	○	
Common terminal arrangement		32 points/common (common terminal: 17, 18, 36)	32 points/common (common terminal: B01, B02)	○	
Operation indication		On indication (LED)	On indication (LED)	○	
External connection system		37-pin D-sub connector (accessory)	40-pin connector (sold separately)	×	Wiring change is required.
Applicable wire size		0.3mm ²	0.3mm ² (A6CON1, A6CON4)	×	
Current consumption		0.08A (typ. all points on)	0.07A (typ. all points on)	○	
External dimensions		130(H)×34.5(W)×93.6(D)mm	98(H)×27.4(W)×90(D)mm	○	
Weight		0.24kg	0.12kg	○	

*1 When applying 24VDC, use the QX81.

*2 Check the specifications of the sensor or switches to be connected to the QX71.

*3 The following shows the derating chart.

(A1SX81)

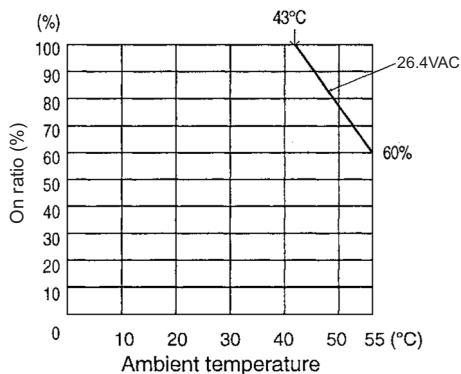

(32) Specifications comparison between A1SX81-S2 and QX81

○: Compatible, △: Partially changed, ×: Incompatible

Specifications		A1SX81-S2	QX81	Compat- ibility	Precautions for replacement
Number of input points		32 points	32 points	○	
Isolation method		Photocoupler	Photocoupler	○	
Rated input voltage		24VDC	24VDC	○	
Rated input current		Approx. 7mA	Approx. 4mA	△	The rated input current is reduced.*1
Operating voltage range		19.2 to 26.4VDC (ripple ratio within 5%)	20.4 to 28.8VDC (ripple ratio within 5%)	△	The operating voltage range differs.
Maximum number of simultaneous input points		Refer to the derating chart.*2	Refer to the derating chart.*2	○	
On voltage/on current		13VDC or more/3.5mA or more	19VDC or more/3mA or more	△	The on voltage/on current differ.*1
Off voltage/off current		6VDC or less/1.7mA or less	11VDC or less/1.7mA or less	△	The off voltage differs.*1
Input resistance		Approx. 3.3kΩ	Approx. 5.6kΩ	△	The input resistance is increased.*1
Response time	Off → on	10ms or less (24VDC)	1ms/5ms/10ms/20ms/70ms or less (Configure the setting in the PLC parameter dialog box.) 10ms is set by default.	○	Set the input response time of parameter to the default value (10ms).
	On → off	10ms or less (24VDC)	1ms/5ms/10ms/20ms/70ms or less (Configure the setting in the PLC parameter dialog box.) 10ms is set by default.	○	
Common terminal arrangement		32 points/common (common terminal: 17, 18, 36)	32 points/common (common terminal: 17, 18, 36)	○	
Operation indication		On indication (LED)	On indication (LED)	○	
External connection system		37-pin D-sub connector (accessory)	37-pin D-sub connector (sold separately)	○	Existing external wiring can be used. Note that the connecting direction of the connector is inverted.
Applicable wire size		0.3mm ²	0.3mm ² (A6CON1E)	○	
Current consumption		0.08A (typ. all points on)	0.075A (typ. all points on)	○	
External dimensions		130(H)×34.5(W)×93.6(D)mm	98(H)×27.4(W)×90(D)mm	○	
Weight		0.24kg	0.16kg	○	

*1 Check the specifications of the sensor or switches to be connected to the QX81.

*2 The following shows the derating chart.

(A1SX81-S2)

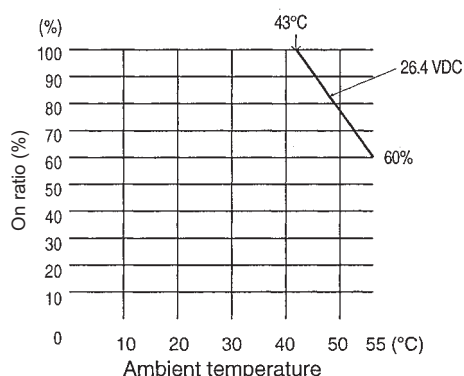

(QX81)

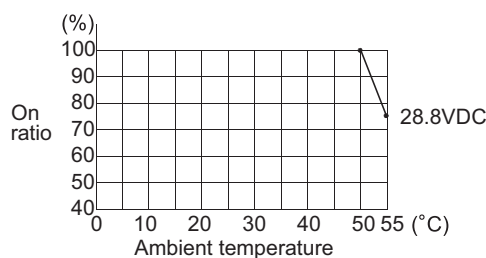

(33) Specifications comparison between A1SX81-S2 and QX81-S2

○: Compatible, △: Partially changed, ×: Incompatible

Specifications		A1SX81-S2	QX81-S2	Compatibility	Precautions for replacement
Number of input points		32 points	32 points	○	
Isolation method		Photocoupler	Photocoupler	○	
Rated input voltage		24VDC	24VDC	○	
Rated input current		Approx. 7mA	Approx. 6mA	△	The rated input current is reduced.*1
Operating voltage range		19.2 to 26.4VDC (ripple ratio within 5%)	20.4 to 28.8VDC (ripple ratio within 5%)	△	The operating voltage range differs.
Maximum number of simultaneous input points		Refer to the derating chart.*2	Refer to the derating chart.*2	△	Use it within the range shown in the derating chart.
On voltage/on current		13VDC or more/3.5mA or more	15VDC or more/3mA or more	△	The on voltage/on current differs.*1
Off voltage/off current		6VDC or less/1.7mA or less	5VDC or less/1.7mA or less	△	The off voltage differs.*1
Input resistance		Approx. 3.3kΩ	Approx. 3.6kΩ	△	The input resistance is increased.*1
Response time	Off → on	10ms or less (24VDC)	1ms/5ms/10ms/20ms/70ms or less (Configure the setting in the PLC parameter dialog box.) 10ms is set by default.	○	Set the input response time of parameter to the default value (10ms).
	On → off	10ms or less (24VDC)	1ms/5ms/10ms/20ms/70ms or less (Configure the setting in the PLC parameter dialog box.) 10ms is set by default.	○	
Common terminal arrangement		32 points/common (common terminal: 17, 18, 36)	32 points/common (common terminal: 17, 18, 36)	○	
Operation indication		On indication (LED)	On indication (LED)	○	
External connection system		37-pin D-sub connector (accessory)	37-pin D-sub connector (sold separately)	○	Existing external wiring can be used.
Applicable wire size		0.3mm ²	0.3mm ² (A6CON1E)	○	Note that the connecting direction of the connector is inverted.
Current consumption		0.08A (typ. all points on)	0.075A (typ. all points on)	○	
External dimensions		130(H)×34.5(W)×93.6(D)mm	98(H)×27.4(W)×90(D)mm	○	
Weight		0.24kg	0.16kg	○	

*1 Check the specifications of the sensor or switches to be connected to the QX81-S2.

*2 The following shows the derating chart.

(A1SX81-S2)

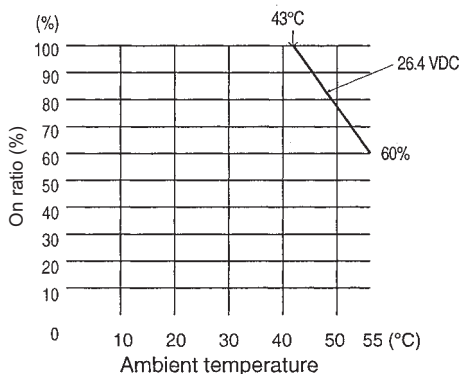

(QX81-S2)

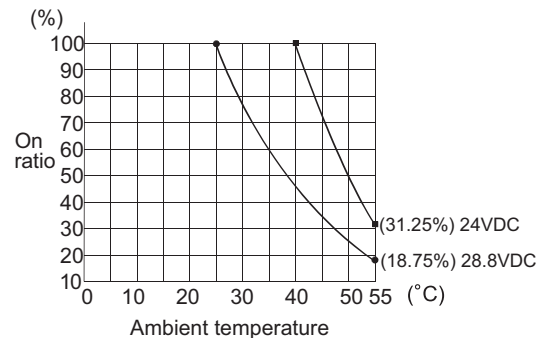

(34) Specifications comparison between A1SX82-S1 and QX82-S1

○: Compatible, △: Partially changed, ×: Incompatible

Specifications		A1SX82-S1	QX82-S1	Compat- ibility	Precautions for replacement
Number of input points		64 points	64 points	○	
Isolation method		Photocoupler	Photocoupler	○	
Rated input voltage		24VDC	24VDC	○	
Rated input current		Approx. 5mA	Approx. 4mA	△	The rated input current is reduced.*1
Operating voltage range		19.2 to 26.4VDC (ripple ratio within 5%)	20.4 to 28.8VDC (ripple ratio within 5%)	△	The operating voltage range differs.
Maximum number of simultaneous input points		Simultaneously on (50%) (16 points/common) (24VDC)	Refer to the derating chart.*2	○	
On voltage/on current		18.5VDC or more/3.5mA or more	19VDC or more/3mA or more	△	The on voltage/on current differ.*1
Off voltage/off current		3VDC or less/0.45mA or less	9.5VDC or less/1.5mA or less	△	The off voltage/off current differ.*1
Input resistance		Approx. 4.7kΩ	Approx. 5.6kΩ	△	The input resistance is increased.*1
Response time	Off → on	0.3ms or less (24VDC)	0.1ms/0.2ms/0.4ms/0.6ms/1ms or less (Configure the setting in the PLC parameter dialog box.) 0.2ms is set by default.	○	The response time differs. Set the time according to the control.
	On → off	0.3ms or less (24VDC)	0.1ms/0.2ms/0.4ms/0.6ms/1ms or less (Configure the setting in the PLC parameter dialog box.) 0.2ms is set by default.	○	
Common terminal arrangement		32 points/common (common terminal: 1B1, 1B2, 2B1, 2B2)	32 points/common (common terminal: 1B01, 1B02, 2B01, 2B02)	○	
Operation indication		On indication (LED) 32-point switching indication with the switch	On indication (LED) 32-point switching indication with the switch	○	
External connection system		40-pin connector 2 pieces (accessory)	40-pin connector 2 pieces (sold separately)	○	Existing external wiring can be used.
Applicable wire size		0.3mm ²	0.3mm ² (A6CON1, A6CON4)	○	
Current consumption		0.16A (typ. all points on)	0.09A (typ. all points on)	○	
External dimensions		130(H)×34.5(W)×93.6(D)mm	98(H)×27.4(W)×90(D)mm	○	
Weight		0.28kg	0.18kg	○	

*1 Check the specifications of the sensor or switches to be connected to the QX82-S1.

*2 The following shows the derating chart.

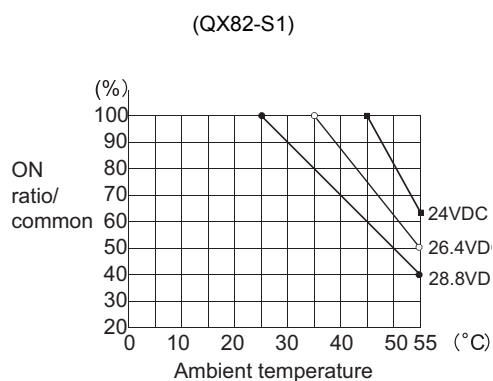

3.2.2 Comparison of output module specifications

(1) Specifications comparison between A1SY10 and QY10

○: Compatible, △: Partially changed, ×: Incompatible

Specifications		A1SY10	QY10	Compat- ibility	Precautions for replacement
Number of output points		16 points	16 points	○	
Isolation method		Photocoupler	Relay	△	The isolation method differs, but the performance is the equivalent.
Rated switching voltage/ current		24VDC 2A (resistance load)/point 240VAC 2A (COSφ=1)/point 8A/common	24VDC 2A (resistance load)/point 240VAC 2A (COSφ=1)/point 8A/common	○	
Minimum switching load		5VDC 1mA	5VDC 1mA	○	
Maximum switching voltage		264VAC 125VDC	264VAC 125VDC	○	
Response time	Off → on	10ms or less	10ms or less	○	
	On → off	12ms or less	12ms or less	○	
Life	Mechanical	20 million times or more	20 million times or more	○	
	Electrical	Rated switching voltage/ current load 100,000 times or more	Rated switching voltage/ current load 100,000 times or more	○	
		200VAC 1.5A, 240VAC 1A (COSφ=0.7) 100,000 times or more 200VAC 1A, 240VAC 0.5A (COSφ=0.35) 100,000 times or more 24VDC 1A, 100VDC 0.1A (L/R=7ms) 100,000 times or more	200VAC 1.5A, 240VAC 1A (COSφ=0.7) 100,000 times or more 200VAC 0.4A, 240VAC 0.3A (COSφ=0.7) 300,000 times or more 200VAC 1A, 240VAC 0.5A (COSφ=0.35) 100,000 times or more 200VAC 0.3A, 240VAC 0.15A (COSφ=0.35) 300,000 times or more 24VDC 1A, 100VDC 0.1A (L/R=7ms) 100,000 times or more 24VDC 0.3A, 100VDC 0.03A (L/R=7ms) 300,000 times or more	○	
Maximum switching frequency	3600 times/hr	3600 times/hr	○		
Surge suppressor		None	None	-	
Common terminal arrangement		8 points/common (common terminal: TB9, TB18)	16 points/common (common terminal: TB17)	△	As the common is changed from 2 commons to 1 common, wiring with a different voltage for each common is not possible.
Operation indication		On indication (LED)	On indication (LED)	○	
Fuse		None	None	-	
External power supply	Voltage	24VDC±10% Ripple voltage 4Vp-p or less	-	○	An external power supply is not required.
	Current	90mA (typ. 24VDC, all points on)	-	○	
External connection system		20-point terminal block connector (M3.5×7 screws)	18-point terminal block (M3×6 screws)	×	Wiring change is required.
Applicable wire size		0.75 to 1.25mm ²	Core: 0.3 to 0.75mm ² (outside diameter: 2.8mm (0.11 inches) or less)	×	
Applicable solderless terminal		R1.25-3.5, R2-3.5, RAV1.25-3.5, RAV2-3.5	R1.25-3 (Sleeved solderless terminal cannot be used.)	×	
Current consumption		0.12A (typ. all points on)	0.43A (typ. all points on)	△	Review the current capacity since the current consumption is increased.
External dimensions		130(H)×34.5(W)×93.6(D)mm	98(H)×27.4(W)×90(D)mm	△	Wiring space is narrower.
Weight		0.25kg	0.22kg	○	

(2) Specifications comparison between A1SY10EU and QY10

○: Compatible, △: Partially changed, ×: Incompatible

Specifications		A1SY10EU	QY10	Compat- ibility	Precautions for replacement
Number of output points		16 points	16 points	○	
Isolation method		Photocoupler	Relay	△	The isolation method differs, but the performance is the equivalent.
Rated switching voltage/ current		24VDC 2A (resistance load)/point 24VAC 2A (COSφ=1)/point 8A/common	24VDC 2A (resistance load)/point 240VAC 2A (COSφ=1)/point 8A/common	○	
Minimum switching load		5VDC 1mA	5VDC 1mA	○	
Maximum switching voltage		132VAC 125VDC	264VAC 125VDC	○	
Response time	Off → on	10ms or less	10ms or less	○	
	On → off	12ms or less	12ms or less	○	
Life	Mechanical	20 million times or more	20 million times or more	○	
	Electrical	Rated switching voltage/current load 200,000 times or more	Rated switching voltage/current load 100,000 times or more	△	Replace the module more frequently because the life cycle is reduced by approximately half.
		100VAC 2A, 120VAC 2A (COSφ=0.7) 200,000 times or more 100VAC 2A, 120VAC 2A (COSφ=0.35) 100,000 times or more 24VDC 1.5A, 100VDC 0.1A (L/R=7ms) 100,000 times or more	200VAC 1.5A, 240VAC 1A (COSφ=0.7) 100,000 times or more 200VAC 0.4A, 240VAC 0.3A (COSφ=0.7) 300,000 times or more 200VAC 1A, 240VAC 0.5A (COSφ=0.35) 100,000 times or more 200VAC 0.3A, 240VAC 0.15A (COSφ=0.35) 300,000 times or more 24VDC 1A, 100VDC 0.1A (L/R=7ms) 100,000 times or more 24VDC 0.3A, 100VDC 0.03A (L/R=7ms) 300,000 times or more	△	
Maximum switching frequency	3600 times/hr	3600 times/hr	○		
Surge suppressor		None	None	-	
Common terminal arrangement		8 points/common (common terminal: TB9, TB18)	16 points/common (common terminal: TB17)	△	As the common is changed from 2 commons to 1 common, wiring with a different voltage for each common is not possible.
Operation indication		On indication (LED)	On indication (LED)	○	
Fuse		None	None	-	
External power supply	Voltage	24VDC±10% Ripple voltage 4Vp-p or less	-	○	An external power supply is not required.
	Current	90mA (typ. 24VDC, all points on)	-	○	
External connection system		20-point terminal block connector (M3.5×7 screws)	18-point terminal block (M3×6 screws)	×	Wiring change is required.
Applicable wire size		0.75 to 1.25mm ² (16 to 19 AWG)	Core: 0.3 to 0.75mm ² (outside diameter: 2.8mm (0.11 inches) or less)	×	
Applicable solderless terminal		RAV1.25-3.5	R1.25-3 (Sleeved solderless terminal cannot be used.)	×	
Dielectric withstand voltage		(Between AC external batch and relay drive power supply, 5V internal circuit) 1780VAC rms/3 cycles (altitude 2,000m (6562ft.)) (Between relay-drive power supply and 5V internal circuit) 500VAC rms/3 cycles (altitude 2,000m (6562ft.))	2830VAC rms/3 cycles (altitude 2,000m (6562ft.))	○	
Insulation resistance		10MΩ or more with an insulation resistance tester	10MΩ or more with an insulation resistance tester	○	
Current consumption		0.12A (typ. all points on)	0.43A (typ. all points on)	△	Review the current capacity since the current consumption is increased.
External dimensions		130(D)×34.5(W)×93.6(D)mm	98(H)×27.4(W)×90(D)mm	△	Wiring space is narrower.
Weight		0.25kg	0.22kg	○	

(3) Specifications comparison between A1SY14EU and QY10

○: Compatible, △: Partially changed, ×: Incompatible

Specifications		A1SY14EU	QY10	Compat- ibility	Precautions for replacement
Number of output points		12 points (16 points occupied)	16 points	○	
Isolation method		Photocoupler	Relay	△	The isolation method differs, but the performance is the equivalent.
Rated switching voltage/ current		24VDC 2A (resistance load)/point 240VAC 2A (COSφ=1)/point 8A/common	24VDC 2A (resistance load)/point 240VAC 2A (COSφ=1)/point 8A/common	○	
Minimum switching load		5VDC 10mA	5VDC 1mA	○	
Maximum switching voltage		264VAC 125VDC	264VAC 125VDC	○	
Response time	Off → on	10ms or less	10ms or less	○	
	On → off	12ms or less	12ms or less	○	
Life	Mechanical	20 million times or more	20 million times or more	○	
	Electrical	Rated switching voltage/current load 200,000 times or more	Rated switching voltage/current load 100,000 times or more	△	Replace the module more frequently because the life cycle is reduced by approximately half.
		200VAC 2A, 240VAC 1.8A (COSφ=0.7) 200,000 times or more 200VAC 1.1A, 240VAC 0.9A (COSφ=0.35) 200,000 times or more 24VDC 1.1A, 100VDC 0.1A (L/R=7ms) 200,000 times or more	200VAC 1.5A, 240VAC 1A (COSφ=0.7) 100,000 times or more 200VAC 0.4A, 240VAC 0.3A (COSφ=0.7) 300,000 times or more 200VAC 1A, 240VAC 0.5A (COSφ=0.35) 100,000 times or more 200VAC 0.3A, 240VAC 0.15A (COSφ=0.35) 300,000 times or more 24VDC 1A, 100VDC 0.1A (L/R=7ms) 100,000 times or more 24VDC 0.3A, 100VDC 0.03A (L/R=7ms) 300,000 times or more	△	
Maximum switching frequency	3600 times/hr	3600 times/hr	○		
Surge suppressor		None	None	○	
Common terminal arrangement		4 points/common (common terminal: TB5, TB10, TB15)	16 points/common (common terminal: TB17)	△	As the common is changed from 3 commons to 1 common, wiring with a different voltage for each common is not possible.
Operation indication		On indication (LED)	On indication (LED)	○	
Fuse		None	None	-	
External power supply	Voltage	24VDC±10% Ripple voltage 4Vp-p or less	-	○	An external power supply is not required.
	Current	100mA (typ. 24VDC, all points on) (must be SELV power supply.)	-	○	
External connection system		20-point terminal block connector (M3.5×7 screws)	18-point terminal block (M3×6 screws)	×	Wiring change is required.
Applicable wire size		0.75 to 1.25mm ² (16 to 19 AWG)	Core: 0.3 to 0.75mm ² (outside diameter: 2.8mm (0.11 inches) or less)	×	
Applicable solderless terminal		RAV1.25-3.5	R1.25-3 (Sleeved solderless terminal cannot be used.)	×	
Dielectric withstand voltage		(Between AC external batch and relay drive power supply, 5V internal circuit) 2830VAC rms/3 cycles (altitude 2,000m (6562ft.)) (Between relay-drive power supply and 5V internal circuit) 500VAC rms/3 cycles (altitude 2,000m (6562ft.))	AC2830V rms/3 cycles (altitude 2,000m (6562ft.))	○	
Insulation resistance		10MΩ or more with an insulation resistance tester	10MΩ or more with an insulation resistance tester	○	

Specifications	A1SY14EU	QY10	Compat- ibility	Precautions for replacement
Noise immunity	IEC801-4: 1kV	<ul style="list-style-type: none"> • By noise simulator of 1500Vp-p noise voltage, 1μs noise width, and 25 to 60Hz noise frequency • First transient noise IEC61000-4-4: 1kV 	○	
Current consumption	0.12A (typ. all points on)	0.43A (typ. all points on)	△	Review the current capacity since the current consumption is increased.
External dimensions	130(H)×34.5(W)×93.6(D)mm	98(H)×27.4(W)×90(D)mm	△	Wiring space is narrower.
Weight	0.25kg	0.22kg	○	

(4) Specifications comparison between A1SY18A and QY18A

○: Compatible, △: Partially changed, ×: Incompatible

Specifications		A1SY18A	QY18A	Compatibility	Precautions for replacement
Number of output points		8 points (16 points occupied)	8 points (16 points occupied)	○	
Isolation method		Photocoupler	Relay	△	The isolation method differs, but the performance is the equivalent.
Rated switching voltage/current		24VDC 2A (resistance load)/point 240VAC 2A (COSφ=1)/point 8A/module	24VDC 2A (resistance load)/point 240VAC 2A (COSφ=1)/point 8A/module	○	
Minimum switching load		5VDC 1mA	5VDC 1mA	○	
Maximum switching voltage		264VAC 125VDC	264VAC 125VDC	○	
Response time	Off → on	10ms or less	10ms or less	○	
	On → off	12ms or less	12ms or less	○	
Life	Mechanical	20 million times or more	20 million times or more	○	
	Electrical	Rated switching voltage/current load 200,000 times or more 200VAC 1.5A, 240VAC 1A (COSφ=0.7) 200,000 times or more 200VAC 0.75A, 240VAC 0.5A (COSφ=0.35) 200,000 times or more 24VDC 1A, 100VDC 0.1A (L/R=7ms) 200,000 times or more	Rated switching voltage/current load 100,000 times or more 200VAC 1.5A, 240VAC 1A (COSφ=0.7) 100,000 times or more 200VAC 0.4A, 240VAC 0.3A (COSφ=0.7) 300,000 times or more 200VAC 1A, 240VAC 0.5A (COSφ=0.35) 100,000 times or more 200VAC 0.3A, 240VAC 0.15A (COSφ=0.35) 300,000 times or more 24VDC 1A, 100VDC 0.1A (L/R=7ms) 100,000 times or more 24VDC 0.3A, 100VDC 0.03A (L/R=7ms) 300,000 times or more	△	Replace the module more frequently because the life cycle is reduced by approximately half.
Maximum switching frequency		3600 times/hr	3600 times/hr	○	
Common terminal arrangement		All points independent common	All points independent common	○	
Operation indication		On indication (LED)	On indication (LED)	○	
Fuse		None	None	-	
External power supply	Voltage	24VDC±10% Ripple voltage 4Vp-p or less	-	○	An external power supply is not required.
	Current	75mA (typ. 24VDC, all points on)	-	○	
External connection system		20-point terminal block connector (M3.5×7 screws)	18-point terminal block (M3×6 screws)	×	Wiring change is required.
Applicable wire size		0.75 to 1.25mm ²	Core: 0.3 to 0.75mm ² (outside diameter: 2.8mm (0.11 inches) or less)	×	
Applicable solderless terminal		R1.25-3.5, R2-3.5, RAV1.25-3.5, RAV2-3.5	R1.25-3 (Sleeved solderless terminal cannot be used.)	×	
Current consumption		0.24A (typ. all points on)	0.24A (typ. all points on)	○	
External dimensions		130(H)×34.5(W)×93.6(D)mm	98(H)×27.4(W)×90(D)mm	△	Wiring space is narrower.
Weight		0.25kg	0.22kg	○	

(5) Specifications comparison between A1SY18AEU and QY18A

○ : Compatible, △ : Partially changed, × : Incompatible

Specifications		A1SY18AEU	QY18A	Compat- ibility	Precautions for replacement
Number of output points		8 points (16 points occupied)	8 points (16 points occupied)	○	
Isolation method		Photocoupler	Relay	△	The isolation method differs, but the performance is the equivalent.
Rated switching voltage/ current		24VDC 2A (resistance load)/point 24VAC 2A (COSφ=1)/point 8A/module	24VDC 2A (resistance load)/point 240VAC 2A (COSφ=1)/point 8A/module	○	
Minimum switching load		5VDC 1mA	5VDC 1mA	○	
Maximum switching voltage		264VAC 125VDC	264VAC 125VDC	○	
Response time	Off → on	10ms or less	10ms or less	○	
	On → off	12ms or less	12ms or less	○	
Life	Mechanical	20 million times or more	20 million times or more	○	
	Electrical	Rated switching voltage/current load 200,000 times or more	Rated switching voltage/current load 100,000 times or more	△	Replace the module more frequently because the life cycle is reduced by approximately half.
		200VAC 1.5A, 240VAC 1A (COSφ=0.7) 200,000 times or more 200VAC 0.75A, 240VAC 0.5A (COSφ=0.35) 200,000 times or more 24VDC 1A, 100VDC 0.1A (L/R=7ms) 200,000 times or more	200VAC 1.5A, 240VAC 1A (COSφ=0.7) 100,000 times or more 200VAC 0.4A, 240VAC 0.3A (COSφ=0.7) 300,000 times or more 200VAC 1A, 240VAC 0.5A (COSφ=0.35) 100,000 times or more 200VAC 0.3A, 240VAC 0.15A (COSφ=0.35) 300,000 times or more 24VDC 1A, 100VDC 0.1A (L/R=7ms) 100,000 times or more 24VDC 0.3A, 100VDC 0.03A (L/R=7ms) 300,000 times or more	△	
Maximum switching frequency	3600 times/hr	3600 times/hr	○		
Surge suppressor		None	None	-	
Common terminal arrangement		All points independent common	All points independent common	○	
Operation indication		On indication (LED)	On indication (LED)	○	
Fuse		None	None	-	
External power supply	Voltage	24VDC±10% Ripple voltage 4Vp-p or less	-	○	An external power supply is not required.
	Current	75mA (typ. 24VDC, all points on)	-	○	
External connection system		20-point terminal block connector (M3.5×7 screws)	18-point terminal block (M3×6 screws)	×	Wiring change is required.
Applicable wire size		0.75 to 1.25mm ² (16 to 19 AWG)	Core: 0.3 to 0.75mm ² (outside diameter: 2.8mm (0.11 inches) or less)	×	
Applicable solderless terminal		RAV1.25-3.5	R1.25-3 (Sleeved solderless terminal cannot be used.)	×	
Dielectric withstand voltage		(Between AC external batch and relay drive power supply, 5V internal circuit) 2830VAC rms/3 cycles (altitude 2,000m (6562ft.)) (Between relay-drive power supply and 5V internal circuit) 500VAC rms/3 cycles (altitude 2,000m (6562ft))	2830VAC rms/3 cycles (altitude 2,000m (6562ft.))	○	
Insulation resistance		10MΩ or more with an insulation resistance tester	10MΩ or more with an insulation resistance tester	○	
Noise immunity		IEC801-4: 1kV	<ul style="list-style-type: none"> By noise simulator of 1500Vp-p noise voltage, 1μs noise width, and 25 to 60Hz noise frequency First transient noise IEC61000-4- 4: 1kV 	○	

Specifications	A1SY18AEU	QY18A	Compat- ibility	Precautions for replacement
Current consumption	0.24A (typ. all points on)	0.24A (typ. all points on)	○	
External dimensions	130(H)×34.5(W)×93.6(D)mm	98(H)×27.4(W)×90(D)mm	△	Wiring space is narrower.
Weight	0.25kg	0.22kg	○	

(6) Specifications comparison between A1SY22 and QY22

○: Compatible, △: Partially changed, ×: Incompatible

Specifications		A1SY22	QY22	Compat- ibility	Precautions for replacement
Number of output points		16 points	16 points	○	
Isolation method		Photocoupler	Photocoupler	○	
Rated load voltage		100/240VAC 50/60Hz ±3Hz	100 to 240VAC 50/60Hz ±5%	○	
Maximum load voltage		264VAC	264VAC	○	
Maximum load current		0.6A/point, 2.4A/common	0.6A/point, 4.8A/common	○	
Minimum load voltage/ current		24VAC 100mA 100VAC 10mA 240VAC 20mA	24VAC 100mA 100VAC 25mA 240VAC 25mA	△	Carefully select a load for use since the minimum load current is increased.
Maximum inrush current		20A 10ms or less 8A 100ms or less	20A 1 cycle or less	○	
Leakage current at off		1.5mA (120VAC 60Hz) 3mA (240VAC 60Hz)	1.5mA or less (120V 60Hz) 3mA or less (240V 60Hz)	○	
Maximum voltage drop at on		1.5VAC or less (0.1 to 0.6A) 1.8VAC or less (50 to 100mA) 2VAC or less (10 to 50mA)	1.5V or less	○	
Response time	Off → on	1ms or less	1ms + 0.5 cycles or less	○	
	On → off	1ms + 0.5 cycles or less	1ms + 0.5 cycles or less (rated load, resistance load)	○	
Surge suppressor		CR absorber (0.01μF + 47Ω)	CR absorber	○	
Common terminal arrangement		8 points/common (common terminal: TB9, TB18)	16 points/common (common terminal: TB17)	△	As the common is changed from 2 commons to 1 common, wiring with a different voltage for each common is not possible.
Operation indication		On indication (LED)	On indication (LED)	○	
Fuse rating (breaking capacity)		5A (1 fuse/common) Cannot be changed.	None (Connecting a fuse to external wiring is recommended.)	×	Fuses are not built in.*1
Fuse blown indication		Available (LED turns on when a fuse is blown and a signal is output to the CPU module.)			
External power supply	Voltage	100-240VAC (85 to 264VAC)	-	○	An external power supply is not required.
	Current	2mA (typ. 200VAC/common)	-	○	
External connection system		20-point terminal block connector (M3.5×7 screws)	18-point terminal block (M3×6 screws)	×	Wiring change is required.
Applicable wire size		0.75 to 1.25mm ²	Core: 0.3 to 0.75mm ² (outside diameter: 2.8mm (0.11 inches) or less)	×	
Applicable solderless terminal		R1.25-3.5, R2-3.5, RAV1.25-3.5, RAV2-3.5	R1.25-3 (Sleeved solderless terminal cannot be used.)	×	
Current consumption		0.27A (typ. all points on)	0.25A (MAX. all points on)	○	
External dimensions		130(H)×34.5(W)×93.6(D)mm	98(H)×27.4(W)×112.3(D)mm	△	Wiring space is narrower.
Weight		0.24kg	0.40kg	△	The weight is increased.

*1 Connect a fuse to every external terminal to prevent the external device and module at load short from burnout. Also, configure an external circuit if fuse blown indication is required.

(7) Specifications comparison between A1SY40 and QY40P

○: Compatible, △: Partially changed, ×: Incompatible

Specifications		A1SY40	QY40P	Compatibility	Precautions for replacement
Number of output points		16 points	16 points	○	
Isolation method		Photocoupler	Photocoupler	○	
Rated load voltage		12/24VDC	12/24VDC	○	
Operating load voltage range		10.2-30VDC (peak voltage 30VDC)	10.2-28.8VDC	△	Voltage exceeding 28.8VDC is not applicable.
Maximum load current		0.1A/point, 0.8A/common	0.1A/point, 1.6A/common	○	
Maximum inrush current		0.4A 10ms or less	0.7A 10ms or less	○	
Leakage current at off		0.1mA or less	0.1mA or less	○	
Maximum voltage drop at on		1.0VDC (typ.) 0.1A 2.5VDC (MAX.) 0.1A	0.1VDC (typ.) 0.1A 0.2VDC (MAX.) 0.1A	○	
Response time	Off → on	2ms or less	1ms or less	○	
	On → off	2ms or less (resistance load)	1ms or less (rated load, resistance load)	○	
Surge suppressor		Zener diode	Zener diode	○	
Common terminal arrangement		8 points/common (common terminal: TB10, TB20)	16 points/common (common terminal: TB18)	△	As the common is changed from 2 commons to 1 common, wiring with a different voltage for each common is not possible.
Operation indication		On indication (LED)	On indication (LED)	○	
Fuse rating (breaking capacity)		1.6A (1 fuse/common) Cannot be changed. (breaking capacity: 50A)	-	-	These specifications are changed to the protection function.
Fuse blown indication		Available (LED turns on when a fuse is blown and a signal is output to the CPU module.)	-	-	
Protection function		-	Available (overheat protection function, overload protection function) • The overheat protection function is activated in increments of 1 point. • The overload protection function is activated in increments of 1 point.	○	
External power supply	Voltage	12/24VDC (10.2 to 30VDC)	12-24VDC (10.2 to 28.8VDC ripple ratio within 5%)	△	Voltage exceeding 28.8VDC is not applicable.
	Current	8mA (typ. 24VDC for one common)	MAX. 10mA (24VDC) (all points on)	○	
External connection system		20-point terminal block connector (M3.5×7 screws)	18-point terminal block (M3×6 screws)	×	Wiring change is required.
Applicable wire size		0.75 to 1.5mm ²	Core: 0.3 to 0.75mm ² (outside diameter: 2.8mm (0.11 inches) or less)	×	
Applicable solderless terminal		R1.25-3.5, R2-3.5, RAV1.25-3.5, RAV2-3.5	R1.25-3 (Sleeved solderless terminal cannot be used.)	×	
Current consumption		0.27A (typ. all points on)	0.065A (typ. all points on)	○	
External dimensions		130(H)×34.5(W)×93.6(D)mm	98(H)×27.4(W)×90(D)mm	△	Wiring space is narrower.
Weight		0.19kg	0.16kg	○	

(8) Specifications comparison between A1SY40P and QY40P

○: Compatible, △: Partially changed, ×: Incompatible

Specifications		A1SY40P	QY40P	Compat- ibility	Precautions for replacement
Number of output points		16 points	16 points	○	
Isolation method		Photocoupler	Photocoupler	○	
Rated load voltage		12/24VDC	12/24VDC	○	
Operating load voltage range		10.2-30VDC (peak voltage 30VDC)	10.2-28.8VDC	△	Voltage exceeding 28.8VDC is not applicable.
Maximum load current		0.1A/point, 0.8A/common	0.1A/point, 1.6A/common	○	
Maximum inrush current		0.7A 10ms or less	0.7A 10ms or less	○	
Leakage current at off		0.1mA or less	0.1mA or less	○	
Maximum voltage drop at on		0.1VDC (typ.) 0.1A 0.2VDC (MAX.) 0.1A	0.1VDC (typ.) 0.1A 0.2VDC (MAX.) 0.1A	○	
Response time	Off → on	1ms or less	1ms or less	○	
	On → off	1ms or less (rated load, resistance load)	1ms or less (rated load, resistance load)	○	
Surge suppressor		Zener diode	Zener diode	○	
Common terminal arrangement		8 points/common (common terminal: TB10, TB20)	16 points/common (common terminal: TB18)	△	As the common is changed from 2 commons to 1 common, wiring with a different voltage for each common is not possible.
Operation indication		On indication (LED)	On indication (LED)	○	
Protection function		Available (overheat protection function, overload protection function) • The overheat protection function is activated in increments of 1 point. • The overload protection function is activated in increments of 1 point.	Available (overheat protection function, overload protection function) • The overheat protection function is activated in increments of 1 point. • The overload protection function is activated in increments of 1 point.	○	
External power supply	Voltage	12/24VDC (10.2 to 30VDC)	12-24VDC (10.2 to 28.8VDC ripple ratio within 5%)	△	Voltage exceeding 28.8VDC is not applicable.
	Current	11mA (typ. 24VDC for each common)	MAX.10mA (24VDC) (all points on)	○	
External connection system		20-point terminal block connector (M3.5×7 screws)	18-point terminal block (M3×6 screws)	×	Wiring change is required.
Applicable wire size		0.75 to 1.5mm ²	Core: 0.3 to 0.75mm ² (outside diameter: 2.8mm (0.11 inches) or less)	×	
Applicable solderless terminal		R1.25-3.5, R2-3.5, RAV1.25-3.5, RAV2-3.5	R1.25-3 (Sleeved solderless terminal cannot be used.)	×	
Current consumption		0.079A (typ. all points on)	0.065A (typ. all points on)	○	
External dimensions		130(H)×34.5(W)×93.6(D)mm	98(H)×27.4(W)×90(D)mm	△	Wiring space is narrower.
Weight		0.13kg	0.16kg	△	The weight is increased.

(9) Specifications comparison between A1SY41 and QY41P

○: Compatible, △: Partially changed, ×: Incompatible

Specifications		A1SY41	QY41P	Compat- ibility	Precautions for replacement
Number of output points		32 points	32 points	○	
Isolation method		Photocoupler	Photocoupler	○	
Rated load voltage		12/24VDC	12-24VDC	○	
Operating load voltage range		10.2 to 30VDC (peak voltage 30VDC)	10.2 to 28.8VDC	△	Voltage exceeding 28.8VDC is not applicable.
Maximum load current		0.1A/point 2A/common	0.1A/point 2A/common	○	
Maximum inrush current		0.4A 10ms or less	0.7A 10ms or less	○	
Leakage current at off		0.1mA or less	0.1mA or less	○	
Maximum voltage drop at on		1.0VDC (typ.) 0.1A 2.5VDC (MAX.) 0.1A	0.1VDC (typ.) 0.1A 0.2VDC (MAX.) 0.1A	○	
Response time	Off → on	2ms or less	1ms or less	○	
	On → off	2ms or less (resistance load)	1ms or less (rated load, resistance load)	○	
Surge suppressor		Zener diode	Zener diode	○	
Common terminal arrangement		32 points/common (common terminal: A1, A2)	32 points/common (common terminal: A01, A02)	○	
Operation indication		On indication (LED)	On indication (LED)	○	
Fuse rating (breaking capacity)		3.2A (1 fuse/common) Cannot be changed. (breaking capacity: 50A)	-	-	These specifications are changed to the protection function.
Fuse blown indication		Available (LED turns on when a fuse is blown and a signal is output to the CPU module.)	-	-	
Protection function		-	Available (overheat protection function, overload protection function) • The overheat protection function is activated in increments of 1 point. • The overload protection function is activated in increments of 1 point.	○	
External power supply	Voltage	12/24VDC (10.2 to 30VDC)	12-24VDC (10.2 to 28.8VDC ripple ratio within 5%)	△	Voltage exceeding 28.8VDC is not applicable.
	Current	8mA (typ. 24VDC for each common)	20mA (24VDC)	△	The current value is increased.
External connection system		40-pin connector (accessory)	40-pin connector (sold separately)	○	Existing external wiring can be used.
Applicable wire size		0.3mm ²	0.3mm ² (A6CON1, A6CON4)	○	
Current consumption		0.500A (typ. all points on)	0.105A (typ. all points on)	○	
External dimensions		130(H)×34.5(W)×93.6(D)mm	98(H)×27.4(W)×90(D)mm	○	
Weight		0.21kg	0.15kg	○	

(10) Specifications comparison between A1SY41P and QY41P

○: Compatible, △: Partially changed, ×: Incompatible

Specifications		A1SY41P	QY41P	Compat- ibility	Precautions for replacement
Number of output points		32 points	32 points	○	
Isolation method		Photocoupler	Photocoupler	○	
Rated load voltage		12/24VDC	12-24VDC	○	
Operating load voltage range		10.2 to 30VDC (peak voltage 30VDC)	10.2 to 28.8VDC	△	Voltage exceeding 28.8VDC is not applicable.
Maximum load current		0.1A/point 2A/common	0.1A/point 2A/common	○	
Maximum inrush current		0.7A 10ms or less	0.7A 10ms or less	○	
Leakage current at off		0.1mA or less	0.1mA or less	○	
Maximum voltage drop at on		0.1VDC (typ.) 0.1A 0.2VDC (MAX.) 0.1A	0.1VDC (typ.) 0.1A 0.2VDC (MAX.) 0.1A	○	
Response time	Off → on	1ms or less	1ms or less	○	
	On → off	1ms or less (rated load, resistance load)	1ms or less (rated load, resistance load)	○	
Surge suppressor		Zener diode	Zener diode	○	
Common terminal arrangement		32 points/common (common terminal: A1, A2)	32 points/common (common terminal: A01, A02)	○	
Operation indication		On indication (LED)	On indication (LED)	○	
Protection function		Available (overheat protection function, overload protection function) • The overheat protection function is activated in increments of 1 point. • The overload protection function is activated in increments of 1 point.	Available (overheat protection function, overload protection function) • The overheat protection function is activated in increments of 1 point. • The overload protection function is activated in increments of 1 point.	○	
External power supply	Voltage	12/24VDC (10.2 to 30VDC)	12-24VDC (10.2 to 28.8VDC ripple ratio within 5%)	△	Voltage exceeding 28.8VDC is not applicable.
	Current	12mA (typ. 24VDC for each common)	20mA (24VDC)	△	The current value is increased.
External connection system		40-pin connector (accessory)	40-pin connector (sold separately)	○	Existing external wiring can be used.
Applicable wire size		0.3mm ²	0.3mm ² (A6CON1, A6CON4)	○	
Current consumption		0.141A (typ. all points on)	0.105A (typ. all points on)	○	
External dimensions		130(H)×34.5(W)×93.6(D)mm	98(H)×27.4(W)×90(D)mm	○	
Weight		0.15kg	0.15kg	○	

(11) Specifications comparison between A1SY42 and QY42P

○: Compatible, △: Partially changed, ×: Incompatible

Specifications		A1SY42	QY42P	Compat- ibility	Precautions for replacement
Number of output points		64 points	64 points	○	
Isolation method		Photocoupler	Photocoupler	○	
Rated load voltage		12/24VDC	12-24VDC	○	
Operating load voltage range		10.2 to 30VDC (peak voltage 30VDC)	10.2 to 28.8VDC	△	Voltage exceeding 28.8VDC is not applicable.
Maximum load current		0.1A/point, 1.6A/common	0.1A/point, 2A/common	○	
Maximum inrush current		0.4A 10ms or less	0.7A 10ms or less	○	
Leakage current at off		0.1mA or less	0.1mA or less	○	
Maximum voltage drop at on		1.0VDC (typ.) 0.1A 2.5VDC (MAX.) 0.1A	0.1VDC (typ.) 0.1A 0.2VDC (MAX.) 0.1A	○	
Response time	Off → on	2ms or less	1ms or less	○	
	On → off	2ms or less (resistance load)	1ms or less (rated load, resistance load)	○	
Surge suppressor		Zener diode	Zener diode	○	
Common terminal arrangement		32 points/common (common terminal: 1A1, 1A2, 2A1, 2A2)	32 points/common (common terminal: 1A01, 1A02, 2A01, 2A02)	○	
Operation indication		On indication (LED) 32-point switching indication with the switch	On indication (LED) 32-point switching indication with the switch	○	
Fuse rating (breaking capacity)		3.2A (1 fuse/common) Cannot be changed. (breaking capacity: 50A)	-	-	These specifications are changed to the protection function.
Fuse blown indication		Available (LED turns on when a fuse is blown and a signal is output to the CPU module.)	-	-	
Protection function		-	Available (overheat protection function, overload protection function) • The overheat protection function is activated in increments of 1 point. • The overload protection function is activated in increments of 1 point.	○	
External power supply	Voltage	12/24VDC (10.2 to 30VDC)	12-24VDC (10.2 to 28.8VDC) (ripple ratio within 5%)	△	Voltage exceeding 28.8VDC is not applicable.
	Current	8mA (typ. 24VDC for each common)	20mA (24VDC)/common	△	The current value is increased.
External connection system		40-pin connector 2 pieces (accessory)	40-pin connector 2 pieces (sold separately)	○	Existing external wiring can be used.
Applicable wire size		0.3mm ²	0.3mm ² (A6CON1, A6CON4)	○	
Current consumption		0.93A (typ. all points on)	0.15A (typ. all points on)	○	
External dimensions		130(H)×34.5(W)×93.6(D)mm	98(H)×27.4(W)×90(D)mm	○	
Weight		0.27kg	0.17kg	○	

(12) Specifications comparison between A1SY42P and QY42P

○: Compatible, △: Partially changed, ×: Incompatible

Specifications		A1SY42P	QY42P	Compat- ibility	Precautions for replacement
Number of output points		64 points	64 points	○	
Isolation method		Photocoupler	Photocoupler	○	
Rated load voltage		12/24VDC	12-24VDC	○	
Operating load voltage range		10.2 to 30VDC (peak voltage 30VDC)	10.2 to 28.8VDC	△	Voltage exceeding 28.8VDC is not applicable.
Maximum load current		0.1A/point, 2A/common	0.1A/point, 2A/common	○	
Maximum inrush current		0.7A 10ms or less	0.7A 10ms or less	○	
Leakage current at off		0.1mA or less	0.1mA or less	○	
Maximum voltage drop at on		0.1VDC (typ.) 0.1A 0.2VDC (MAX.) 0.1A	0.1VDC (typ.) 0.1A 0.2VDC (MAX.) 0.1A	○	
Response time	Off → on	1ms or less	1ms or less	○	
	On → off	1ms or less (rated load, resistance load)	1ms or less (rated load, resistance load)	○	
Surge suppressor		Zener diode	Zener diode	○	
Common terminal arrangement		32 points/common (common terminal: 1A1, 1A2, 2A1, 2A2)	32 points/common (common terminal: 1A01, 1A02, 2A01, 2A02)	○	
Operation indication		On indication (LED) 32-point switching indication with the switch	On indication (LED) 32-point switching indication with the switch	○	
Protection function		Available (overheat protection function, overload protection function) • The overheat protection function is activated in increments of 1 point. • The overload protection function is activated in increments of 1 point.	Available (overheat protection function, overload protection function) • The overheat protection function is activated in increments of 1 point. • The overload protection function is activated in increments of 1 point.	○	
External power supply	Voltage	12/24VDC (10.2 to 30VDC)	12-24VDC (10.2 to 28.8VDC) (ripple ratio within 5%)	△	Voltage exceeding 28.8VDC is not applicable.
	Current	14mA (typ. 24VDC for each common)	20mA (24VDC)/common	△	The current value is increased.
External connection system		40-pin connector 2 pieces (accessory)	40-pin connector 2 pieces (sold separately)	○	Existing external wiring can be used.
Applicable wire size		0.3mm ²	0.3mm ² (A6CON1, A6CON4)	○	
Current consumption		0.17A (typ. all points on)	0.15A (typ. all points on)	○	
External dimensions		130(H)×34.5(W)×93.6(D)mm	98(H)×27.4(W)×90(D)mm	○	
Weight		0.17kg	0.17kg	○	

(13) Specifications comparison between A1SY50 and QY50

○: Compatible, △: Partially changed, ×: Incompatible

Specifications		A1SY50	QY50	Compatibility	Precautions for replacement
Number of output points		16 points	16 points	○	
Isolation method		Photocoupler	Photocoupler	○	
Rated load voltage		12/24VDC	12/24VDC	○	
Operating load voltage range		10.2 to 30VDC (peak voltage 30VDC)	10.2 to 28.8VDC	△	Voltage exceeding 28.8VDC is not applicable.
Maximum load current		0.5A/point, 2A/common	0.5A/point, 4A/common	○	
Maximum inrush current		4A 10ms or less	4A 10ms or less	○	
Leakage current at off		0.1mA or less	0.1mA or less	○	
Maximum voltage drop at on		0.9VDC (typ.) 0.5A 1.5VDC (MAX.) 0.5A	0.2VDC (typ.) 0.5A 0.3VDC (MAX.) 0.5A	○	
Response time	Off → on	2ms or less	1ms or less	○	
	On → off	2ms or less (resistance load)	1ms or less (rated load, resistance load)	○	
Surge suppressor		Zener diode	Zener diode	○	
Common terminal arrangement		8 points/common (common terminal: TB10, TB20)	16 points/common (common terminal: TB18)	△	As the common is changed from 2 commons to 1 common, wiring with a different voltage for each common is not possible.
Operation indication		On indication (LED)	On indication (LED)	○	
Fuse rating (breaking capacity)		3.2A (1 fuse/common) Cannot be changed. (breaking capacity: 50A)	6.7A Cannot be changed. (breaking capacity: 50A)	○	
Fuse blown indication		Available (LED turns on when a fuse is blown and a signal is output to the CPU module.)	Available (LED turns on when a fuse is blown and a signal is output to the CPU module.)	○	
External power supply	Voltage	12/24VDC (10.2 to 30VDC)	12/24VDC (10.2 to 28.8VDC) (ripple ratio within 5%)	△	Voltage exceeding 28.8VDC is not applicable.
	Current	60mA (typ. 24VDC for each common)	20mA (24VDC)	○	
External connection system		20-point terminal block connector (M3.5×7 screws)	18-point terminal block (M3×6 screws)	×	Wiring change is required.
Applicable wire size		0.75 to 1.25mm ²	Core: 0.3 to 0.75mm ² (outside diameter: 2.8mm (0.11 inches) or less)	×	
Applicable solderless terminal		R1.25-3.5, R2-3.5, RAV1.25-3.5, RAV2-3.5	R1.25-3 (Sleeved solderless terminal cannot be used.)	×	
Current consumption		0.12A (typ. all points on)	0.08A (typ. all points on)	○	
External dimensions		130(H)×34.5(W)×93.6(D)mm	98(H)×27.4(W)×90(D)mm	△	Wiring space is narrower.
Weight		0.20kg	0.17kg	○	

(14) Specifications comparison between A1SY60 and QY68A

○: Compatible, △: Partially changed, ×: Incompatible

Specifications		A1SY60	QY68A	Compat- ibility	Precautions for replacement
Number of output points		16 points	8 points (16 points occupied)	△	When 9 or more points are used, use two QY68A modules.
Isolation method		Photocoupler	Photocoupler	○	
Rated load voltage		24VDC	5-24VDC	○	
Operating load voltage range		21.6 to 26.4VDC (peak voltage 26.4VDC)	4.5 to 28.8VDC	○	
Maximum load current		2A/point, 4A/common (25°C), 1.8A/point, 3.6A/common (45°C), 1.6A/point, 3.2A/common (55°C)	2A/point, 8A/module	△	The load current must be 8A or less within a module.
Maximum inrush current		8A 10ms or less	8A 10ms or less	○	
Leakage current at off		0.1mA or less	0.1mA or less	○	
Maximum voltage drop at on		0.9VDC (typ.) 2A, 1.5VDC (MAX.) 0.5A	0.3VDC (MAX.) 2A	○	
Response time	Off → on	2ms or less	3ms or less	△	The response time differs.
	On → off	2ms or less (resistance load)	10ms or less (resistance load)	△	
Surge suppressor		Zener diode	Zener diode	○	
Common terminal arrangement		8 points/common (common terminal: TB10, TB20)	All points independent common	△	Wiring of the terminal block needs to be changed because all terminals become independent.
Operation indication		On indication (LED)	On indication (LED)	○	
Fuse rating (breaking capacity)		5A (1 fuse/common) Cannot be changed. (breaking capacity: 50A)	None (Connecting a fuse to external wiring is recommended.)	×	Fuses are not built in.*1
Fuse blown indication		Available (LED turns on when a fuse is blown and a signal is output to the CPU module.)			
External power supply	Voltage	24VDC (21.6 to 26.4VDC)	-	○	An external power supply is not required.
	Current	15mA (typ. 24VDC for each common)	-	○	
External connection system		20-point terminal block connector (M3.5×7 screws)	18-point terminal block (M3×6 screws)	×	Wiring change is required.
Applicable wire size		0.75 to 1.25mm ²	Core: 0.3 to 0.75mm ² (outside diameter: 2.8mm (0.11 inches) or less)	×	
Applicable solderless terminal		R1.25-3.5, R2-3.5, RAV1.25-3.5, RAV2-3.5	R1.25-3 (Sleeved solderless terminal cannot be used.)	×	
Current consumption		0.12A (typ. all points on)	0.11A (typ. all points on)	△	When two QY68A modules are used, the current consumption is increased. Review the current capacity.
External dimensions		130(H)×34.5(W)×93.6(D)mm	98(H)×27.4(W)×90(D)mm	△	Wiring space is narrower.
Weight		0.25kg	0.14kg	○	

*1 Connect a fuse to every external terminal to prevent the external device and module at load short from burnout. Also, configure an external circuit if fuse blown indication is required.

(15) Specifications comparison between A1SY60E and QY68A

○: Compatible, △: Partially changed, ×: Incompatible

Specifications		A1SY60E	QY68A	Compatibility	Precautions for replacement
Number of output points		16 points	8 points (16 points occupied)	△	When 9 or more points are used, use two QY68A modules.
Isolation method		Photocoupler	Photocoupler	○	
Rated load voltage		5/12/24VDC	5-24VDC	○	
Operating load voltage range		4.5 to 26.4VDC (peak voltage 26.4VDC)	4.5 to 28.8VDC	○	
Maximum load current		2A/point (condition: $T=L/R \leq 2.5\text{ms}$), 4A/common	2A/point 8A/module	○	
Maximum inrush current		8A 10ms or less	8A 10ms or less	○	
Leakage current at off		0.1mA or less	0.1mA or less	○	
Maximum voltage drop at on		0.2VDC (MAX.) 1A, 0.4VDC (MAX.) 2A	0.3VDC (MAX.) 2A	○	
Response time	Off → on	3ms or less	3ms or less	○	
	On → off	10ms or less (resistance load)	10ms or less (resistance load)	○	
Surge suppressor		Zener diode	Zener diode	○	
Common terminal arrangement		8 points/common (common terminal: TB9, TB19)	All points independent common	△	Wiring of the terminal block needs to be changed because all terminals become independent.
Operation indication		On indication (LED)	On indication (LED)	○	
Fuse rating (breaking capacity)		7A (1 fuse/common) Cannot be changed. (breaking capacity: 300A)	None (Connecting a fuse to external wiring is recommended.)	×	Fuses are not built in.*1
Fuse blown indication		Available (LED turns on when a fuse is blown and a signal is output to the CPU module.)			
External power supply	Voltage	12/24VDC (10.2 to 26.4VDC)	-	○	An external power supply is not required.
	Current	10mA (typ. 24VDC for each common)	-	○	
External connection system		20-point terminal block connector (M3.5×7 screws)	18-point terminal block (M3×6 screws)	×	Wiring change is required.
Applicable wire size		0.75 to 1.25mm ²	Core: 0.3 to 0.75mm ² (outside diameter: 2.8mm (0.11 inches) or less)	×	
Applicable solderless terminal		R1.25-3.5, R2-3.5, RAV1.25-3.5, RAV2-3.5	R1.25-3 (Sleeved solderless terminal cannot be used.)	×	
Current consumption		0.20A (typ. all points on)	0.11A (typ. all points on)	△	When two QY68A modules are used, the current consumption is increased. Review the current capacity.
External dimensions		130(H)×34.5(W)×93.6(D)mm	98(H)×27.4(W)×90(D)mm	△	Wiring space is narrower.
Weight		0.20kg	0.14kg	○	

*1 Connect a fuse to every external terminal to prevent the external device and module at load short from burnout. Also, configure an external circuit if fuse blown indication is required.

(16) Specifications comparison between A1SY68A and QY68A

○: Compatible, △: Partially changed, ×: Incompatible

Specifications		A1SY68A	QY68A	Compat- ibility	Precautions for replacement
Number of output points		8 points (16 points occupied)	8 points (16 points occupied)	○	
Isolation method		Photocoupler	Photocoupler	○	
Rated load voltage		5/12/24/48VDC	5-24VDC	△	48VDC is not applicable.
Operating load voltage range		4.5 to 52.8VDC	4.5 to 28.8VDC	△	Voltage exceeding 28.8VDC is not applicable.
Maximum load current		2A/point	2A/point, 8A/module	△	The load current must be 8A or less within a module.
Maximum inrush current		8A 10ms or less	8A 10ms or less	○	
Leakage current at off		0.1mA or less	0.1mA or less	○	
Maximum voltage drop at on		0.4VDC (MAX.) 2A	0.3VDC (MAX.) 2A	○	
Response time	Off → on	3ms or less	3ms or less	○	
	On → off	10ms or less (resistance load)	10ms or less (resistance load)	○	
Surge suppressor		Zener diode	Zener diode	○	
Common terminal arrangement		All points independent common	All points independent common	○	
Operation indication		On indication (LED)	On indication (LED)	○	
Fuse		None	None	-	
External connection system		20-point terminal block connector (M3.5×7 screws)	18-point terminal block (M3×6 screws)	×	Wiring change is required.
Applicable wire size		0.75 to 1.25mm ²	Core: 0.3 to 0.75mm ² (outside diameter: 2.8mm (0.11 inches) or less)	×	
Applicable solderless terminal		R1.25-3.5, R2-3.5, RAV1.25-3.5, RAV2-3.5	R1.25-3 (Sleeved solderless terminal cannot be used.)	×	
Current consumption		0.11A (typ. all points on)	0.11A (typ. all points on)	○	
External dimensions		130(H)×34.5(W)×93.6(D)mm	98(H)×27.4(W)×90(D)mm	△	Wiring space is narrower.
Weight		0.20kg	0.14kg	○	

(17) Specifications comparison between A1SY71 and QY71

○: Compatible, △: Partially changed, ×: Incompatible

Specifications		A1SY71	QY71	Compat- ibility	Precautions for replacement
Number of output points		32 points	32 points	○	
Isolation method		Photocoupler	Photocoupler	○	
Rated load voltage		5/12VDC	5/12VDC	○	
Operating load voltage range		4.5 to 15VDC	4.5 to 15VDC	○	
Maximum load current		16mA/point 256mA/common	16mA/point 512mA/common	○	
Maximum inrush current		40mA 10ms or less	40mA 10ms or less	○	
Output voltage at off		V _{OH} : 3.5VDC (V _{CC} = 5VDC, I _{OH} = 0.4mA)	V _{OH} : 3.5VDC (V _{CC} = 5VDC, I _{OH} = 0.4mA)	○	
Maximum voltage drop at on		V _{OL} : 0.3VDC	V _{OL} : 0.3VDC	○	
Response time	Off → on	1ms or less	0.5ms or less	○	
	On → off	1ms or less (resistance load)	0.5ms or less (resistance load)	○	
Common terminal arrangement		32 points/common (common terminal: A1, A2)	32 points/common (common terminal: A01, A02)	○	
Operation indication		On indication (LED)	On indication (LED)	○	
Fuse rating (breaking capacity)		1.6A Cannot be changed. (breaking capacity: 50A)	1.6A Cannot be changed. (breaking capacity: 50A)	○	
Fuse blown indication		Available (LED turns on when a fuse is blown and a signal is output to the CPU module.)	Available (LED turns on when a fuse is blown and a signal is output to the CPU module.)	○	
External power supply	Voltage	5/12VDC (4.5 to 15VDC)	5/12VDC (4.5 to 15VDC) (ripple ratio within 5%)	○	
	Current	150mA (typ. 12VDC for each common)	Max.170mA (12VDC, all points on)	△	The current value is increased.
External connection system		40-pin connector (accessory)	40-pin connector (sold separately)	○	Existing external wiring can be used.
Applicable wire size		0.3mm ²	0.3mm ² (A6CON1, A6CON4)	○	
Current consumption		0.40A (typ. all points on)	0.15A (typ. all points on)	○	
External dimensions		130(H)×34.5(W)×93.6(D)mm	98(H)×27.4(W)×90(D)mm	○	
Weight		0.19kg	0.14kg	○	

(18) Specifications comparison between A1SY80 and QY80

○: Compatible, △: Partially changed, ×: Incompatible

Specifications		A1SY80	QY80	Compat- ibility	Precautions for replacement
Number of output points		16 points	16 points	○	
Isolation method		Photocoupler	Photocoupler	○	
Rated load voltage		12/24VDC	12/24VDC	○	
Operating load voltage range		10.2 to 30VDC (peak voltage 30VDC)	10.2 to 28.8VDC	△	Voltage exceeding 28.8VDC is not applicable.
Maximum load current		0.8A/point, 3.2A/common	0.5A/point, 4A/common	△	Carefully select load for use since the maximum load current per point is lowered.
Maximum inrush current		8A 10ms or less	4A 10ms or less	△	Carefully select a load for use since the minimum load current is increased.
Leakage current at off		0.1mA or less	0.1mA or less	○	
Maximum voltage drop at on		1.5VDC (MAX.) 0.8A	0.2VDC (typ.) 0.5A 0.3VDC (MAX.) 0.5A	○	
Response time	Off → on	2ms or less	1ms or less	○	
	On → off	2ms or less (resistance load)	1ms or less (rated load, resistance load)	○	
Surge suppressor		Zener diode	Zener diode	○	
Common terminal arrangement		8 points/common (common terminal: TB9, TB19)	16 points/common (common terminal: TB17)	△	As the common is changed from 2 commons to 1 common, wiring with a different voltage for each common is not possible.
Operation indication		On indication (LED)	On indication (LED)	○	
Fuse rating (breaking capacity)		5A (1 fuse/common) Cannot be changed. (breaking capacity: 50A)	6.7A Cannot be changed. (breaking capacity: 50A)	○	
Fuse blown indication		Available (LED turns on when a fuse is blown and a signal is output to the CPU module.)	Available (LED turns on when a fuse is blown and a signal is output to the CPU module.)	○	
External power supply	Voltage	12/24VDC (10.2 to 30VDC)	12/24VDC (10.2 to 28.8VDC) (ripple ratio within 5%)	△	Voltage exceeding 28.8VDC is not applicable.
	Current	20mA (typ. 24VDC for each common)	20mA (24VDC)	○	
External connection system		20-point terminal block connector (M3.5×7 screws)	18-point terminal block (M3×6 screws)	×	Wiring change is required.
Applicable wire size		0.75 to 1.25mm ²	Core: 0.3 to 0.75mm ² (outside diameter: 2.8mm (0.11 inches) or less)	×	
Applicable solderless terminal		R1.25-3.5, R2-3.5, RAV1.25-3.5, RAV2-3.5	R1.25-3 (Sleeved solderless terminal cannot be used.)	×	
Current consumption		0.12A (typ. all points on)	0.08A (typ. all points on)	○	
External dimensions		130(H)×34.5(W)×93.6(D)mm	98(H)×27.4(W)×90(D)mm	△	Wiring space is narrower.
Weight		0.20kg	0.17kg	○	

(19) Specifications comparison between A1SY81 and QY81P

○: Compatible, △: Partially changed, ×: Incompatible

Specifications		A1SY81	QY81P	Compat- ibility	Precautions for replacement
Number of output points		32 points	32 points	○	
Isolation method		Photocoupler	Photocoupler	○	
Rated load voltage		12/24VDC	12-24VDC (+20/-15%)	○	
Operating load voltage range		10.2 to 30VDC	10.2 to 28.8VDC	△	Voltage exceeding 28.8VDC is not applicable.
Maximum load current		0.1A/point, 2A/common	0.1A/point, 2A/common	○	
Maximum inrush current		0.4A 10ms or less	0.7A 10ms or less	○	
Leakage current at off		0.1mA or less	0.1mA or less	○	
Maximum voltage drop at on		1.0VDC (typ.) 0.1A 2.5VDC (MAX.) 0.1A	0.1VDC (typ.) 0.1A 0.2VDC (MAX.) 0.1A	○	
Response time	Off → on	2ms or less	1ms or less	○	
	On → off	2ms or less (resistance load)	1ms or less (rated load, resistance load)	○	
Surge suppressor		Zener diode	Zener diode	○	
Common terminal arrangement		32 points/common (common terminal: 17, 18, 36)	32 points/common (common terminal: 17, 18, 36)	○	
Operation indication		On indication (LED)	On indication (LED)	○	
Fuse rating (breaking capacity)		3.2A Cannot be changed. (breaking capacity: 50A)			These specifications are changed to the protection function.
Fuse blown indication		Available (LED turns on when a fuse is blown and a signal is output to the CPU module.)	-	-	
Protection function		-	Available (overheat protection function, overload protection function) • The overheat protection function is activated in increments of 2 points. • The overload protection function is activated in increments of 1 point.	○	
External power supply	Voltage	12/24VDC (10.2 to 30VDC)	12-24VDC (10.2 to 28.8VDC) (ripple ratio within 5%)	△	Voltage exceeding 28.8VDC is not applicable.
	Current	8mA (TYP.24VDC for each common)	40mA (24VDC)	△	The current value is increased.
External connection system		37-pin D-sub connector (accessory)	37-pin D-sub connector (sold separately)	○	Existing external wiring can be used.
Applicable wire size		0.3mm ²	0.3mm ² (A6CON1E)	○	Note that the connecting direction of the connector is inverted.
Current consumption		0.50A (typ. all points on)	0.095A (typ. all points on)	○	
External dimensions		130(H)×34.5(W)×93.6(D)mm	98(H)×27.4(W)×90(D)mm	○	
Weight		0.23kg	0.15kg	○	

(20) Specifications comparison between A1SY81EP and QY81P

○: Compatible, △: Partially changed, ×: Incompatible

Specifications		A1SY81EP	QY81P	Compat- ibility	Precautions for replacement
Number of output points		32 points	32 points	○	
Isolation method		Photocoupler	Photocoupler	○	
Rated load voltage		12/24VDC	12-24VDC	○	
Operating load voltage range		10.2 to 26.4VDC	10.2 to 28.8VDC	○	
Maximum load current		0.1A/point, 2A/common (25°C), 0.05A/point, 1.6A/common (55°C)	0.1A/point, 2A/common	○	
Maximum inrush current		No limit (overload protection function)	0.7A 10ms or less	△	Check the specification of the device to be connected.
Leakage current at off		0.1mA or less	0.1mA or less	○	
Maximum voltage drop at on		3.5VDC (0.1A Max.), 2.5VDC (0.1A Min.)	0.1VDC (typ.) 0.1A 0.2VDC (MAX.) 0.1A	○	
Response time	Off → on	0.5ms or less	1ms or less	△	The response speed is slower.
	On → off	1.5ms or less (resistance load)	1ms or less (rated load, resistance load)	○	
Surge suppressor		Clamp diode	Zener diode	○	
Common terminal arrangement		32 points/common (common terminal: 17, 18, 36)	32 points/common (common terminal: 17, 18, 36)	○	
Operation indication		On indication (LED)	On indication (LED)	○	
Protection function		Available (overheat protection function, overload protection function) • The overheat protection function is activated in increments of 8 points. • If the function is activated even for 1 point within the range of 8 points, outputs of all 8 points are turned off.	Available (overheat protection function, overload protection function) • The overheat protection function is activated in increments of 2 points. • The overload protection function is activated in increments of 1 point.	○	
External power supply	Voltage	12/24VDC (10.2 to 26.4VDC)	12-24VDC (10.2 to 28.8VDC) (ripple ratio within 5%)	○	
	Current	80mA (typ. 24VDC for each common)	40mA (24VDC)	○	
External connection system		37-pin D-sub connector (accessory)	37-pin D-sub connector (sold separately)	○	Existing external wiring can be used.
Applicable wire size		0.3mm ²	0.3mm ² (A6CON1E)	○	Note that the connecting direction of the connector is inverted.
Current consumption		0.50A (typ. all points on)	0.095A (typ. all points on)	○	
External dimensions		130(H)×34.5(W)×93.6(D)mm	98(H)×27.4(W)×90(D)mm	○	
Weight		0.25kg	0.15kg	○	

(21) Specifications comparison between A1SY82 and QY82P

○: Compatible, △: Partially changed, ×: Incompatible

Specifications		A1SY82	QY82P	Compat- ibility	Precautions for replacement
Number of output points		64 points	64 points	○	
Isolation method		Photocoupler	Photocoupler	○	
Rated load voltage		12/24VDC	12/24VDC	○	
Operating load voltage range		10.2 to 30VDC	10.2 to 28.8VDC	△	Voltage exceeding 28.8VDC is not applicable.
Maximum load current		0.1A/point, 1.6A/common	0.1A/point, 2A/common	○	
Maximum inrush current		0.4A 10ms or less	0.7A 10ms or less	○	
Leakage current at off		0.1mA or less	0.1mA or less	○	
Maximum voltage drop at on		1.0VDC (typ.) 0.1A 2.5VDC (MAX.) 0.1A	0.1VDC (typ.) 0.1A 0.2VDC (MAX.) 0.1A	○	
Response time	Off → on	2ms or less	1ms or less	○	
	On → off	2ms or less (resistance load)	1ms or less (rated load, resistance load)	○	
Surge suppressor		Zener diode	Zener diode	○	
Common terminal arrangement		32 points/common (common terminal: 1B1, 1B2, 2B1, 2B2)	32 points/common (common terminal: 1B1, 1B2, 2B1, 2B2)	○	
Operation indication		On indication (LED) 32-point switching indication with the switch	On indication (LED) 32-point switching indication with the switch	○	
Fuse rating (breaking capacity)		3.2A (1 fuse/common) Cannot be changed. (breaking capacity: 50A)	-	-	These specifications are changed to the protection function.
Fuse blown indication		Available (LED turns on when a fuse is blown and a signal is output to the CPU module.)	-	-	
Protection function		-	Available (overheat protection function, overload protection function) • The overheat protection function is activated in increments of 2 points. • The overload protection function is activated in increments of 1 point.	○	
External power supply	Voltage	12/24VDC (10.2 to 30VDC)	12/24VDC (10.2 to 28.8VDC) (ripple ratio within 5%)	△	Voltage exceeding 28.8VDC is not applicable.
	Current	8mA (TYP.24VDC for each common)	40mA (24VDC) /common	△	The current value is increased.
External connection system		40-pin connector (accessory)	40-pin connector (sold separately)	○	Existing external wiring can be used.
Applicable wire size		0.3mm ²	0.3mm ² (A6CON1, A6CON4)	○	
Current consumption		0.93A (typ. all points on)	0.16A (typ. all points on)	○	
External dimensions		130(H)×34.5(W)×93.6(D)mm	98(H)×27.4(W)×90(D)mm	○	
Weight		0.27kg	0.17kg	○	

3.2.3 Comparison of I/O combined module specifications

(1) Specifications comparison between A1SH42 and QH42P

O: Compatible, Δ: Partially changed, x: Incompatible

Specifications		A1SH42	QH42P	Compat- ibility	Precautions for replacement	
Input specifications	Number of input points	32 points	32 points	○		
	Isolation method	Photocoupler	Photocoupler	○		
	Input format	Sink type	Sink type (positive common)	○		
	Rated input voltage	12/24VDC	24VDC	Δ	12VDC is not applicable.	
	Operating voltage range	10.2 to 26.4VDC (ripple ratio within 5%)	20.4 to 28.8VDC (ripple ratio within 5%)	Δ	12VDC is not applicable.	
	Rated input current	Approx. 2mA (12VDC) Approx. 5mA (24VDC)	Approx. 4mA	Δ	The rated input current is reduced.*1	
	Maximum number of simultaneous input points	60% (20 points/common) Simultaneously on (24VDC)	Refer to the derating chart.*2	○		
	On voltage/on current	8VDC or more/2mA or more	19VDC or more/3mA or more	Δ	12VDC is not applicable.*1	
	Off voltage/off current	4VDC or less/0.6mA or less	11VDC or less/1.7mA or less	Δ	12VDC is not applicable.*1	
	Input resistance	Approx. 5kΩ	Approx. 5.6kΩ	Δ	The input resistance is increased.*1	
	Response time	Off → on	10ms or less (24VDC)	1ms/5ms/10ms/20ms/70ms or less (Configure the setting in the PLC parameter dialog box.) 10ms is set by default.	○	Set the input response time of parameter to the default value (10ms).
		On → off	10ms or less (24VDC)	1ms/5ms/10ms/20ms/70ms or less (Configure the setting in the PLC parameter dialog box.) 10ms is set by default.	○	
	Common terminal arrangement	32 points/common (common terminal: 1B1, 1B2)	32 points/common (common terminal: 1B01, 1B02)	○		
Output specifications	Number of output points	32 points	32 points	○		
	Isolation method	Photocoupler	Photocoupler	○		
	Output format	Sink type	Sink type	○		
	Rated load voltage	12/24VDC	12-24VDC	○		
	Operating load voltage range	10.2 to 30VDC (peak voltage 30VDC)	10.2 to 28.8VDC (ripple ratio within 5%)	Δ	Voltage exceeding 28.8VDC is not applicable.	
	Maximum load current	0.1A/point, 1.6A/common	0.1A/point, 2A/common	○		
	Maximum inrush current	0.4A 10ms or less	0.7A 10ms or less	○		
	Leakage current at off	0.1mA or less	0.1mA or less	○		
	Maximum voltage drop at on	1.0VDC (typ.) 0.1A 2.5VDC (MAX.) 0.1A	0.1VDC (typ.) 0.1A 0.2VDC (MAX.) 0.1A	○		
	Response time	Off → on	2ms or less	1ms or less	○	
		On → off (resistance load)	2ms or less (resistance load)	1ms or less (rated load, resistance load)	○	
	Surge suppressor	Zener diode	Zener diode	○		
	Fuse rating (breaking capacity)	3.2A (1 fuse/common) Cannot be changed. (breaking capacity: 50A)	-	-		These specifications are changed to the protection function.
Fuse blown indication	Available (LED turns on when a fuse is blown and a signal is output to the CPU module.)	-	-			

Specifications		A1SH42	QH42P	Compat- ibility	Precautions for replacement
Output specifications	Protection function	-	Available (overheat protection function, overload protection function) • The overheat protection function is activated in increments of 1 point. • The overload protection function is activated in increments of 1 point.	○	
	Common terminal arrangement	32 points/common (common terminal: 2A1, 2A2)	32 points/common (common terminal: 2A01, 2A02)	○	
	External power supply	Voltage	12/24VDC (10.2 to 30VDC)	12-24VDC (10.2 to 28.8VDC ripple ratio within 5%)	△
Current		8mA (typ.24VDC for each common)	MAX. 15mA/common (24VDC, all points on)	△	The current value is increased.
Operation indication		On indication (LED) 32-point switching indication with the switch	On indication (LED) 32-point switching indication with the switch	○	
External connection system		40-pin connector 2 pieces (accessory)	40-pin connector 2 pieces (sold separately)	○	Existing external wiring can be used.
Applicable wire size		0.3mm ²	0.3mm ² (A6CON1, A6CON4)	○	
Number of occupied I/O points		32 points (I/O assignment: Output)	32 points (I/O assignment: I/O mix)	○	
Current consumption		0.50A (typ. all points on)	0.13A (typ. all points on)	○	
External dimensions		130(H)×34.5(W)×93.6(D)mm	98(H)×27.4(W)×90(D)mm	○	
Weight		0.27kg	0.20kg	○	

*1 Check the specifications of the sensor or switches to be connected to the QH42P.

*2 The following shows the derating chart.

(QH42P)

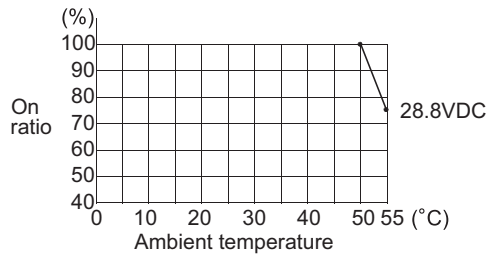

(2) Specifications comparison between A1SH42P and QH42P

○: Compatible, △: Partially changed, ×: Incompatible

Specifications		A1SH42P	QH42P	Compat- ibility	Precautions for replacement	
Input specifications	Number of input points	32 points	32 points	○		
	Isolation method	Photocoupler	Photocoupler	○		
	Input format	Sink type	Sink type (positive common)	○		
	Rated input voltage	12V/24VDC	24VDC	△	12VDC is not applicable.	
	Operating voltage range	10.2 to 26.4VDC (ripple ratio within 5%)	20.4 to 28.8VDC (ripple ratio within 5%)	△	12VDC is not applicable.	
	Rated input current	Approx. 2mA (12VDC) Approx. 5mA (24VDC)	Approx. 4mA	△	The rated input current is reduced.*1	
	Maximum number of simultaneous input points	60% (20 points/common) Simultaneously on (24VDC)	Refer to the derating chart.*2	○		
	On voltage/on current	8VDC or more/2mA or more	19VDC or more/3mA or more	△	12VDC is not applicable.*1	
	Off voltage/off current	4VDC or less/0.6mA or less	11VDC or less/1.7mA or less	△	12VDC is not applicable.*1	
	Input resistance	Approx. 5kΩ	Approx. 5.6kΩ	△	The input resistance is increased.*1	
	Response time	Off → on	10ms or less (24VDC)	1ms/5ms/10ms/20ms/70ms or less (Configure the setting in the PLC parameter dialog box.) 10ms is set by default.	○	Set the input response time of parameter to the default value (10ms).
		On → off	10ms or less (24VDC)	1ms/5ms/10ms/20ms/70ms or less (Configure the setting in the PLC parameter dialog box.) 10ms is set by default.	○	
	Common terminal arrangement		32 points/common (common terminal: 1B1, 1B2)	32 points/common (common terminal: 1B01, 1B02)	○	
Output specifications	Number of output points	32 points	32 points	○		
	Isolation method	Photocoupler	Photocoupler	○		
	Output format	Sink type	Sink type	○		
	Rated load voltage	12/24VDC	12-24VDC	○		
	Operating load voltage range	10.2 to 30VDC (peak voltage 30VDC)	10.2 to 28.8VDC (ripple ratio within 5%)	△	Voltage exceeding 28.8VDC is not applicable.	
	Maximum load current	0.1A/point, 2A/common	0.1A/point, 2A/common	○		
	Maximum inrush current	0.7A 10ms or less	0.7A 10ms or less	○		
	Leakage current at off	0.1mA or less	0.1mA or less	○		
	Maximum voltage drop at on	0.1VDC (typ.) 0.1A 0.2VDC (MAX.) 0.1A	0.1VDC (typ.) 0.1A 0.2VDC (MAX.) 0.1A	○		
	Response time	Off → on	1ms or less	1ms or less	○	
		On → off	1ms or less (resistance load)	1ms or less (rated load, resistance load)	○	
	Surge suppressor		Zener diode	Zener diode	○	
	Protection function		Available (overheat protection function, overload protection function) • The overheat protection function is activated in increments of 1 point. • The overload protection function is activated in increments of 1 point.	Available (overheat protection function, overload protection function) • The overheat protection function is activated in increments of 1 point. • The overload protection function is activated in increments of 1 point.	○	
Common terminal arrangement		32 points/common (common terminal: 2A1, 2A2)	32 points/common (common terminal: 2A01, 2A02)	○		
External power supply	Voltage	12/24VDC (10.2 to 30VDC)	12-24VDC (10.2 to 28.8VDC ripple ratio within 5%)	△	Voltage exceeding 28.8VDC is not applicable.	
	Current	12mA (typ. 24VDC for each common)	MAX. 15mA/common (24VDC, all points on)	△	The current value is increased.	
Operation indication		On indication (LED) 32-point switching indication with the switch	On indication (LED) 32-point switching indication with the switch	○		

Specifications	A1SH42P	QH42P	Compat- ibility	Precautions for replacement
External connection system	40-pin connector 2 pieces (accessory)	40-pin connector 2 pieces (sold separately)	○	Existing external wiring can be used.
Applicable wire size	0.3mm ²	0.3mm ² (A6CON1, A6CON4)	○	
Number of occupied I/O points	32 points (I/O assignment: Output)	32 points (I/O assignment: I/O mix)	○	
Current consumption	0.13A (typ. all points on)	0.13A (typ. all points on)	○	
External dimensions	130(H)×34.5(W)×93.6(D)mm	98(H)×27.4(W)×90(D)mm	○	
Weight	0.17kg	0.20kg	△	The weight is increased.

*1 Check the specifications of the sensor or switches to be connected to the QH42P.

*2 The following shows the derating chart.

(QH42P)

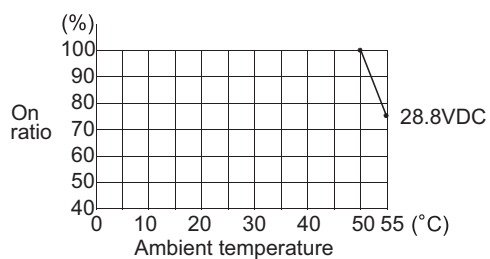

(3) Specifications comparison between A1SH42-S1 and QH42P

○: Compatible, △: Partially changed, ×: Incompatible

Specifications		A1SH42-S1	QH42P	Compat- ibility	Precautions for replacement	
Input specifications	Number of input points	32 points	32 points	○		
	Isolation method	Photocoupler	Photocoupler	○		
	Input format	Sink type	Sink type (positive common)	○		
	Rated input voltage	24VDC	24VDC	○		
	Operating voltage range	19.2 to 26.4VDC (ripple ratio within 5%)	20.4 to 28.8VDC (ripple ratio within 5%)	△	The operating voltage range differs.	
	Rated input current	Approx. 5mA	Approx. 4mA	△	The rated input current is reduced.*1	
	Maximum number of simultaneous input points	60% (20 points/common) Simultaneously on (24VDC)	Refer to the derating chart.*2	○		
	On voltage/on current	15VDC or more/3mA or more	19VDC or more/3mA or more	△	The on voltage/on current differ.*1	
	Off voltage/off current	3VDC or less/0.5mA or less	11VDC or less/1.7mA or less	△	The off voltage/off current differ.*1	
	Input resistance	Approx. 5kΩ	Approx. 5.6kΩ	△	The input resistance is increased.*1	
	Response time	Off → on	0.3ms or less	1ms/5ms/10ms/20ms/70ms or less (Configure the setting in the PLC parameter dialog box.) 10ms is set by default.	△	The response time differs. Set the time according to the control.
		On → off	0.3ms or less	1ms/5ms/10ms/20ms/70ms or less (Configure the setting in the PLC parameter dialog box.) 10ms is set by default.	△	
	Common terminal arrangement	32 points/common (common terminal: 1B1, 1B2)	32 points/common (common terminal: 1B01, 1B02)	○		
Output specifications	Number of output points	32 points	32 points	○		
	Isolation method	Photocoupler	Photocoupler	○		
	Output format	Sink type	Sink type	○		
	Rated load voltage	12/24VDC	12-24VDC	○		
	Operating load voltage range	10.2 to 30VDC (peak voltage 30VDC)	10.2 to 28.8VDC (ripple ratio within 5%)	△	Voltage exceeding 28.8VDC is not applicable.	
	Maximum load current	0.1A/point, 1.6A/common	0.1A/point, 2A/common	○		
	Maximum inrush current	0.4A 10ms or less	0.7A 10ms or less	○		
	Leakage current at of	0.1mA or less	0.1mA or less	○		
	Maximum voltage drop at on	1.0VDC (typ.) 0.1A 2.5VDC (MAX.) 0.1A	0.1VDC (typ.) 0.1A 0.2VDC (MAX.) 0.1A	○		
	Response time	Off → on	2ms or less	1ms or less	○	
		On → off (resistance load)	2ms or less (resistance load)	1ms or less (rated load, resistance load)	○	
	Surge suppressor	Zener diode	Zener diode	○		
	Fuse rating (breaking capacity)	3.2A (1 fuse/common) Cannot be changed. (breaking capacity: 50A)	-	-		These specifications are changed to the protection function.
Fuse blown indication	Available (LED turns on when a fuse is blown and a signal is output to the CPU module.)					

Specifications		A1SH42-S1	QH42P	Compat- ibility	Precautions for replacement
Output specifications	Protection function	-	Available (overheat protection function, overload protection function) • The overheat protection function is activated in increments of 1 point. • The overload protection function is activated in increments of 1 point.	○	
	Common terminal arrangement	32 points/common (common terminal: 2A1, 2A2)	32 points/common (common terminal: 2A01, 2A02)	○	
	External power supply	Voltage	12/24VDC (10.2 to 30VDC)	12-24VDC (10.2 to 28.8VDC ripple ratio within 5%)	△
Current		8mA (typ. 24VDC for each common)	MAX. 15mA/common (24VDC, all points on)	△	The current value is increased.
Operation indication		On indication (LED) 32-point switching indication with the switch	On indication (LED) 32-point switching indication with the switch	○	
External connection system		40-pin connector 2 pieces (accessory)	40-pin connector 2 pieces (sold separately)	○	Existing external wiring can be used.
Applicable wire size		0.3mm ²	0.3mm ² (A6CON1, A6CON4)	○	
Number of occupied I/O points		32 points (I/O assignment: Output)	32 points (I/O assignment: I/O mix)	○	
Current consumption		0.50A (typ. all points on)	0.13A (typ. all points on)	○	
External dimensions		130(H)×34.5(W)×93.6(D)mm	98(H)×27.4(W)×90(D)mm	○	
Weight		0.27kg	0.20kg	○	

*1 Check the specifications of the sensor or switches to be connected to the QH42P.

*2 The following shows the derating chart.

(QH42P)

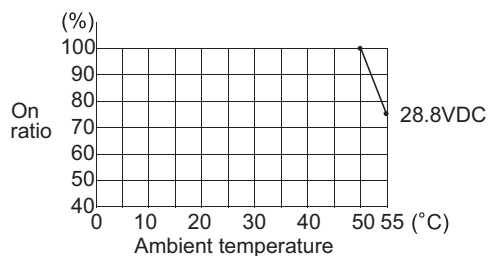

(4) Specifications comparison between A1SH42P-S1 and QH42P

○: Compatible, △: Partially changed, ×: Incompatible

Specifications		A1SH42P-S1	QH42P	Compat- ibility	Precautions for replacement	
Input specifications	Number of input points	32 points	32 points	○		
	Isolation method	Photocoupler	Photocoupler	○		
	Input format	Sink type	Sink type (positive common)	○		
	Rated input voltage	24VDC	24VDC	○		
	Operating voltage range	19.2 to 26.4VDC (ripple ratio within 5%)	20.4 to 28.8VDC (ripple ratio within 5%)	△	The operating voltage range differs.	
	Rated input current	Approx. 5mA	Approx. 4mA	△	The rated input current is reduced.*1	
	Maximum number of simultaneous input points	60% (20 points/common) Simultaneously on (24VDC)	Refer to the derating chart.*2	○		
	On voltage/on current	15VDC or more/3mA or more	19VDC or more/3mA or more	△	The on voltage/on current differ.*1	
	Off voltage/off current	3VDC or less/0.5mA or less	11VDC or less/1.7mA or less	△	The off voltage/off current differ.*1	
	Input resistance	Approx. 5kΩ	Approx. 5.6kΩ	△	The input resistance is increased.*1	
	Response time	Off → on	0.3ms or less	1ms/5ms/10ms/20ms/70ms or less (Configure the setting in the PLC parameter dialog box.) 10ms is set by default.	△	The response time differs. Set the time according to the control.
		On → off	0.3ms or less	1ms/5ms/10ms/20ms/70ms or less (Configure the setting in the PLC parameter dialog box.) 10ms is set by default.	△	
	Common terminal arrangement	32 points/common (common terminal: 1B1, 1B2)	32 points/common (common terminal: 1B01, 1B02)	○		
Output specifications	Number of output points	32 points	32 points	○		
	Isolation method	Photocoupler	Photocoupler	○		
	Output format	Sink type	Sink type	○		
	Rated load voltage	12/24VDC	12-24VDC	○		
	Operating load voltage range	10.2 to 30VDC (peak voltage 30VDC)	10.2 to 28.8VDC (ripple ratio within 5%)	△	Voltage exceeding 28.8VDC is not applicable.	
	Maximum load current	0.1A/point, 2A/common	0.1A/point, 2A/common	○		
	Maximum inrush current	0.7A 10ms or less	0.7A 10ms or less	○		
	Leakage current at off	0.1mA or less	0.1mA or less	○		
	Maximum voltage drop at on	0.1VDC (typ.) 0.1A 0.2VDC (MAX.) 0.1A	0.1VDC (typ.) 0.1A 0.2VDC (MAX.) 0.1A	○		
	Response time	Off → on	1ms or less	1ms or less	○	
		On → off (resistance load)	1ms or less (resistance load)	1ms or less (rated load, resistance load)	○	
	Surge suppressor	Zener diode	Zener diode	○		
	Protection function	Available (overheat protection function, overload protection function) • The overheat protection function is activated in increments of 1 point. • The overload protection function is activated in increments of 1 point.	Available (overheat protection function, overload protection function) • The overheat protection function is activated in increments of 1 point. • The overload protection function is activated in increments of 1 point.	○		
	Common terminal arrangement	32 points/common (common terminal: 2A1, 2A2)	32 points/common (common terminal: 2A01, 2A02)	○		
	External power supply	Voltage	12/24VDC (10.2 to 30VDC)	12-24VDC (10.2 to 28.8VDC ripple ratio within 5%)	△	Voltage exceeding 28.8VDC is not applicable.
Current		12mA (typ. 24VDC for each common)	MAX. 15mA/common (24VDC, all points on)	△	The current value is increased.	
Operation indication	On indication (LED) 32-point switching indication with the switch	On indication (LED) 32-point switching indication with the switch	○			

Specifications	A1SH42P-S1	QH42P	Compat- ibility	Precautions for replacement
External connection system	40-pin connector 2 pieces (accessory)	40-pin connector 2 pieces (sold separately)	○	Existing external wiring can be used.
Applicable wire size	0.3mm ²	0.3mm ² (A6CON1, A6CON4)	○	
Number of occupied I/O points	32 points (I/O assignment: Output)	32 points (I/O assignment: I/O mix)	○	
Current consumption	0.13A (typ. all points on)	0.13A (typ. all points on)	○	
External dimensions	130(H)×34.5(W)×93.6(D)mm	98(H)×27.4(W)×90(D)mm	○	
Weight	0.17kg	0.20kg	△	The weight is increased.

*1 Check the specifications of the sensor or switches to be connected to the QH42P.

*2 The following shows the derating chart.

(QH42P)

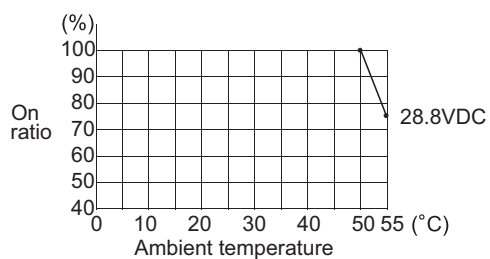

(5) Specifications comparison between A1SX48Y18 and QX40/QY10

(a) Specifications comparison between A1SX48Y18 (input part) and QX40

○: Compatible, △: Partially changed, ×: Incompatible

Specifications		A1SX48Y18 (input specifications)	QX40	Compat- ibility	Precautions for replacement
Number of input points		8 points	16 points	○	
Isolation method		Photocoupler	Photocoupler	○	
Input format		Sink type	Sink type (positive common)	○	
Rated input voltage		24VDC	24VDC	○	
Rated input current		Approx. 7mA	Approx. 4mA	△	The rated input current is reduced.*1
Operating voltage range		19.2 to 26.4VDC (ripple ratio within 5%)	20.4 to 28.8VDC (ripple ratio within 5%)	△	The operating voltage range differs.
Maximum number of simultaneous input points		Simultaneously on (100%) (26.4VDC)	Simultaneously on (100%)	○	
On voltage/on current		14VDC or more/3.5mA or more	19VDC or more/3mA or more	△	The on voltage/on current differ.*1
Off voltage/off current		6.5VDC or less/1.7mA or less	11VDC or less/1.7mA or less	△	The off voltage differs.*1
Input resistance		Approx. 3.3kΩ	Approx. 5.6kΩ	△	The input resistance is increased.*1
Response time	Off → on	10ms or less (24VDC)	1ms/5ms/10ms/20ms/70ms or less (Configure the setting in the PLC parameter dialog box.) 10ms is set by default.	○	Set the input response time of parameter to the default value (10ms).
	On → off	10ms or less (24VDC)	1ms/5ms/10ms/20ms/70ms or less (Configure the setting in the PLC parameter dialog box.) 10ms is set by default.	○	
Common terminal arrangement		8 points/common (common terminal: TB9)	16 points/common (common terminal: TB17)	○	
Operation indication		On indication (LED)	On indication (LED)	○	
External connection system		20-point terminal block connector (M3.5×7 screws)	18-point terminal block (M3×6 screws)	×	Wiring change is required.
Applicable wire size		0.75 to 1.25mm ²	Core: 0.3 to 0.75mm ² (outside diameter: 2.8mm (0.11 inches) or less)	×	
Applicable solderless terminal		R1.25-3.5, R2-3.5, RAV1.25-3.5, RAV2-3.5	R1.25-3 (Sleeved solderless terminal cannot be used.)	×	
Number of occupied I/O points		16 points (I/O assignment: Output 16 points)	16 points (I/O assignment: Input 16 points)	△	When both the QX40 and QY10 are used, the number of occupied points is 32 (16 points × 2 modules).
Current consumption		0.085A (typ. all points on)	0.05A (typ. all points on)	-	The module configuration differs. Recalculate the current consumption.
External dimensions		130(H)×34.5(W)×93.6(D)mm	98(H)×27.4(W)×90(D)mm	△	Wiring space is narrower.
Weight		0.23kg	0.16kg	○	

*1 Check the specifications of the sensor or switches to be connected to the QX40.

(b) Specifications comparison between A1SX48Y18 (output part) and QY10

○: Compatible, △: Partially changed, ×: Incompatible

Specifications		A1SX48Y18 (output specifications)	QY10	Compat- ibility	Precautions for replacement
Number of output points		8 points	16 points	○	
Isolation method		Photocoupler	Relay	△	The isolation method differs, but the performance is the equivalent.
Output format		Contact output	Contact output	○	
Rated switching voltage/ current		24VDC 2A (resistance load) 240VAC 2A (COSφ=1)/point, 8A/common	24VDC 2A (resistance load)/point 240VAC 2A (COSφ=1)/point, 8A/common	○	
Minimum switching load		5VDC 1mA	5VDC 1mA	○	
Maximum switching voltage		264VAC 125VDC	264VAC 125VDC	○	
Response time	Off → on	10ms or less	10ms or less	○	
	On → off	12ms or less	12ms or less	○	
Life	Mechanical	20 million times or more	20 million times or more	○	
	Electrical	Rated switching voltage/current load 100,000 times or more	Rated switching voltage/current load 100,000 times or more	○	
		200VAC 1.5A, 240VAC 1A (COSφ=0.7) 100,000 times or more	200VAC 1.5A, 240VAC 1A (COSφ=0.7) 100,000 times or more 200VAC 0.4A, 240VAC 0.3A (COSφ=0.7) 300,000 times or more	○	
		200VAC 1A, 240VAC 0.5A (COSφ=0.35) 100,000 times or more	200VAC 1A, 240VAC 0.5A (COSφ=0.35) 100,000 times or more 200VAC 0.3A, 240VAC 0.15A (COSφ=0.35) 300,000 times or more		
24VDC 1A, 100VDC 0.1A (L/R=7ms) 100,000 times or more	24VDC 1A, 100VDC 0.1A (L/R=7ms) 100,000 times or more 24VDC 0.3A, 100VDC 0.03A (L/R=7ms) 300,000 times or more				
Maximum switching frequency		3600 times/hr	3600 times/hr	○	
Common terminal arrangement		8 points/common (common terminal: TB18)	16 points/common (common terminal: TB17)	○	
Operation indication		On indication (LED)	On indication (LED)	○	
Fuse		None	None	-	
External power supply	Voltage	24VDC±10% Ripple voltage 4Vp-p or less	-	○	An external power supply is not required.
	Current	45mA (TYP, 24VDC, all points on)	-	○	
External connection system		20-point terminal block connector (M3.5×7 screws)	18-point terminal block (M3×6 screws)	×	Wiring change is required.
Applicable wire size		0.75 to 1.25mm ²	Core: 0.3 to 0.75mm ² (outside diameter: 2.8mm (0.11 inches) or less)	×	
Applicable solderless terminal		R1.25-3.5, R2-3.5, RAV1.25-3.5, RAV2-3.5	R1.25-3 (Sleeved solderless terminal cannot be used.)	×	
Number of occupied I/O points		16 points (I/O assignment: Output 16 points)	16 points (I/O assignment: Output 16 points)	○	When both the QX40 and QY10 are used, the number of occupied points is 32 (16 points × 2 modules).
Current consumption		0.085A (typ. all points on)	0.43A (typ. all points on)	-	The module configuration differs. Recalculate the current consumption.
External dimensions		130(H)×34.5(W)×93.6(D)mm	98(H)×27.4(W)×90(D)mm	△	Wiring space is narrower.
Weight		0.23kg	0.22kg	○	

(6) Specifications comparison between A1SX48Y58 and QX48Y57

(a) Specifications comparison between A1SX48Y58 (input part) and QX48Y57(input part)

○: Compatible, △: Partially changed, ×: Incompatible

Specifications		A1SX48Y58 (input specifications)	QX48Y57 (input specifications)	Compat- ibility	Precautions for replacement
Number of input points		8 points	8 points	○	
Isolation method		Photocoupler	Photocoupler	○	
Input format		Sink type	Sink type (positive common)	○	
Rated input voltage		24VDC	24VDC	○	
Rated input current		Approx. 7mA	Approx. 4mA	△	The rated input current is reduced.*1
Operating voltage range		19.2 to 26.4VDC (ripple ratio within 5%)	20.4 to 28.8VDC (ripple ratio within 5%)	△	The operating voltage range differs.
Maximum number of simultaneous input points		Simultaneously on (100%) (26.4VDC)	Simultaneously on (100%)	○	
On voltage/on current		14VDC or more/3.5mA or more	19VDC or more/3mA or more	△	The on voltage/on current differ.*1
Off voltage/off current		6.5VDC or less/1.7mA or less	11VDC or less/1.7mA or less	△	The off voltage differs.*1
Input resistance		Approx. 3.3kΩ	Approx. 5.6kΩ	△	The input resistance is increased.*1
Response time	Off → on	10ms or less (24VDC)	1ms/5ms/10ms/20ms/70ms or less (Configure the setting in the PLC parameter dialog box.) 10ms is set by default.	○	Set the input response time of parameter to the default value (10ms).
	On → off	10ms or less (24VDC)	1ms/5ms/10ms/20ms/70ms or less (Configure the setting in the PLC parameter dialog box.) 10ms is set by default.	○	
Common terminal arrangement		8 points/common (common terminal: TB9)	8 points/common (common terminal: TB9)	○	
Operation indication		On indication (LED)	On indication (LED)	○	
External connection system		20-point terminal block (M3.5×7 screws)	18-point terminal block (M3×6 screws)	×	Wiring change is required.
Applicable wire size		0.75 to 1.25mm ²	Core: 0.3 to 0.75mm ² (outside diameter: 2.8mm (0.11 inches) or less)	×	
Applicable solderless terminal		R1.25-3.5, R2-3.5 RAV1.25-3.5, RAV2-3.5	R1.25-3 (Sleeved solderless terminal cannot be used.)	×	
Number of occupied I/O points		16 points (I/O assignment: Output 16 points)	16 points (I/O assignment: I/O mix 16 points)	○	
Current consumption		0.06A (typ. all points on)	0.08A (typ. all points on)	△	Review the current capacity since the current consumption is increased.
External dimensions		130(H)×34.5(W)×93.6(D)mm	98(H)×27.4(W)×90(D)mm	△	Wiring space is narrower.
Weight		0.20kg	0.20kg	○	

*1 Check the specifications of the sensor or switch to be connected to the QX48Y57.

(b) Specifications comparison between A1SX48Y58 (output part) and QX48Y57(output part)

○: Compatible, △: Partially changed, ×: Incompatible

Specifications		A1SX48Y58 (output specifications)	QX48Y57 (output specifications)	Compat- ibility	Precautions for replacement
Number of output points		8 points	7 points	△	When 8 or more points are used, use two QX48Y57 modules.
Isolation method		Photocoupler	Photocoupler	○	
Output format		Sink type	Sink type	○	
Rated load voltage		12/24VDC	12-24VDC	○	
Operating load voltage range		10.2 to 30VDC (peak voltage 30VDC)	10.2 to 28.8VDC	△	Voltage exceeding 28.8VDC is not applicable.
Maximum load current		0.5A/point, 2A/common	0.5A/point, 2A/common	○	
Maximum inrush current		4A 10ms or less	4A 10ms or less	○	
Leakage current at off		0.1mA or less	0.1mA or less	○	
Maximum voltage drop at on		0.9VDC (typ.) 0.5A, 1.5VDC (MAX.) 0.5A	0.2VDC (typ.) 0.5A, 0.3VDC (MAX.) 0.5A	○	
Response time	Off → on	2ms or less	1ms or less	○	
	On → off	2ms or less (resistance load)	1ms or less (rated load, resistance load)	○	
Surge suppressor		Zener diode	Zener diode	○	
Fuse rating (breaking capacity)		3.2A (1 fuse/common) Cannot be changed. (breaking capacity: 50A)	4A (1 fuse/common) Cannot be changed. (breaking capacity: 50A)	○	
Fuse blown indication		Available (LED turns on when a fuse is blown and a signal is output to the CPU module.)	Available (LED turns on when a fuse is blown and a signal is output to the CPU module.)		
Common terminal arrangement		8 points/common (common terminal: TB19)	7 points/common (common terminal: TB18)	△	8 points/common is changed to 7 points/common.
External power supply	Voltage	12/24VDC (10.2 to 30VDC)	12-24VDC (+20/-15%) (ripple ratio within 5%)	△	Voltage exceeding 28.8VDC is not applicable.
	Current	60mA (typ. 24VDC for each common)	10mA (24VDC)	○	

(7) Specifications comparison between A1SJ-56DT and QX40/QY50

(a) Specifications comparison between A1SJ-56DT (input part) and QX40

O: Compatible, Δ: Partially changed, ×: Incompatible

Specifications		A1SJ-56DT (input specifications)	QX40	Compat- ibility	Precautions for replacement
Number of input points		32 points	16 points	Δ	When 17 or more points are used, use two QX40 modules.
Isolation method		Photocoupler	Photocoupler	O	
Input format		Sink type	Sink type (positive common)	O	
Rated input voltage		24VDC	24VDC	O	
Rated input current		Approx. 7mA	Approx. 4mA	Δ	The rated input current is reduced.*1
Operating voltage range		19.2 to 26.4VDC (ripple ratio within 5%)	20.4 to 28.8VDC (ripple ratio within 5%)	Δ	The operating voltage range differs.
Maximum number of simultaneous input points		60% (10 points/common)	Simultaneously on (100%)	O	
On voltage/on current		14VDC or more/3.5mA or more	19VDC or more/3mA or more	Δ	The on voltage/on current differ.*1
Off voltage/off current		6.5VDC or less/1.7mA or less	11VDC or less/1.7mA or less	Δ	The off voltage differs.*1
Input resistance		Approx. 3.3kΩ	Approx. 5.6kΩ	Δ	The input resistance is increased.*1
Response time	Off → on	10ms or less (24VDC)	1ms/5ms/10ms/20ms/70ms or less (Configure the setting in the PLC parameter dialog box.) 10ms is set by default.	O	Set the input response time of parameter to the default value (10ms).
	On → off	10ms or less (24VDC)	1ms/5ms/10ms/20ms/70ms or less (Configure the setting in the PLC parameter dialog box.) 10ms is set by default.	O	
Common terminal arrangement		16 points/common (common terminal: TB17, TB34)	16 points/common (common terminal: TB17)	O	
Operation indication		On indication (LED)	On indication (LED)	O	
External connection system		34-point terminal block connector 2 pieces (M3.5×6 screws)	18-point terminal block (M3×6 screws)	×	Wiring change is required.
Applicable wire size		0.75 to 2mm ²	Core: 0.3 to 0.75mm ² (outside diameter: 2.8mm (0.11 inches) or less)	×	
Applicable solderless terminal		R1.25-3.5, R2-3.5 RAV1.25-3.5, RAV2-3.5	R1.25-3 (Sleeved solderless terminal cannot be used.)	×	
Number of occupied I/O points		128 points (slot 0: Output 64 points, slots 1 to 4: Empty 16 points)	16 points (I/O assignment: Input 16 points)	-	
Current consumption		0.22A (typ. all points on)	0.05A (typ. all points on)	-	The module configuration differs. Recalculate the current consumption.
External dimensions		130(H)×174.5(W)×65.6(D)mm	98(H)×27.4(W)×90(D)mm	Δ	Wiring space is narrower.
Weight		0.70kg	0.16kg	O	

*1 Check the specifications of the sensor or switches to be connected to the QX40.

(b) Specifications comparison between A1SJ-56DT (output part) and QY50

○: Compatible, △: Partially changed, ×: Incompatible

Specifications		A1SJ-56DT (output specifications)	QY50	Compat- ibility	Precautions for replacement
Number of output points		24 points	16 points	△	When 17 or more points are used, use two QY50 modules.
Isolation method		Photocoupler	Photocoupler	○	
Output format		Sink type	Sink type	○	
Rated load voltage		24VDC	12-24VDC	○	
Operating load voltage range		19.2 to 30VDC (peak voltage 30VDC)	10.2 to 28.8VDC	△	Voltage exceeding 28.8VDC is not applicable.
Maximum load current		0.5A/point, 4A/common	0.5A/point, 4A/common	○	
Maximum inrush current		4A 10ms or less	4A 10ms or less	○	
Leakage current at off		0.1mA or less	0.1mA or less	○	
Maximum voltage drop at off		0.9V (typ.) 0.5A 1.5V (MAX.) 0.5A	0.2VDC (typ.) 0.5A, 0.3VDC (MAX.) 0.5A	○	
Response time	Off → on	2ms or less	1ms or less	○	
	On → off	2ms or less (resistance load)	1ms or less (rated load, resistance load)	○	
Surge suppressor		Zener diode	Zener diode	○	
Common terminal arrangement		8 points/common (common terminal: TB10, TB20, TB30)	16 points/common (common terminal: TB18)	△	As the number of points per common is changed to 16, wiring with a different voltage for each common is not possible.
Operation indication		On indication (LED)	On indication (LED)	○	
Fuse rating (breaking capacity)		None	6.7A (1 fuse/common) Cannot be changed. (breaking capacity: 50A)	○	The QY50 does not detect fuse blown unless the external power is supplied.
Fuse blown indication			Available (LED turns on when a fuse is blown and a signal is output to the CPU module.)		
External power supply	Voltage	24VDC (19.2 to 30VDC)	12-24VDC (+20/-15%) (ripple ratio within 5%)	△	Voltage exceeding 28.8VDC is not applicable.
	Current	60mA (typ. 24VDC for each common)	20mA (24VDC)	○	
External connection system		34-point terminal block connector 2 pieces (M3.5×6 screws)	18-point terminal block (M3×6 screws)	×	Wiring change is required.
Applicable wire size		0.75 to 2mm ²	Core: 0.3 to 0.75mm ² (outside diameter: 2.8mm (0.11 inches) or less)	×	
Applicable solderless terminal		R1.25-3.5, R2-3.5 RAV1.25-3.5, RAV2-3.5	R1.25-3 (Sleeved solderless terminal cannot be used.)	×	
Number of occupied I/O points		128 points (slot 0: Output 64 points, slots 1 to 4: Empty 16 points)	16 points (I/O assignment: Output 16 points)	-	
Current consumption		0.22A (typ. all points on)	0.08A (typ. all points on)	-	The module configuration differs. Recalculate the current consumption.
External dimensions		130(H)×174.5(W)×65.6(D)mm	98(H)×27.4(W)×90(D)mm	△	Wiring space is narrower.
Weight		0.70kg	0.17kg	○	

(8) Specifications comparison between A1SJ-56DR and QX40/QY10

(a) Specifications comparison between A1SJ-56DR (input part) and QX40

○: Compatible, △: Partially changed, ×: Incompatible

Specifications		A1SJ-56DR (input specifications)	QX40	Compat- ibility	Precautions for replacement
Number of input points		32 points	16 points	△	When 17 or more points are used, use two QX40 modules.
Isolation method		Photocoupler	Photocoupler	○	
Input format		Sink input	Sink input (positive common)	○	
Rated input voltage		24VDC	24VDC	○	
Rated input current		Approx. 7mA	Approx. 4mA	△	The rated input current is reduced.*1
Operating voltage range		19.2 to 26.4VDC (ripple ratio within 5%)	20.4 to 28.8VDC (ripple ratio within 5%)	△	The operating voltage range differs.
Maximum number of simultaneous input points		60% (10 points/common) Simultaneously on	Simultaneously on (100%)	○	
On voltage/on current		14VDC or more/3.5mA or more	19VDC or more/3mA or more	△	The on voltage and on current differ.*1
Off voltage/off current		6.5VDC or less/1.7mA or less	11VDC or less/1.7mA or less	△	The off voltage differs.*1
Input resistance		Approx. 3.3kΩ	Approx. 5.6kΩ	△	The input resistance is increased.*1
Response time	Off → on	10ms or less (24VDC)	1ms/5ms/10ms/20ms/70ms or less (Configure the setting in the PLC parameter dialog box.) 10ms is set by default.	○	Set the input response time of parameter to the default value (10ms).
	On → off	10ms or less (24VDC)	1ms/5ms/10ms/20ms/70ms or less (Configure the setting in the PLC parameter dialog box.) 10ms is set by default.	○	
Common terminal arrangement		16 points/common (common terminal: TB17, TB34)	16 points/common (common terminal: TB17)	○	
Operation indication		On indication (LED)	On indication (LED)	○	
External connection system		34-point terminal block connector 2 pieces (M3.5×6 screws)	18-point terminal block (M3×6 screws)	×	Wiring change is required.
Applicable wire size		0.75 to 2mm ²	Core: 0.3 to 0.75mm ² (outside diameter: 2.8mm (0.11 inches) or less)	×	
Applicable solderless terminal		R1.25-3.5, R2-3.5 RAV1.25-3.5, RAV2-3.5	R1.25-3 (Sleeved solderless terminal cannot be used.)	×	
Number of occupied I/O points		128 points (slot 0: Output 64 points, slots 1 to 4: Empty 16 points)	16 points (I/O assignment: Input 16 points)	-	
Current consumption		0.22A (typ. all points on)	0.05A (typ. all points on)	-	The module configuration differs. Recalculate the current consumption.
External dimensions		130(H)×174.5(W)×65.6(D)mm	98(H)×27.4(W)×90(D)mm	△	Wiring space is narrower.
Weight		0.80kg	0.16kg	○	

*1 Check the specifications of the sensor or switches to be connected to the QX40.

(b) Specifications comparison between A1SJ-56DR (output part) and QY10

○: Compatible, △: Partially changed, ×: Incompatible

Specifications		A1SJ-56DR (output specifications)	QY10	Compat- ibility	Precautions for replacement
Number of output points		24 points	16 points	△	When 17 or more points are used, use two QY10 modules.
Isolation method		Photocoupler	Relay	△	The isolation method differs, but the performance is the equivalent.
Output format		Contact output	Contact output	○	
Rated switching voltage/ current		24VDC 2A (resistance load) 240VAC 2A (COSφ=1)/point, 5A/common	24VDC 2A (resistance load) 240VAC 2A (COSφ=1)/point, 8A/common	○	
Minimum switching load		5VDC 1mA	5VDC 1mA	○	
Maximum switching load		264VAC 125VDC	264VAC 125VDC	○	
Maximum switching frequency		3600 times/hr	3600 times/hr	○	
Surge suppressor		None	None	-	
Response time	Off → on	10ms or less	10ms or less	○	
	On → off	12ms or less	12ms or less	○	
Life	Mechanical	20 million times or more	20 million times or more	○	
	Electrical	Rated switching voltage/current load 100,000 times or more	Rated switching voltage/current load 100,000 times or more	○	
		200VAC 1.5A, 240VAC 1A (COSφ=0.7) 100,000 times or more	200VAC 1.5A, 240VAC 1A (COSφ=0.7) 100,000 times or more 200VAC 0.4A, 240VAC 0.3A (COSφ=0.7) 300,000 times or more	○	
		200VAC 1A, 240VAC 0.5A (COSφ=0.35) 100,000 times or more	200VAC 1A, 240VAC 0.5A (COSφ=0.35) 100,000 times or more 200VAC 0.3A, 240VAC 0.15A (COSφ=0.35) 300,000 times or more		
24VDC 1A, 100VDC 0.1A (L/R=7ms) 100,000 times or more	24VDC 1A, 100VDC 0.1A (L/R=7ms) 100,000 times or more 24VDC 0.3A, 100VDC 0.03A (L/R=7ms) 300,000 times or more				
Common terminal arrangement		8 points/common (common terminal: TB9, TB18, TB27)	16 points/common (common terminal: TB17)	△	As the number of points per common is changed to 16, wiring with a different voltage for each common is not possible.
Operation indication		On indication (LED)	On indication (LED)	○	
Fuse		None	None	-	
External power supply	Voltage	24VDC±10% Ripple voltage 4Vp-p or less	-	○	An external power supply is not required.
	Current	140mA (typ. 24VDC, all points on)	-	○	
External connection system		34-point terminal block connector 2 pieces (M3.5×6 screws)	18-point terminal block (M3×6 screws)	×	Wiring change is required.
Applicable wire size		0.75 to 2mm ²	Core: 0.3 to 0.75mm ² (outside diameter: 2.8mm (0.11 inches) or less)	×	
Applicable solderless terminal		R1.25-3.5, R2-3.5, RAV1.25-3.5, RAV2-3.5	R1.25-3 (Sleeved solderless terminal cannot be used.)	×	
Number of occupied I/O points		128 points (slot 0: Output 64 points, slots 1 to 4: Empty 16 points)	16 points (I/O assignment: Output 16 points)	-	
Current consumption		0.22A (typ. all points on)	0.43A (typ. all points on)	-	The module configuration differs. Recalculate the current consumption.
External dimensions		130(H)×174.5(W)×65.6(D)mm	98(H)×27.4(W)×90(D)mm	△	Wiring space is narrower.
Weight		0.80kg	0.22kg	○	

3.2.4 Comparison of interrupt module specifications

(1) Specifications comparison between A1SI61 and QI60

○: Compatible, △: Partially changed, ×: Incompatible

Specifications		A1SI61	QI60	Compat- ibility	Precautions for replacement
Number of interrupt input points		16 points	16 points	○	
Isolation method		Photocoupler	Photocoupler	○	
Rated input voltage		12/24VDC	24VDC	△	12VDC is not applicable.
Rated input current		Approx. 4mA (12VDC) Approx. 8mA (24VDC)	Approx. 6mA	△	The rated input current is reduced.*1
Operating voltage range		10.2 to 26.4VDC	20.4 to 28.8VDC (ripple ratio within 5%)	△	12VDC is not applicable.
Maximum number of simultaneous input points		Simultaneously on (100%)	Simultaneously on (100%)	○	
On voltage		9VDC or more/3mA or more	19VDC or more/4.0mA or more	△	12VDC is not applicable.*1
Off voltage		4VDC or less/1mA or less	11VDC or less/1.7mA or less	△	12VDC is not applicable.*1
Input resistance		Approx. 2.7kΩ	Approx. 3.9kΩ	△	The input resistance is increased.*1
Response time	Off → on	0.2ms or less	0.1ms/0.2ms/0.4ms/0.6ms/1ms or less (Configure the setting in the PLC parameter dialog box.) 0.2ms is set by default.	○	Set the input response time of parameter to the default value (0.2ms).
	On → off	0.2ms or less	0.1ms/0.2ms/0.4ms/0.6ms/1ms or less (Configure the setting in the PLC parameter dialog box.) 0.2ms is set by default.	○	
Interrupt condition setting		In increments of 4 points	In increments of 1 point	○	
Common terminal arrangement		16 points/common (common terminal: TB9, TB18)	16 points/common (common terminal: TB17)	○	
Operation indication		On indication (LED)	On indication (LED)	○	
External connection system		20-point terminal block connector (M3.5×7 screws)	18-point terminal block (M3×6 screws)	×	Wiring change is required.
Applicable wire size		0.75 to 1.5mm ²	Core: 0.3 to 0.75mm ² (outside diameter: 2.8mm (0.11 inches) or less)	×	
Applicable solderless terminal		1.25-3.5, 1.25-YS3A, 2-3.5, 2-YS3A, V1.25-3.5, V1.25-YS3A, V2-S3, V2-YS3A	R1.25-3 (Sleeved solderless terminal cannot be used.)	×	
Number of occupied I/O points		32 points (I/O assignment: special 32 points)	16 points (I/O assignment: Interrupt)	△	The number of occupied I/O points differs.
Current consumption		0.057A (TYP, all points on)	0.06A (TYP, all points on)	○	
External dimensions		130(H)×34.5(W)×93.6(D)mm	98(H)×27.4(W)×90(D)mm	△	Wiring space is narrower.
Weight		0.20kg	0.20kg	○	

*1 Check the specifications of the sensor or switch to be connected to the QI60.

3.2.5 Comparison of blank cover and dummy module specifications

(1) Specifications comparison between A1SG60 and QG60

○: Compatible, △: Partially changed, ×: Incompatible

Specifications	A1SG60	QG60	Compat- ibility	Precautions for replacement
Number of occupied I/O points	Empty slot (default: empty 16 points)	Empty slot (default: empty 16 points)	○	
I/O assignment classification	Selected from empty 0, 16, 32, 48, and 64 points. (default: 16 points)	Selected from empty 0, 16, 32, 48, 64, 128, 256, 512, and 1024 points. (default: 16 points)	○	The number of occupied points can be set or changed in the I/O assignment tab of the PLC parameter dialog box.
Application	Mounted to the slot where no I/O module is mounted (especially the empty slot between modules) for dust control.		○	
External dimensions	130(H)×34.5(W)×93.6(D)mm	98(H)×27.4(W)×90(D)mm	○	
Weight	0.08kg	0.07kg	○	

(2) Specifications comparison between A1SG62 and QG60

○: Compatible, △: Partially changed, ×: Incompatible

Specifications	A1SG62	QG60	Compat- ibility	Precautions for replacement
Number of occupied I/O points	Maximum 64 points (selected from 16, 32, 48, and 64 points by the switch on the front of the module.)	Empty slot (default: empty 16 points)	△	The setting methods differ. The number of occupied points can be set or changed in the I/O assignment tab of the PLC parameter dialog box.
I/O assignment classification	Configure the setting by the switch for the number of occupied input points. (16, 32, 48, 64 points)	Selected from empty 0, 16, 32, 48, 64, 128, 256, 512, and 1024 points. (default: 16 points)	△	
Application	Mounted to reserve points (16, 32, 48, and 64 points) in advance for future expansion.	Mounted to the slot where no I/O module is mounted (especially the empty slot between modules) for dust control.	△	
Current consumption	0.06A	-	-	
External dimensions	130(H)×34.5(W)×93.6(D)mm	98(H)×27.4(W)×90(D)mm	△	
Weight	0.13kg	0.07kg	○	

3.3 Precautions for I/O Module Replacement

(1) Size of wire and solderless terminal

Since the module and terminal block of the Q series are smaller than those of the A series, the applicable size of wire and solderless terminal for a terminal block differ between the two series. Therefore, when replacing the A series with the Q series, use the wire and solderless terminal that meet the specifications of the Q series I/O modules.

(2) Connectors for external wiring

(a) Connectors for external wiring are not came with Q series 32- and 64-point I/O modules.

Purchase the connector (A6CON□) as required.

(b) The pin layout is the same between AnS series and Q series I/O modules (connector type).

External wiring can be used even after AnS series I/O modules are replaced by Q series I/O modules.

(Without changing external wiring, existing connectors can be connected to Q series I/O modules.)

Note that, for modules having a 37-pin connector, the connecting direction of the connector is inverted between the AnS series and Q series.

(3) Precautions for input module

(a) Specifications change of rated input current

Check the specifications of connecting devices (such as sensors and switches) since rated input current is reduced for some Q series input modules compared to that for the AnS series.

(b) Specifications change of off current

Check the specifications of connecting devices (such as sensors and switches) since off current is reduced for some Q series input modules compared to that for the AnS series.

(c) Specifications change of the maximum number of simultaneous input points

The maximum number of simultaneous input points is reduced for some Q series input modules compared to that for the AnS series.

When replacing the AnS series with the Q series, refer to the derating chart and use the points within the range shown in the chart.

(d) Specifications change of rated voltage value

For the Q series QX4□ and QX8□ DC input modules, only 24VDC can be applied.

When applying 12VDC, use the QX7□.

(e) Specifications change of response time

For Q series DC input modules, the I/O response time can be set with parameters.

Set the I/O response time with parameters while adjusting it to the response time of the AnS series module.

(f) Specifications change of common terminal arrangement

The common terminal arrangement may differ between the AnS series and Q series. To apply different voltages for each common, take measures, such as using different modules according to the applied voltage.

(4) Precautions for output module

(a) Specifications change of output current value

Output current is reduced for some Q series output modules compared to that for the AnS series. When using a Q series output module of smaller output current, check the specifications of a load side.

(b) Specifications change of common terminal arrangement

The common terminal arrangement may differ between the AnS series and Q series. To apply different voltages for each common, take measures, such as using different modules according to the applied voltage.

(c) Specifications change of maximum load current per common

The maximum load current per common may differ between the AnS series and Q series. Check the specifications of the maximum load current per common for both series.

4 REPLACEMENT OF POWER SUPPLY MODULE

4.1 List of Alternative Models of Power Supply Module

AnS/QnAS series model		Q series alternative model	
Product	Model	Model	Remarks (restrictions)
Power supply module	A1S61PN	Q61P	1) Change in external wiring: required 2) Change in slots: not required 3) Change in specifications: required (current capacity: 5A → 6A)
		Q61SP*1	1) Change in external wiring: required 2) Change in slots: can be used with the slim type main base unit (Q3□SB) only. 3) Change in specifications: required (current capacity: 5A → 2A)
	A1S62PN	Q62P	1) Change in external wiring: required 2) Change in slots: not required 3) Change in specifications: not required
	A1S63P	Q63P	1) Change in external wiring: required 2) Change in slots: not required 3) Change in specifications: required (current capacity: 5A → 6A).
	A1SJHCPU (power supply part)	Q00UJCPU Q00JCPU (power supply part)	1) Change in external wiring: required 2) Change in slots: not required (Main base unit, CPU module, and power supply module are integrated.) 3) Change in specifications: required (The input power supply is switched between 100 and 120V or 200 and 240V. (In-between voltage cannot be applied.) → wide range applicable to 100 to 240V

*1 The Q61SP may be used when only a few modules are replaced, and connection of an extension base is unnecessary. The output current capacity is limited, please confirm the total current consumption of the system.

☒ Point

For details of replacing power supply modules when using A/QnS extension base unit, please refer to the following manual.

Transition from MELSEC-A/QnA (Large Type) Series to Q Series Handbook (Fundamentals)
L08043ENG

4.2 Comparison of Power Supply Module Specifications

(1) Specifications comparison between A1S61PN and Q61P

○: Compatible, △: Partially changed ×: Incompatible

Specifications	A1S61PN	Q61P	Compat- ibility	Precautions for replacement
Input power supply	100-240VAC+10%-15% (85 to 264VAC)	100-240VAC+10%-15% (85 to 264VAC)	○	
Input frequency	50/60Hz ± 5%	50/60Hz ± 5%	○	
Input voltage distortion	Within 5%	Within 5%	○	
Max. input apparent power	105VA	130VA	△	Check the capacity when using a UPS.
Inrush current	20A within 8ms	20A within 8ms	○	
Rated output current	5VDC	5A	○	
	24VDC	–	–	
Overcurrent protection	5VDC	5.5A or more	○	
	24VDC	–	–	
Overvoltage protection	5VDC	5.5 to 6.5V	○	
	24VDC	–	–	
Efficiency	65% or more	70% or more	○	
Power indicator	LED indication (Turns on when 5VDC is output.)	LED indication (normal: on (green), error: off)	○	
Fuse	Built-in (unchangeable)	Built-in (unchangeable)	○	
Terminal screw size	M3.5 × 7	M3.5 screws	○	
Applicable wire size	0.75 to 2mm ²	0.75 to 2mm ²	○	
Applicable solderless terminal	RAV1.25-3.5, RAV2-3.5	RAV1.25-3.5, RAV2-3.5	○	
Applicable tightening torque	59 to 88N·cm	66 to 89N·cm	△	Tighten within the applicable tightening torque.
External dimensions	130(H) × 55(W) × 93.6(D)mm (51.2(H) × 2.17(W) × 36.9(D) inches)	98(H) × 55.2(W) × 90(D)mm (3.86(H) × 2.33(W) × 3.54(D) inches)	△	Wiring space is narrower.
Weight	0.60kg	0.40kg	○	
Allowable momentary power failure period	Within 20ms	Within 20ms	○	
Noise immunity	<ul style="list-style-type: none"> • By noise simulator of 1500Vp-p noise voltage, 1μs noise width, and 25 to 60Hz noise frequency • Noise voltage IEC801-4-2kV 	<ul style="list-style-type: none"> • By noise simulator of 1500Vp-p noise voltage, 1μs noise width, and 25 to 60Hz noise frequency • Noise voltage IEC61000-4-4, 2kV 	○	
Withstand voltage	Between batch inputs and LG and batch outputs and FG 2830VAC rms/3 cycles (2000m (6562 ft.))	Between batch inputs and LG and batch outputs and FG 2830VAC rms/3 cycles (2000m (6562 ft.))	○	
Insulation resistance	Between batch inputs and LG and batch outputs and FG 10MΩ or more with the 500VDC insulation resistance tester	<ul style="list-style-type: none"> • Between batch inputs and LG and batch outputs and FG • Between all inputs and LG • Between all outputs and FG 10MΩ or more with the 500VDC insulation resistance tester	○	
Accessory	None	None	–	

(2) Specifications comparison between A1S61PN and Q61SP

○: Compatible, △: Partially changed ×: Incompatible

Specifications		A1S61PN	Q61SP	Compat- ibility	Precautions for replacement
Input power supply		100-240VAC+10%-15% (85 to 264VAC)	100-240VAC+10%-15% (85 to 264VAC)	○	
Input frequency		50/60Hz ± 5%	50/60Hz ± 5%	○	
Input voltage distortion		Within 5%	Within 5%	○	
Max. input apparent power		105VA	40VA	○	
Inrush current		20A within 8ms	20A within 8ms	○	
Rated output current	5VDC	5A	2A	△	The Q61SP can be used with the slim type main base unit only. Check the current consumption of entire system.
	24VDC	–	–	–	
Overcurrent protection	5VDC	5.5A or more	2.2A or more	○	Although the current value differs, the rated output is within +10% difference and the specifications are the same.
	24VDC	–	–	–	
Overvoltage protection	5VDC	5.5 to 6.5V	5.5 to 6.5V	○	
	24VDC	–	–	–	
Efficiency		65% or more	70% or more	○	
Power indicator		LED indication (Turns on when 5VDC is output.)	LED indication (normal: on (green), error: off)	○	
Fuse		Built-in (unchangeable)	Built-in (unchangeable)	○	
Terminal screw size		M3.5 × 7	M3.5 screws	○	
Applicable wire size		0.75 to 2mm ²	0.75 to 2mm ²	○	
Applicable solderless terminal		RAV1.25-3.5, RAV2-3.5	RAV1.25-3.5, RAV2-3.5	○	
Applicable tightening torque		59 to 88N·cm	66 to 89N·cm	△	Tighten within the applicable tightening torque.
External dimensions		130(H) × 55(W) × 93.6(D)mm (51.2(H) × 2.17(W) × 36.9(D) inches)	98(H) × 27.4(W) × 104(D)mm (3.86(H) × 1.08(W) × 4.09(D) inches)	△	Wiring space is narrower.
Weight		0.60kg	0.18kg	○	
Allowable momentary power failure period		Within 20ms	Within 20ms	○	
Noise immunity		<ul style="list-style-type: none"> • By noise simulator of 1500Vp-p noise voltage, 1μs noise width, and 25 to 60Hz noise frequency • Noise voltage IEC801-4-2kV 	<ul style="list-style-type: none"> • By noise simulator of 1500Vp-p noise voltage, 1μs noise width, and 25 to 60Hz noise frequency • Noise voltage IEC61000-4-4, 2kV 	○	
Withstand voltage		Between batch inputs and LG and batch outputs and FG 2830VAC rms/3 cycles (2000m (6562 ft.))	Between batch inputs and LG and batch outputs and FG 2830VAC rms/3 cycles (2000m (6562 ft.))	○	
Insulation resistance		Between batch inputs and LG and batch outputs and FG 10MΩ or more with the 500VDC insulation resistance tester	<ul style="list-style-type: none"> • Between batch inputs and LG and batch outputs and FG • Between all inputs and LG • Between all outputs and FG 10MΩ or more with the 500VDC insulation resistance tester	○	
Accessory		None	None	–	

(3) Specifications comparison between A1S62PN and Q62P

○: Compatible, △: Partially changed ×: Incompatible

Specifications	A1S62PN	Q62P	Compat- ibility	Precautions for replacement
Input power supply	100-240VAC+10%-15% (85 to 264VAC)	100-240VAC+10%-15% (85 to 264VAC)	○	
Input frequency	50/60Hz ± 5%	50/60Hz ± 5%	○	
Input voltage distortion	Within 5%	Within 5%	○	
Max. input apparent power	105VA	105VA	○	
Inrush current	20A within 8ms	20A within 8ms	○	
Rated output current	5VDC	3A	○	
	24VDC	0.6A	○	
Overcurrent protection	5VDC	3.3A or more	○	
	24VDC	0.66A or more	○	
Overvoltage protection	5VDC	5.5 to 6.5V	○	
	24VDC	–	–	
Efficiency	65% or more	65% or more	○	
Power indicator	LED indication (Turns on when 5VDC is output.)	LED indication (normal: on (green), error: off)	○	
Fuse	Built-in (unchangeable)	Built-in (unchangeable)	○	
Terminal screw size	M3.5 × 7	M3.5 screws	○	
Applicable wire size	0.75 to 2mm ²	0.75 to 2mm ²	○	
Applicable solderless terminal	RAV1.25-3.5, RAV2-3.5	RAV1.25-3.5, RAV2-3.5	○	
Applicable tightening torque	59 to 88N·cm	66 to 89N·cm	△	Tighten within the applicable tightening torque.
External dimensions	130(H) × 55(W) × 93.6(D)mm (51.2(H) × 2.17(W) × 36.9(D) inches)	98(H) × 55.2(W) × 90(D)mm (3.86(H) × 2.33(W) × 3.54(D) inches)	△	Wiring space is narrower.
Weight	0.60kg	0.39kg	○	
Allowable momentary power failure period	Within 20ms	Within 20ms	○	
Noise immunity	<ul style="list-style-type: none"> • By noise simulator of 1500Vp-p noise voltage, 1μs noise width, and 25 to 60Hz noise frequency • Noise voltage IEC801-4-2kV 	<ul style="list-style-type: none"> • By noise simulator of 1500Vp-p noise voltage, 1μs noise width, and 25 to 60Hz noise frequency • Noise voltage IEC61000-4-4, 2kV 	○	
Withstand voltage	Between batch inputs and LG and batch outputs and FG 2830VAC rms/3 cycles (2000m (6562 ft.))	Between batch inputs and LG and batch outputs and FG 2830VAC rms/3 cycles (2000m (6562 ft.))	○	
Insulation resistance	Between batch inputs and LG and batch outputs and FG 10MΩ or more by 500VDC insulation resistance tester	<ul style="list-style-type: none"> • Between batch inputs and LG and batch outputs and FG • Between all inputs and LG • Between all outputs and FG 10MΩ or more by 500VDC insulation resistance tester	○	
Accessory	None	None	–	

(4) Specifications comparison between A1S63P and Q63P

○: Compatible, △: Partially changed ×: Incompatible

Specifications	A1S63P	Q63P	Compat- ibility	Precautions for replacement
Input power supply	24VDC+30%-35% (15.6 to 31.2VDC)	24VDC+30%-35% (15.6 to 31.2VDC)	○	
Input frequency	—	—	—	
Input voltage distortion	—	—	—	
Max. input apparent	41W	45W	○	
Inrush current	81A within 1ms	100A within 1ms at 24VDC input	○	
Rated output current	5VDC	5A	○	
	24VDC	—	—	
Overcurrent protection	5VDC	5.5A or more	○	
	24VDC	—	—	
Overvoltage protection	5VDC	5.5 to 6.5V	○	
	24VDC	—	—	
Efficiency	65% or more	70% or more	○	
Power indicator	LED indication (Turns on when 5VDC is output.)	LED indication (normal: on (green), error: off)	○	
Fuse	Built-in (unchangeable)	Built-in (unchangeable)	○	
Terminal screw size	M3.5 ×7	M3.5 screws	○	
Applicable wire size	0.75 to 2mm ²	0.75 to 2mm ²	○	
Applicable solderless terminal	RAV1.25-3.5, RAV2-3.5	RAV1.25-3.5, RAV2-3.5	○	
Applicable tightening torque	59 to 88N·cm	66 to 89N·cm	△	Tighten within the applicable tightening torque.
External dimensions	130(H) × 55(W) × 93.6(D)mm (51.2(H) × 2.17(W) × 36.9(D) inches)	98(H) × 55.2(W) × 90(D)mm (3.86(H) × 2.33(W) × 3.54(D) inches)	△	Wiring space is narrower.
Weight	0.50kg	0.33kg	○	
Allowable momentary power failure period	Within 10ms (24VDC or more)	Within 10ms at 24VDC input	○	
Noise immunity	By noise simulator of 500Vp-p noise voltage, 1μs noise width, and 25 to 60Hz noise frequency	By noise simulator of 500Vp-p noise voltage, 1μs noise width, and 25 to 60Hz noise frequency	○	
Withstand voltage	Between primary and 5VDC 500VAC	Between batch inputs and LG and batch outputs and FG 500VAC for one minute	○	
Insulation resistance	Between batch inputs and LG and batch outputs and FG 10MΩ or more by 500VDC insulation resistance tester	<ul style="list-style-type: none"> • Between batch inputs and LG and batch outputs and FG • Between all inputs and LG • Between all outputs and FG 10MΩ or more by 500VDC insulation resistance tester	○	
Accessory	None	None	—	

(5) Specifications comparison between A1SJHCPU (power supply part) and Q00UJCPU/ Q00JCPU (power supply part)

○: Compatible, △: Partially changed ×: Incompatible

Specifications	A1SJHCPU (power supply part)	Q00JCPU/Q00UJCPU (power supply part)	Compat- ibility	Precautions for replacement
Input power supply	100-120VAC+10%-15% (85 to 132VAC)	100-240VAC+10%-15% (85 to 264VAC)	○	
	200-240VAC+10%-15% (170 to 264VAC)			
Input frequency	50/60Hz ± 3%	50/60Hz ± 5%	○	
Input voltage distortion	Within 5%	Within 5%	○	
Max. input apparent power	100VA	105VA	△	Check the capacity when using a UPS.
Inrush current	20A within 8ms	40A within 8ms	○	
Rated output current	5VDC	3A	○	
	24VDC	—	—	
Overcurrent protection	5VDC	3.3A or more	○	
	24VDC	—	—	
Overvoltage protection	5VDC	5.5 to 6.5V	○	
	24VDC	—	—	
Efficiency	65% or more	65% or more	○	
Power indicator	LED indication (Turns on when 5VDC is output.)	LED indication (normal: on (green), error: off)	○	
Fuse	None	Built-in (unchangeable)	○	
Terminal screw size	M3.5 × 8	M3.5 × 7	△	The screw length is shorter.
Applicable wire size	0.3 to 2mm ²	0.75 to 2mm ²	○	
Applicable solderless terminal	RAV1.25-3.5, RAV2-3.5	RAV1.25-3.5, RAV2-3.5	○	
Applicable tightening torque	59 to 88N·cm	66 to 89N·cm	△	Tighten within the applicable tightening torque.
External dimensions	130(H) × 330(W) × 82(D)mm (51.2(H) × 13.0(W) × 3.23(D) inches)	98(H) × 245(W) × 98(D)mm (3.86(H) × 9.65(W) × 3.86(D) inches)	△	Wiring space is narrower.
Weight	7.00kg	0.66kg	○	
Allowable momentary power failure period	Within 20ms (100VAC or more)	Within 20ms (100VAC or more)	○	
Noise immunity	<ul style="list-style-type: none"> • By noise simulator of 1500Vp-p noise voltage, 1μs noise width, and 25 to 60Hz noise frequency • Noise voltage IEC801-4-2kV 	<ul style="list-style-type: none"> • By noise simulator of 1500Vp-p noise voltage, 1μs noise width, and 25 to 60Hz noise frequency • Noise voltage IEC61000-4-4, 2kV 	○	
Withstand voltage	Between batch inputs and LG and batch outputs and FG 2830VAC rms/3 cycles (2000m (6562 ft.))	Between batch inputs and LG and batch outputs and FG 2830VAC rms/3 cycles (2000m (6562 ft.))	○	
Insulation resistance	Between batch inputs and LG and batch outputs and FG 10MΩ or more with the 500VDC insulation resistance tester	<ul style="list-style-type: none"> • Between batch inputs and LG and batch outputs and FG • Between all inputs and LG • Between all outputs and FG 10MΩ or more with the 500VDC insulation resistance tester	○	
Accessory	None	None	-	

4.3 Precautions for Power Supply Module Replacement

- (1) Current consumption differs between the Q series and AnS series modules. Select the power supply module with the result of calculating the current consumption of entire system.
- (2) Input power supply of the Q61P and Q62P is wide range type applicable to 100 to 200VAC.
The power supply can be used for operating voltage of both 100VAC and 200VAC.
- (3) The large-capacity type power supply Q64PN (8.5A) for the Q series is also available. It is recommended to use it when larger current capacity is necessary.

5 REPLACEMENT OF BASE UNIT AND EXTENSION CABLE

5.1 List of Alternative Models of Base Unit and Extension Cable

5.1.1 List of alternative models of base unit

AnS/QnAS series model		Q series alternative model		
Product	Model	Model	Remarks (restrictions)	
Main base unit* ¹	A1S32B	Q32SB	An extension base unit can be connected.→ cannot be connected.	
		Q33B		
	A1S33B	Q33SB	An extension base unit can be connected.→ cannot be connected.	
		Q33B		
		Q35SB	An extension base unit can be connected.→ cannot be connected.	
	A1S35B	Q35B		
	A1S38B	Q38B		
	A1S38HB	Q38B		
A1S38HBEU	Q38B			
Extension base unit	Type requiring no power supply module	A1S52B	Q52B	
		A1S55B	Q55B	
		A1S58B	Q55B	Q55B × 2 units Number of I/O slots: 8 slots → 5 slots × 2 units
			Q68B	The power supply module must be mounted.
		A52B	Q52B	
		A55B	Q55B	
	Type requiring power supply module	A58B	Q55B	Q55B × 2 units Number of I/O slots: 8 slots → 5 slots × 2 units
			Q68B	The power supply module must be mounted.
		-	Q63B	
		A1S65B	Q65B	
		A1S68B	Q68B	
		A62B	Q63B	Number of I/O slots: 2 slots → 3 slots
		A65B	Q65B	
A68B	Q68B			
A68B-UL	Q68B			

*1 The A1S3□B has extension cable connectors on its both sides.

5.1.2 List of alternative models of AnS size Q series large type base unit

AnS/QnAS series model		Q series alternative model	
Product	Model	Model	Remarks (restrictions)
Extension cable *1	A1S35B	Q35BLS	
		Q35BLS-D	DIN rail mounting type
	A1S38B	Q38BLS	
		Q38BLS-D	DIN rail mounting type
Extension base unit	Type requiring power supply module	A1S65B	
		Q65BLS	
	A1S68B	Q65BLS-D	DIN rail mounting type
		Q68BLS	
	Type requiring no power supply module	A1S55B	
		Q55BLS	
	Q55BLS-D	DIN rail mounting type	

*1 The A1S3□B has extension cable connectors on its both sides.

5.1.3 List of alternative models of extension cable

AnS/QnAS series model		Q series alternative model	
Product	Model	Model	Remarks (restrictions)
Extension cable *1	A1SC01B	QC05B	Cable length: 0.055m → 0.45m
	A1SC03B	QC05B	Cable length: 0.33m → 0.45m
	A1SC07B	QC12B	Cable length: 0.7m → 1.2m
	A1SC12B	QC12B	Cable length: 1.2m
	A1SC30B	QC30B	Cable length: 3.0m
	A1SC60B	QC100B	Cable length: 6.0m → 10.0m
	A1SC05NB	QC05B	Cable length: 0.45m
	A1SC07NB	QC06B	Cable length: 0.7m → 0.6m
	A1SC30NB	QC30B	Cable length: 3.0m
	A1SC50NB	QC50B	Cable length: 5.0m

*1 Select extension cables according to the installation method of the extension base unit.

Point

For details of replacing extension base unit and extension cable when using A/QnA series extension base unit, please refer to the following manual.

Transition from MELSEC-A/QnA (Large Type) Series to Q Series Handbook (Fundamentals)

L08043ENG

5.2 Comparison of Base Unit and Extension Cable Specifications

5.2.1 Comparison of base unit specifications

(1) Main base unit

(a) Comparison between A1S32B and Q32SB

Item	Model		Precautions for replacement
	AnS/QnAS series	Q series	
	A1S32B	Q32SB	
Number of mountable I/O modules	2 modules can be mounted.		For precautions for replacement, refer to Section 5.3.1. When using the upgrade tool (base adapter) with existing mounting holes, use the Q33B. For extension connection, use a main base unit supporting the connection.
Extendability	An extension base unit can be connected.	An extension base unit cannot be connected.	
Internal current consumption (5VDC)	-	0.09A	
Mounting hole size	φ6 bell-shaped hole (For M5 screw)	M4 screw hole or φ4.5 hole (For M4 screw)	
External dimensions	130(H) × 220(W) × 28(D)mm (5.12(H) × 8.66(W) × 1.10(D) inches)	98(H) × 114(W) × 18.5(D)mm (3.86(H) × 4.49(W) × 0.73(D) inches)	
Panel installation dimensions	200 × 110mm (7.87 × 4.33 inches)	101 × 80mm (3.98 × 3.15 inches)	

(b) Comparison between A1S33B and Q33SB

Item	Model		Precautions for replacement
	AnS/QnAS series	Q series	
	A1S33B	Q33SB	
Number of mountable I/O modules	3 modules can be mounted.		For precautions for replacement, refer to Section 5.3.1. When using the upgrade tool (base adapter) with existing mounting holes, use the Q33B. For extension unit connection, use a main base unit supporting the connection.
Extendability	An extension base unit can be connected.	An extension base unit cannot be connected.	
Internal current consumption (5VDC)	-	0.11A	
Mounting hole size	φ6 bell-shaped hole (For M5 screw)	M4 screw hole or φ4.5 hole (For M4 screw)	
External dimensions	130(H) × 255(W) × 28(D)mm (5.12(H) × 10.04(W) × 1.10(D) inches)	98(H) × 142(W) × 18.5(D)mm (3.86(H) × 5.59(W) × 0.73(D) inches)	
Panel installation dimensions	235 × 110mm (9.25 × 4.33 inches)	129 × 80mm (5.08 × 3.15 inches)	

(c) Comparison between A1S33B and Q33B

Item	Model		Precautions for replacement
	AnS/QnAS series	Q series	
	A1S33B	Q33B	
Number of mountable I/O modules	3 modules can be mounted.		For precautions for replacement, refer to Section 5.3.1. For extension connection, use a main base unit supporting the connection. The upgrade tool (base adapter) with existing mounting holes is available.
Extendability	An extension base unit can be connected.		
Internal current consumption (5VDC)	-	0.11A	
Mounting hole size	φ6 bell-shaped hole (For M5 screw)	M4 screw hole or φ4.5 hole (For M4 screw)	
External dimensions	130(H) × 255(W) × 28(D)mm (5.12(H) × 10.04(W) × 1.10(D) inches)	98(H) × 189(W) × 44.1(D)mm (3.86(H) × 7.44(W) × 1.74(D) inches)	
Panel installation dimensions	235 × 110mm (9.25 × 4.33 inches)	169 × 80mm (6.65 × 3.15 inches)	

(d) Comparison between A1S35B and Q35SB

Item	Model		Precautions for replacement
	AnS/QnAS series	Q series	
	A1S35B	Q35SB	
Number of mountable I/O modules	5 modules can be mounted.		For precautions for replacement, refer to Section 5.3.1. When using the upgrade tool (base adapter) with existing mounting holes, use the Q35B. For extension connection, use a main base unit supporting the connection.
Internal current consumption (5VDC)	-	0.10A	
Extendability	An extension base unit can be connected.	An extension base unit cannot be connected.	
Mounting hole size	φ6 bell-shaped hole (For M5 screw)	M4 screw hole or φ4.5 hole (For M4 screw)	
External dimensions	130(H) × 325(W) × 28(D)mm (5.12(H) × 12.80(W) × 1.10(D) inches)	98(H) × 197.5(W) × 18.5(D)mm (3.86(H) × 7.78(W) × 0.73(D) inches)	
Panel installation dimensions	305 × 110mm (12.00 × 4.33 inches)	184.5 × 80mm (7.26 × 3.15 inches)	

(e) Comparison between A1S35B and Q35B

Item	Model		Precautions for replacement
	AnS/QnAS series	Q series	
	A1S35B	Q35B	
Number of mountable I/O modules	5 modules can be mounted.		For precautions for replacement, refer to Section 5.3.1. The upgrade tool (base adapter) with existing mounting holes is available.
Extendability	An extension base unit can be connected.		
Internal current consumption (5VDC)	-	0.11A	
Mounting hole size	φ6 bell-shaped hole (For M5 screw)	M4 screw hole or φ4.5 hole (For M4 screw)	
External dimensions	130(H) × 325(W) × 28(D)mm (5.12(H) × 12.80(W) × 1.10(D) inches)	98(H) × 245(W) × 44.1(D)mm (3.86(H) × 9.65(W) × 1.74(D) inches)	
Panel installation dimensions	305 × 110mm (12.00 × 4.33 inches)	224.5 × 80mm (8.84 × 3.15 inches)	

(f) Comparison between A1S38B/A1S38HB/A1S38HBEU and Q38B

Item	Model		Precautions for replacement
	AnS/QnAS series	Q series	
	A1S38B/A1S38HB/ A1S38HBEU	Q38B	
Number of mountable I/O modules	8 modules can be mounted.		For precautions for replacement, refer to Section 5.3.1. The upgrade tool (base adapter) with existing mounting holes is available.
Extendability	An extension base unit can be connected.		
Internal current consumption (5VDC)	-	0.12A	
Mounting hole size	φ6 bell-shaped hole (For M5 screw)	M4 screw hole or φ4.5 hole (For M4 screw)	
External dimensions	130(H) × 430(W) × 28(D)mm (5.12(H) × 16.93(W) × 1.10(D) inches)	98(H) × 328(W) × 44.1(D)mm (3.86(H) × 12.91(W) × 1.74(D) inches)	
Panel installation dimensions	410 × 110mm (16.14 × 4.33 inches)	308 × 80mm (12.13 × 3.15 inches)	

(g) Comparison between A1SJHCPU and Q00UJCPU (Main base unit are integrated.)

Item	Model		Precautions for replacement
	AnS/QnAS series	Q series	
	A1SJHCPU	Q00UJCPU	
Number of mountable I/O modules	5 modules can be mounted.		For precautions for replacement, refer to Section 5.3.1. The upgrade tool (base adapter) with existing mounting holes is available.
Extendability	An extension base unit can be connected.		
Internal current consumption (5VDC)	-	0.12A	
Mounting hole size	φ6 bell-shaped hole (For M5 screw)	M4 screw hole or φ4.5 hole (For M4 screw)	
External dimensions	130(H) × 330(W) × 82(D)mm (5.12(H) × 13.0(W) × 3.23(D) inches)	98(H) × 244.4(W) × 98(D)mm (3.86(H) × 9.62(W) × 3.86(D) inches)	
Panel installation dimensions	310 × 110mm (12.2 × 4.33 inches)	244.4 × 80mm (9.62 × 3.15 inches)	

(2) Extension base unit (type requiring no power supply module)

(a) Comparison between A1S52B(-S1) and Q52B

Item	Model		Precautions for replacement
	AnS/QnAS series	Q series	
	A1S52B(-S1)	Q52B	
Number of mountable I/O modules	2 modules can be mounted.		For precautions for replacement, refer to Section 5.3.1. The upgrade tool (base adapter) with existing mounting holes is available.
Extendability	An extension base unit cannot be connected.	An extension base unit can be connected.	
Internal current consumption (5VDC)	-	0.08A	
Mounting hole size	φ6 bell-shaped hole (For M5 screw)	M4 screw hole or φ4.5 hole (For M4 screw)	
External dimensions	130(H) × 155(W) × 28(D)mm (5.12(H) × 6.10(W) × 1.10(D) inches)	98(H) × 106(W) × 44.1(D)mm (3.86(H) × 4.17(W) × 1.74(D) inches)	
Panel installation dimensions	135 × 110mm (5.31 × 4.33 inches)	83.5 × 80mm (3.29 × 3.15 inches)	

(b) Comparison between A1S55B(-S1) and Q55B

Item	Model		Precautions for replacement
	AnS/QnAS series	Q series	
	A1S55B(-S1)	Q55B	
Number of mountable I/O modules	5 modules can be mounted.		For precautions for replacement, refer to Section 5.3.1. The upgrade tool (base adapter) with existing mounting holes is available.
Extendability	An extension base unit cannot be connected.	An extension base unit can be connected.	
Internal current consumption (5VDC)	-	0.10A	
Mounting hole size	φ6 bell-shaped hole (For M5 screw)	M4 screw hole or φ4.5 hole (For M4 screw)	
External dimensions	130(H) × 260(W) × 28(D)mm (5.12(H) × 10.24(W) × 1.10(D) inches)	98(H) × 189(W) × 44.1(D)mm (3.86(H) × 7.44(W) × 1.74(D) inches)	
Panel installation dimensions	240 × 110mm (9.45 × 4.33 inches)	167 × 80mm (6.57 × 3.15 inches)	

(c) Comparison between A1S58B(-S1) and two Q55Bs

Item	Model		Precautions for replacement
	AnS/QnAS series	Q series	
	A1S58B(-S1)	Q55B × 2	
Number of mountable I/O modules	8 modules can be mounted.	5 modules × 2 units can be mounted.	For precautions for replacement, refer to Section 5.3.1.
Extendability	An extension base unit cannot be connected.	An extension base unit can be connected.	
Internal current consumption (5VDC)	-	0.11A × 2 units	
Mounting hole size	φ6 bell-shaped hole (For M5 screw)	M4 screw hole or φ4.5 hole (For M4 screw)	
External dimensions	130(H) × 365(W) × 28(D)mm (5.12(H) × 14.37(W) × 1.10(D) inches)	(98(H) × 189(W) × 44.1(D)mm) × 2 ((3.86(H) × 7.44(W) × 1.74(D) inches) × 2)	
Panel installation dimensions	345 × 110mm (13.58 × 4.33 inches)	(167 × 80mm) × 2 ((6.57 × 3.15 inches) × 2)	

(d) Comparison between A1S58B and Q68B (type requiring power supply module)

Item	Model		Precautions for replacement
	AnS/QnAS series	Q series	
	A1S58B	Q68B	
Number of mountable I/O modules	8 modules can be mounted.		<ul style="list-style-type: none"> • The power supply module must be mounted. • For precautions for replacement, refer to Section 5.3.1. The upgrade tool (base adapter) with existing mounting holes is available.
Extendability	An extension base unit cannot be connected.	An extension base unit can be connected.	
Internal current consumption (5VDC)	-	0.12A	
Mounting hole size	φ6 bell-shaped hole (For M5 screw)	M4 screw hole or φ4.5 hole (For M4 screw)	
External dimensions	130(H) × 365(W) × 28(D)mm (5.11(H) × 14.37(W) × 1.10(D) inches)	98(H) × 328(W) × 44.1(D)mm (3.86(H) × 12.91(W) × 1.74(D) inches)	
Panel installation dimensions	345 × 110mm (13.58 × 4.33 inches)	306 × 80mm (12.05 × 3.15 inches)	

(3) Extension base unit (type requiring power supply module)

(a) Comparison between A1S65B(-S1) and Q65B

Item	Model		Precautions for replacement
	AnS/QnAS series	Q series	
	A1S65B(-S1)	Q65B	
Number of mountable I/O modules	5 modules can be mounted.		For precautions for replacement, refer to Section 5.3.1. The upgrade tool (base adapter) with existing mounting holes is available.
Extendability	An extension base unit cannot be connected.	An extension base unit can be connected.	
Internal current consumption (5VDC)	-	0.11A	
Mounting hole size	φ6 bell-shaped hole (For M5 screw)	M4 screw hole or φ4.5 hole (For M4 screw)	
External dimensions	130(H) × 315(W) × 28(D)mm (5.12(H) × 12.40(W) × 1.10(D) inches)	98(H) × 245(W) × 44.1(D)mm (3.86(H) × 9.65(W) × 1.74(D) inches)	
Panel installation dimensions	295 × 110mm (11.61 × 4.33 inches)	222.5 × 80mm (8.76 × 3.15 inches)	

(b) Comparison between A1S68B(-S1) and Q68B

Item	Model		Precautions for replacement
	AnS/QnAS series	Q series	
	A1S68B(-S1)	Q68B	
Number of mountable I/O modules	8 modules can be mounted.		For precautions for replacement, refer to Section 5.3.1. The upgrade tool (base adapter) with existing mounting holes is available.
Extendability	An extension base unit cannot be connected.	An extension base unit can be connected.	
Internal current consumption (5VDC)	-	0.12A	
Mounting hole size	φ6 bell-shaped hole (For M5 screw)	M4 screw hole or φ4.5 hole (For M4 screw)	
External dimensions	130(H) × 420(W) × 28(D)mm (5.12(H) × 16.54(W) × 1.10(D) inches)	98(H) × 328(W) × 44.1(D)mm (3.86(H) × 12.91(W) × 1.74(D) inches)	
Panel installation dimensions	400 × 110mm (15.75 × 4.33 inches)	306 × 80mm (12.05 × 3.15 inches)	

5.2.2 Comparison of extension cable specifications

Item		Model			Precautions for replacement
		AnS/QnAS series		Q series	
		AnS main-AnS extension	AnS main-A extension		
Cable length	0.055m	A1SC01B	-	-	For precautions for replacement, refer to Section 5.3.1.
	0.33m	A1SC03B	-	-	
	0.45m	-	A1SC05NB	QC05B	
	0.6m	-	-	QC06B	
	0.7m	A1SC07B	A1SC07NB	-	
	1.2m	A1SC12B	-	QC12B	
	3.0m	A1SC30B	A1SC30NB	QC30B	
	5.0m	-	A1SC50NB	QC50B	
	6.0m	A1SC60B	-	-	
	10.0m	-	-	QC100B	

5.3 Precautions for Replacement of Base Unit and Extension Cable

5.3.1 Precautions for replacement of base unit

- (1) **When replacing the AnS/QnAS small type series base unit with the Q series, it is necessary to redo the mounting holes to fix the unit to a control panel, since the two series have different mounting hole size.**
- (2) **Installation method for the Q series base unit using the existing mounting hole**
 - (a) **Replacement with the Q series large type base unit (AnS series size)**

Reprocess of the mounting hole is not required, because the Q series large type base unit (AnS series size) and the existing AnS (small type) series base unit are the same dimensions.
 - (b) **Replacement with the upgrade tool (base adapter)**

When the Q series base unit is installed using the existing mounting hole, reprocess of the hole is not required by using the upgrade tool (base adapter) manufactured by Mitsubishi Electric Engineering Co., Ltd.
For the upgrade tool, please consult your local Mitsubishi Electric sales office or representative.
- (3) **Internal current consumption (5VDC)**

The Q series base unit consumes 5VDC internally as well as CPU modules and I/O modules. When the internal current consumption (5VDC) of entire system is calculated, consider the current consumption of the base unit.
- (4) **Extension base unit (type requiring no power supply module)**
 - (a) **Power supply module**

The extension base units (Q5□B and QA1S5□B) are supplied 5VDC by the power supply module on the main base unit. Therefore, select the rated output current (5VDC) of the power supply module on the main base unit so that 5VDC on the Q5□B and QA1S5□B is satisfied.
 - (b) **Voltage drop by an extension cable**

The voltage drop in an extension cable occurred, because the extension base units (Q5□B and QA1S5□B) are supplied 5VDC through the extension cable. For the voltage drop, refer to the QCPU User's Manual (Hardware Design, Maintenance and Inspection)

5.3.2 Precautions for replacement of extension cable

(1) Overall cable distance of extension cable

An extension cable can be used up to 13.2m (43.31ft.) for the Q series while it can be used up to 6.0m (19.68ft.) for the AnS/QnAS series.
 Select a cable optimum for the system.

(2) Extension cable

The AnS series main base unit has two extension connectors (right and left) and the A1SJHCPU has one extension connector (right). However, the Q series main base unit has one extension connector (left). When the main base unit and extension base unit are located as below, the existing cable length may be not enough. Consider the position in the control panel and select the cable which has the proper length.

- Configuration example when the base units are located to right and left

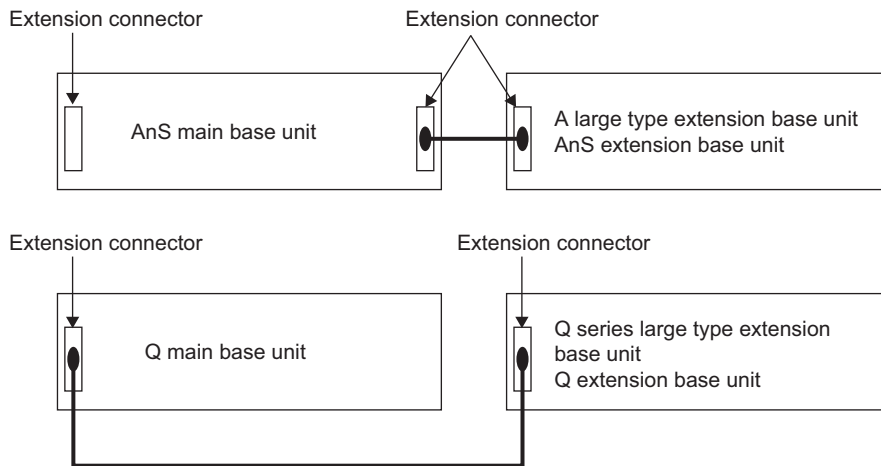

5.4 QA(1S) Extension Base Unit

When replacing the AnS/QnAS series CPU by the Q series using the QA(1S) extension base unit, A/ AnS/QnA/QnAS series-compatible module can be utilized without change.

5.4.1 QA(1S) extension base unit specifications

Item	Model					
	QA1S51B	QA1S65B	QA1S68B	QA65B	QA68B	
Number of mountable I/O modules	1	5	8	5	8	
Extendability	An extension base unit cannot be connected.	Mounting additional modules is possible.				
Applicable module	AnS series module			A series module		
Internal current consumption (5VDC)	0.12A	0.12A	0.11A	0.12A	0.12A	
Mounting hole size	M5 screw hole or ϕ 5.5 hole (For M5 screw)			M5 screw hole or ϕ 5.5 hole (For M5 screw)		
External dimensions	H	130mm (5.12 inches)			250mm (9.84 inches)	
	W	100mm	315mm (12.4 inches)	420mm (16.55 inches)	352mm (13.86 inches)	466mm (18.34 inches)
	D	50.7mm	51.2mm (2.02 inches)		46.6mm (1.83 inches)	
Weight	0.23kg	0.75kg	1.00kg	1.60kg	2.00kg	
Accessory	Mounting screw M5 \times 25 3 screws	Mounting screw M5 \times 25 4 screws			-	

5.4.2 Applicable QCPU

The following table shows CPU models that can use the QA(1S) extension base unit as an extension base unit for the QCPU.

CPU Model	Availability	
Universal model QCPU	All CPUs including High-speed Universal model QCPU	Usable*1
High Performance model QCPU	Q02CPU	Usable
	Q02HCPU	
	Q06HCPU	
	Q12HCPU	
	Q25HCPU	
Basic model QCPU	Q00CPU	Unusable
	Q01CPU	
	Q01CPU	
Process CPU	Q12PHCPU	Unusable
	Q25PHCPU	
Redundant CPU	Q12PRHCPU	Unusable
	Q25PRHCPU	

*1 When the QA(1S) extension base unit is used with the Universal model QCPU, use the Universal model QCPU with a serial number (first five digits) of "13102" or later.

5.4.3 Extension cable

Item	Model					
	QC05B	QC06B	QC12B	QC30B	QC50B	QC100B
Cable length	0.45m (1.48ft.)	0.6m (1.97ft.)	1.2m (3.94ft.)	3.0m (9.84ft.)	5.0m (16.40ft.)	10.0m (32.81ft.)
Weight	0.15kg	0.16kg	0.22kg	0.40kg	0.60kg	1.11kg

5.4.4 System configuration

This section explains the system configuration and precautions for use of the QA(1S)6□B and QA1S51B type extension base unit.

(1) Connection order of extension base units

When using the Q6□B, QA1S6□B, QA1S51B, and QA6□B together, connect them in the order of the Q6□B, QA1S6□B, QA1S51B, and QA6□B from the nearest position of the main base unit. The QA1S51B is not extendable. When the QA1S51B is used, the QA6□B cannot be used.

(2) Connection order of extension base units upon setting the extension stage number

To use extension base units, it is necessary to set extension stage numbers (1 to 7) with the stage number setting connector.

Set the extension stage number 1 to the connected extension base unit closest to the main base unit, and the following extension stage number (up to 7) to the following extension base units in the connected order.

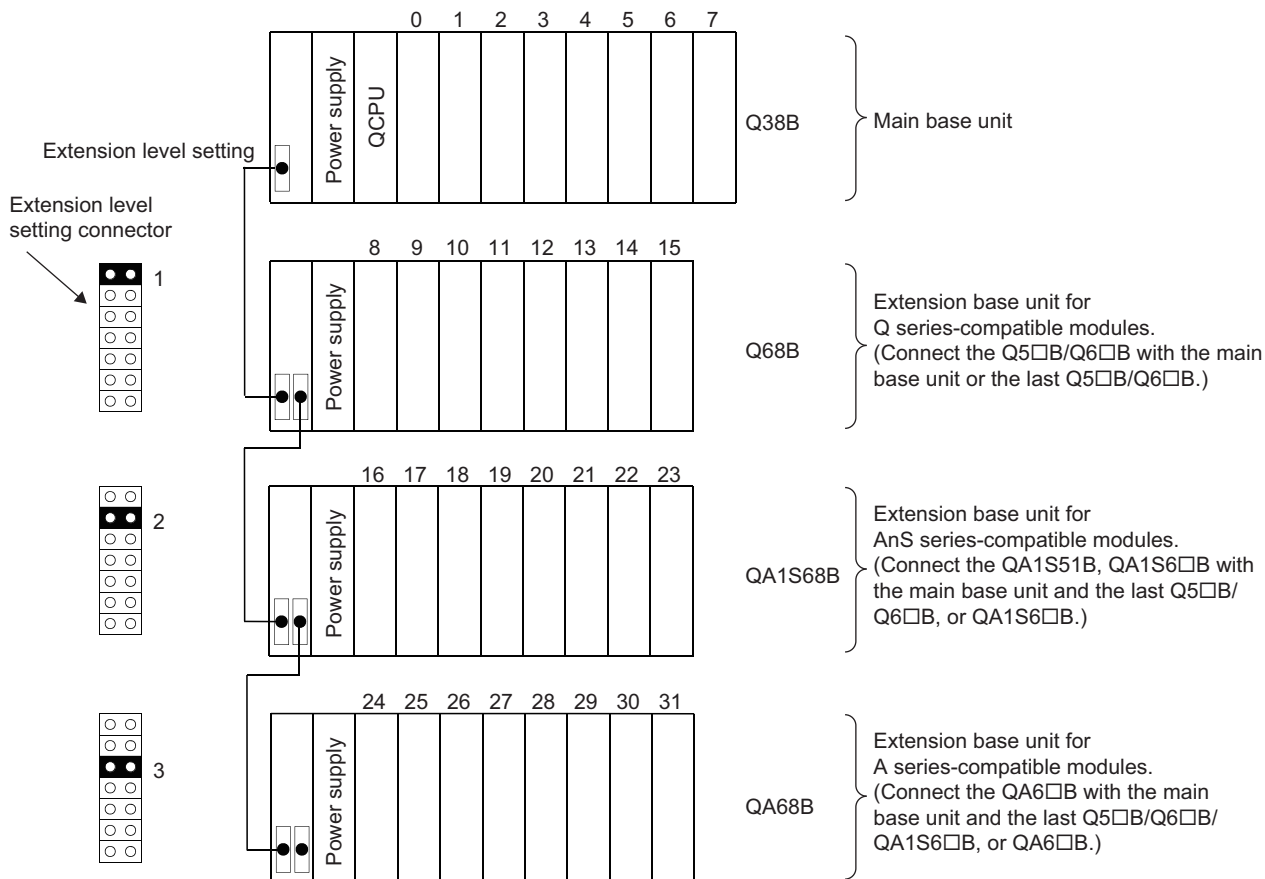

Remarks

- (1) Normal operations of the A series AC input module cannot be guaranteed if there is no base unit on which the A series power supply module is mounted.
Use the A series AC input module in either of the following configurations.
 - Mount the A series AC input module on the QA6□B or A6□B to which the QA6ADP is attached.
 - Mount the A series AC input module on the A5□B to which the QA6ADP is attached, or connect the QA6□B or A6□B to which the QA6ADP is attached as another extension base unit.
- (2) The extension base unit for large-sized A series with QA conversion adapter mounted and QA1S extension base unit cannot be used together. (When connecting the extension base unit with QA conversion adapter mounted, QA1S extension base unit cannot be connected.)
- (3) When the QA6□B is connected to a Q series extension base unit, the QA6□B and QA1S6□B are used together, or the QA1S51B is used, a GOT cannot be bus-connected.
However, when only the QA1S6□B is connected, a GOT can be bus-connected.

5.4.5 System equipment list

(1) QA1S extension base unit

The following table lists configurable devices that can be used with the QA1S51B or QA1S6□B extension base unit.

Product	Model				Remarks
Power supply module	A1S61PN,	A1S62PN,	A1S63P		
Input module	A1SX10,	A1SX10EU,	A1SX20,	A1SX20EU,	
	A1SX30,	A1SX40,	A1SX40-S1,	A1SX40-S2,	
	A1SX41,	A1SX41-S1,	A1SX41-S2,	A1SX42,	
	A1SX42-S1,	A1SX42-S2,	A1SX71,	A1SX80,	
	A1SX80-S1,	A1SX80-S2,	A1SX81,	A1SX81-S2,	
	A1SX82-S1,	A1SX42X			
Output module	A1SY10,	A1SY10EU,	A1SY14EU,	A1SY18A,	
	A1SY18AEU,	A1SY22,	A1SY28A,	A1SY40,	
	A1SY40P,	A1SY41,	A1SY41P,	A1SY42,	
	A1SY42P	A1SY50,	A1SY60,	A1SY60E,	
	A1SY68A,	A1SY71,	A1SY80,	A1SY81,	
	A1SY82,	A1S42Y			
I/O module	A1SH42,	A1SH42-S1,	A1SX48Y58,	A1SX48Y18	
High-speed counter module	A1SD61,	A1SD62,	A1SD62E,	A1SD62D,	*1
	A1SD62D-S1				
A/D converter module	A1S64AD,	A1S68AD			
D/A converter module	A1S62DA,	A1S68DAI,	A1S68DAV		
Analog I/O module	A1S63ADA,	A1S66ADA			
Temperature input module	A1S62RD3N,	A1S62RD4N,	A1S68TD		
Temperature control module	A1S62TCTT-S2,	A1S62TCRTBW-S2,	A1S64TCTRT,		
	A1S62TCRT-S4,	A1S62TCTTBW-S2,	A1S64TCTRTBW,		
	A1S64TCTT-S1,	A1S64TCTTBW-S1,			
	A1S64TCRT-S1,	A1S64TCRTBW-S1			
Pulse catch module	A1SP60				
Analog timer module	A1ST60				
Interrupt module	A1SI61				*3
Positioning module	A1SD70				
	A1SD75P1-S3,	A1SD75P2-S3,	A1SD75P3-S3		*1
	A1SD75M1,	A1SD75M2,	A1SD75M3		*1
MELSECNET/MINI-S3 master module	A1SJ71PT32-S3				*1
Computer Link module	A1SJ71UC24-R4				*2 *4
Intelligent communication module	A1SD51S				*2
MELSECNET, MELSECNET/B local station data link module	A1SJ71AP23Q,	A1SJ71AR23Q,	A1SJ71AT23BQ		
Position detection module	A1S62LS				
PC fault detection module	A1SS91				
Memory card interface module	A1SD59J-S2				
ID interface module	A1SD35ID1,	A1SD35ID2			*2
MELSEC-I/O LINK master module	A1SJ51T64				
B/NET interface module	A1SJ71B62-S3				
S-LINK master module	A1SJ71SL92N				
AS-i master module	A1SJ71AS92				
Blank cover	A1SG60				
Dummy module	A1SG62				

*1 The dedicated instructions in A/AnSQnA/QnAS series program are not applicable to the QCPU program. Replace them with the FROM/TO instructions.

*2 When using the QA6□B, up to six modules having the same product name can be mounted to the QA6□B.

*3 Only one interrupt module any of QI60, A1SI61, AI61, and AI61-S1 can be used.

*4 Only the multidrop link function can be used.
(The computer link function (dedicated protocols/non procedure) cannot be used.)

(2) QA extension base unit

The following table shows modules that can be used on the QA6□B extension base unit.

Product	Model				Remarks
Power supply module	A61P, A67P, A62PEU	A62P, A66P,	A63P, A68P,	A65P, A61PEU,	
Input module	AX10, AX21, AX40, AX42-S1, AX60-S1, AX80E, AX81-S3,	AX11, AX21EU, AX41, AX50, AX70, AX81, AX81B,	AX11EU, AX31, AX41-S1, AX50-S1, AX71, AX81-S1, AX82	AX20, AX31-S1, AX42, AX60, AX80, AX81-S2,	
Output module	AY10, AY11E, AY13E, AY22, AY40A, AY42-S1, AY50, AY60S, AY71, AY81,	AY10A, AY11AEU, AY13EU, AY23, AY41, AY42-S2, AY51, AY60E, AY72, AY81EP,	AY11, AY11EEU, AY15EU, AY40, AY41P, AY42-S3, AY51-S1, AY60EP, AY80, AY82EP	AY11A, AY13, AY20EU, AY40P, AY42, AY42-S4, AY60, AY70, AY80EP,	
I/O module	A42XY,	AH42			
High-speed counter module	AD61,	AD61S1			*1
A/D converter module	A68AD,	A68AD-S2,	A68ADN,	A616AD	
D/A converter module	A62DA, A616DAV,	A62DA-S1, A616DAI	A68DAV,	A68DAI-S1,	
Temperature-digital converter module	A68RD3, A60MXR,	A68RD4, A60MXT	A616TD,	A60MX,	
Interrupt module	AI61,	AI61-S1			*3
Positioning module	AD70, AD71S2,	AD70D, AD71S7,	AD71, AD72,	AD71S1, AD778M	
	AD75P1-S3,	AD75P2-S3,	AD75P3-S3		*1
	AD75M1,	AD75M2,	AD75M3		*1
MELSECNET/MINI-S3 master module	AJ71PT32-S3,	AJ71T32-S3			*1
Intelligent communication module	AD51-S3,	AD51H-S3			*2
Position detection module	A61LS,	A62LS-S5,	A63LS		
PC fault detection module	AS91				
Memory card interface module	AD59,	AD59-S1			
Supersonic linear scale interface module	A64BTL				
ID interface module	AJ71ID1-R4,	AJ71ID2-R4			*2
	AD32ID1,	AD32ID2			
MELSEC-I/OLINK module	AJ51T64				
B/NET interface module	AJ71B62-S3				
External failure diagnostics module	AD51FD-S3				
Voice output module	A11VC				
Vision sensor module	AS50VS,	AS50VS-GN			
Blanking module	AG60				
Dummy module	AG62				

*1 The dedicated instructions in QnA/A series program are not applicable to the QCPU program.
Replace them with the FROM/TO instructions.

*2 When the QA1S51B and QA1S6□B are used, up to six modules having the same product name can be mounted to the QA1S51B and QA1S6□B.

*3 Only one interrupt module any of QI60, A1SI61, AI61 and AI61-S1 can be used.

5.4.6 I/O address for the QA(1S) extension base unit

This section explains I/O address (I/O assignment) when using the QA(1S) extension base unit.

(1) Concept of I/O address when using the QA(1S) extension base unit

I/O address when using the QA(1S) extension base unit can be assigned to either of the following.

- (a) Assign the I/O address of the Q series module to the lowest address and assign that of the A series module to the Q series module I/O address + 1 or later.
- (b) Assign the I/O address of the A series module to the lowest address and assign that of the Q series module to the A series module I/O address + 1 or later.

☒ Point

- (1) I/O address can be assigned by either of the following address orders.

- (a) Q series module → A series module
- (b) A series module → Q series module

Note that the CPU module does not start due to an error if the address is assigned in the order of Q series module → A series module → Q series module and vice versa.

- (2) The QA(1S) extension base unit (QA1S51B, QA1S65B, QA1S68B, QA65B, QA68B) occupies I/O addresses for eight modules.
-

(2) I/O address assignment example

The following explains assignment example to modify the program at minimum by using the QA1S6□B extension base unit and utilizing the existing AnS series module without I/O address change.

(a) System configuration example

(Existing system configuration example)

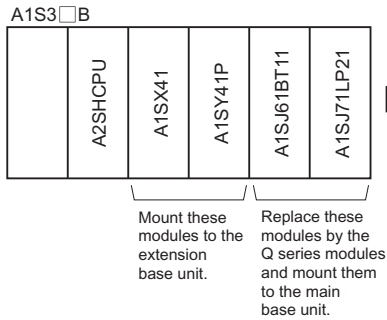

(System configuration example after replacement)

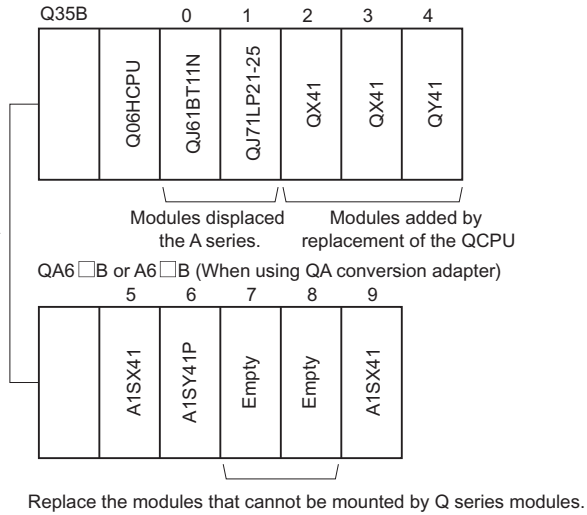

As the CC-Link master/local module, MELSECNET/10(H) network module cannot be utilized, replace them by QCPU-compatible modules.

(b) I/O assignment example of the parameter

(Q35B side)					(QA1S6□B side)					
		Type	Number of occupied points	Address		Model	Type	Number of occupied points	Address	
Main base unit	0	Intelligent	32 points	100	Extension base unit	5	A1SX41	Input	32 points	00
	1	Intelligent	32 points	120		6	A1SY41	Output	32 points	20
	2	Input	32 points	140		7		Empty	32 points	40
	3	Input	32 points	160		8		Empty	32 points	60
	4	Output	32 points	180		9	A1SX41	Input	32 points	80

The program can be utilized without changing the I/O address of the existing AnS series module by the I/O assignment above.

5.5 AnS Size Q Series Large Type Base Unit

When replacing the Ans/QnA series with the Q series, this product can be replaced by using the existing wiring on the installation space that is the same as existing installation space.

5.5.1 Specifications

(1) AnS size Q series large type main base unit

Item	Model				
	Q35BLS	Q38BLS	Q35BLS-D	Q38BLS-D	
Number of mountable I/O modules	5	8	5	8	
Extendability	Mounting additional stages is possible.				
Applicable module	Q series module				
Internal current consumption (5VDC)	0.11A	0.12A	0.11A	0.12A	
Mounting hole size	φ6 hole (For M5 screw)		-		
External dimensions	H	130mm		118mm	
	W	325mm	430mm	311mm	416mm
	D	53mm		48.5mm	
Weight	0.82kg	1.32kg	0.59kg	0.72kg	
DIN rail installation	Cannot be installed.		Can be installed.		

(2) AnS size Q series large type extension base unit (type requiring power supply module)

Item	Model				
	Q65BLS	Q68BLS	Q65BLS-D	Q68BLS-D	
Number of mountable I/O modules	5	8	5	8	
Extendability	Mounting additional stages is possible.				
Applicable module	Q series module				
Internal current consumption (5VDC)	0.11A	0.12A	0.11A	0.12A	
Mounting hole size	φ6 hole (For M5 screw)		-		
External dimensions	H	130mm		118mm	
	W	315mm	420mm	304mm	409mm
	D	53mm		48.5mm	
Weight	0.98kg	1.32kg	0.57kg	0.74kg	
DIN rail installation	Cannot be installed.		Can be installed.		

(3) AnS size Q series large type extension base unit (type requiring no power supply module)

Item	Model		
	Q55BLS-D	Q55BLS-D	
Number of mountable I/O modules	5		
Extendability	Mounting additional stages is possible.		
Applicable module	Q series module		
Internal current consumption (5VDC)	0.10A		
Mounting hole size	φ6 hole (For M5 screw)	-	
External dimensions	H	130mm	118mm
	W	260mm	248mm
	D	53mm	48.5mm
Weight	0.82kg	0.51kg	
DIN rail installation	Cannot be installed.	Can be installed.	

5.5.2 Applicable programmable controller

The following modules are mountable to the CPU slot on the AnS size Q series large type base unit. (The Basic model QCPU, Process CPU, Redundant CPU, and safety CPU are not mountable.)

- High Performance model QCPU
- Universal model QCPU (including High-speed Universal model QCPU)
The Q00UJCPU cannot be used.
- MELSECNET/H remote I/O module

5.5.3 Modules that cannot be mounted on the AnS size Q series large type base unit

This section describes the modules that cannot be mounted on the AnS size Q series large type base unit.

(1) Two-slot module

Example Such as Q64TCRTBW, Q64TCRTBWN, Q64TCTTBW, Q64TCTTBWN, QD70D4, QD70D8, QJ71LP21S-25, and QJ71GP21S-SX

(2) Module on which the AnS size Q series large type black cover cannot be attached

- Module whose height exceeds 98mm
- Module with a bracket on its top
- A module with a protrusion, such as a connector, on the bottom
- Module on which the Q7BAT-SET has been mounted

Example Module on which the Q66AD-DG, Q66DA-G, Q68AD-G, Q68RD3-G, Q68TD-G-H02, Q64AD2DA, QD75M1, QD75MH1, QD75M2, QD75MH2, QD75M4, or QD75MH4 has been mounted; or the QJ71WS96 on which the Q7BAT-SET has been mounted

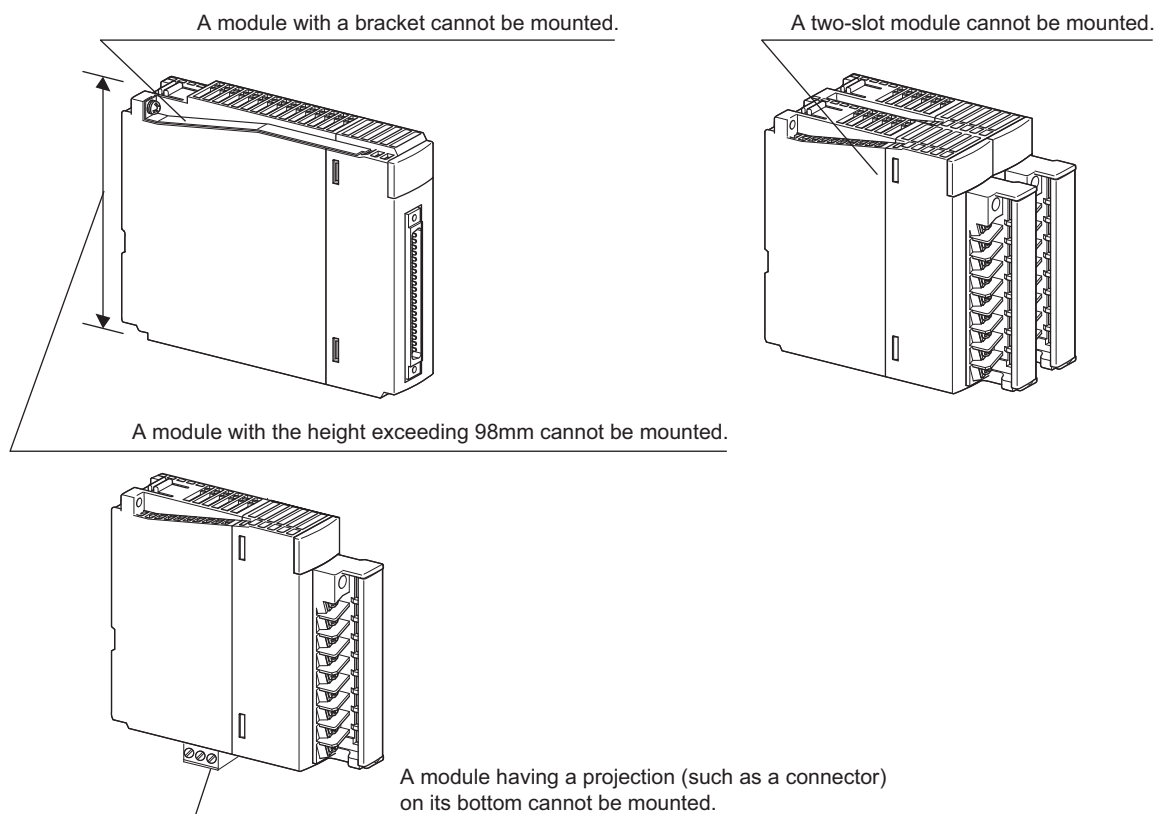

6 MEMORY AND BATTERY REPLACEMENT

6.1 List of Alternative Models for Memory

AnS/QnAS series models to be discontinued		Q series alternative models	
Product	Model	Model	Remarks (restrictions)
Memory cassette (E ² ROM)	A1SNMCA-2KE	Unnecessary	Program memory of the Universal model QCPU is a Flash ROM. Standard ROM can replace Basic model/High Performance model.
	A1SNMCA-8KE		
	A2SNMCA-30KE		
Memory cassette (EP-ROM)	A3NMCA-8KP		
Memory card (SRAM)	Q1MEM-64S	Unnecessary	Standard RAM can replace file register.*1
	Q1MEM-128S		
	Q1MEM-256S		
	Q1MEM-512S		
	Q1MEM-1MS		
	Q1MEM-2MS		
Memory card (SRAM+E ² ROM)	Q1MEM-64SE	Unnecessary	<ul style="list-style-type: none"> • Program memory of the Universal model QCPU is a Flash ROM. • Standard ROM can replace Basic model/High Performance model • Standard RAM can replace file register.*1
	Q1MEM-128SE		
	Q1MEM-256SE		
	Q1MEM-512SE		
	Q1MEM-1MSE		

*1 When the memory capacity of standard RAM is shortage, the memory card (SRAM) can be used.

- Q2MEM-1MBS
- Q2MEM-2MBS

6.2 Precautions for Memory and Battery Replacement

(1) Precaution for memory replacement

When multiple blocks of extension file registers are used or standard RAM memory space is insufficient, the SRAM card for the Q series is required.

(2) Precaution for battery replacement

The battery for the A series (A6BAT*) should be replaced with the one for Q series (Q6BAT, Q7BAT). (The Q6BAT is included in the Q series CPU as standard equipment.)

Refer to the users manual of each CPU module for battery life, since it varies depending on the type of CPU module and memory cassette.

* The A6BAT is not a model to be discontinued.

7 REPLACEMENT OF PROGRAM

This chapter describes replacement procedures and precautions for using programs and comments of the AnS/QnASCPU in the QCPU.

(1) Comparison between AnSCPU and QCPU

○: Compatible, △:Partially changed, ×: Incompatible

Item		AnSCPU specifications	QCPU specifications and precautions for replacement	Compat- ibility	Reference
Sequence program	Main	<ul style="list-style-type: none"> Main program is required. The SFC is dealt as the microcomputer program of main program. 	[Specification] <ul style="list-style-type: none"> Each program is dealt as one file. [Measure] <ul style="list-style-type: none"> Execute the file setting of PLC parameter. 	△	Section 7.7.10
	SFC				
Microcomputer program		<ul style="list-style-type: none"> A user-created microcomputer program and the microcomputer program of the utility package are available. 	[Specification] <ul style="list-style-type: none"> Creating microcomputer program is not applicable. [Measure] <ul style="list-style-type: none"> Replace the AnSCPU user-created microcomputer program with sequence program since the microcomputer program execution is not applicable. For utility packages instructions, correct them equivalent to the corresponding instructions of the QCPU. 	×	—
Instruction		<ul style="list-style-type: none"> Dedicated instructions for the AnA/ AnU CPU (LED instruction, etc.) are available. 	[Specification] <ul style="list-style-type: none"> With "Change PLC type", instructions are converted automatically except some instructions. [Measure] <ul style="list-style-type: none"> The instructions that cannot be converted are changed to SM1255 and SD1255 for QCPU, and SM999 and SD999 for the Basic model QCPU. Therefore, program modification is required. 	△	Section 7.2
File register		<ul style="list-style-type: none"> Storage area is reserved in a memory cassette. One block is set in 8 k points unit. 	[Specification] <ul style="list-style-type: none"> Data is stored in a standard RAM or memory card. One block is set in 32k points unit. [Measure] <ul style="list-style-type: none"> Execute the file setting of PLC parameter. 	△	Section 7.7.11

Item	AnSCPU specifications	QCPU specifications and precautions for replacement	Compatibility	Reference
Timer, Counter	<ul style="list-style-type: none"> • Timer and counter are processed with the END. 	<p>[Specification]</p> <ul style="list-style-type: none"> • Timer and counter are processed when executing an instruction. <p>[Measure]</p> <ul style="list-style-type: none"> • Review the programs since the processing timing differs between timer and counter. 	△	Section 7.7.4, Section 7.7.5
Parameter	<ul style="list-style-type: none"> • Parameters are dedicated for each CPU. 	<p>[Specification]</p> <ul style="list-style-type: none"> • Parameters are dedicated for each CPU. <p>[Measure]</p> <ul style="list-style-type: none"> • Check and re-set the parameters since specifications and functions differ between the two CPUs. 	△	Section 7.3
Special relay	<ul style="list-style-type: none"> • 256 points of M9000 to M9255 are provided. 	<p>[Specification]</p> <ul style="list-style-type: none"> • 1800 points of SM0 to SM1799 are provided. <p>[Measure]</p> <ul style="list-style-type: none"> • Although automatic conversion is executed for the QCPU replacement, review the points since some specifications differ between the two CPUs. 	△	Section 7.4
Special register	<ul style="list-style-type: none"> • 256 points of D9000 to D9255 are provided. 	<p>[Specification]</p> <ul style="list-style-type: none"> • 1800 points of SD0 to SD1799 are provided. <p>[Measure]</p> <ul style="list-style-type: none"> • Although automatic conversion is executed for the QCPU replacement, review the points since some specifications differ between the two CPUs. 	△	Section 7.5
Comment	<ul style="list-style-type: none"> • Comments are managed as a common comment or program original comment. • The comment capacity of AnSCPU is up to 127k (64k + 63k) bytes. 	<p>[Specification]</p> <ul style="list-style-type: none"> • For the QCPU, comments are managed as common comments or comments by program. (For the Basic model QCPU, only comments by program (MAIN) are managed.) • Comments are automatically replaced upon the QCPU conversion. • The comment capacity of the QCPU depends on memory capacity. 	○	Section 7.1.2
Writing programs to ROM	<ul style="list-style-type: none"> • The ROM operation is executed with the EP-ROM. 	<p>[Specification]</p> <ul style="list-style-type: none"> • The boot run is executed with programs stored in a standard ROM, memory card, or SD memory card upon the QCPU replacement. <p>[Measure]</p> <ul style="list-style-type: none"> • Execute the boot setting of PLC parameter. 	△	Section 7.7.12

(2) Comparison between QnASCPU and QCPU

○: Compatible, △:Partially changed, ×: Incompatible

Item	QnASCPU specifications	QCPU specifications and precautions for replacement	Compat-ibility	Reference
Sequence program SFC program	<ul style="list-style-type: none"> Each program is dealt as one file. 	[Specification] <ul style="list-style-type: none"> Each program is dealt as one file. 	○	–
Instruction	<ul style="list-style-type: none"> Dedicated instructions as display (LED) instruction, status latch (SLT) instruction, etc. are available. 	[Specification] <ul style="list-style-type: none"> With "Change PLC type", instructions are converted automatically except some instructions. [Measure] <ul style="list-style-type: none"> The instructions that cannot be converted are changed to SM1255 and SD1255 for QCPU, and SM999 and SD999 for the Basic model QCPU. Therefore, program modification is required. 	△	Section 7.2
File register	<ul style="list-style-type: none"> Data is stored in a memory card. One block is set in 32k points unit. 	[Specification] <ul style="list-style-type: none"> Data is stored in a standard RAM or memory card. One block is set in 32k points unit. [Measure] <ul style="list-style-type: none"> Review the setting. 	△	Section 7.7.11
Parameter	<ul style="list-style-type: none"> Dedicated parameters for each CPU are provided. 	[Specification] <ul style="list-style-type: none"> Dedicated parameters for each CPU are provided. [Measure] <ul style="list-style-type: none"> Check and re-set the parameters since specifications and functions differ between the two CPUs. 	△	Section 7.3
Special relay	<ul style="list-style-type: none"> 1800 points of SM0 to SM1799 are provided. 	[Specification] <ul style="list-style-type: none"> 1800 points of SM0 to SM1799 are provided. [Measure] <ul style="list-style-type: none"> Review the points since some specifications differ between the two CPUs. 	△	Section 7.4
Special register	<ul style="list-style-type: none"> 1800 points of SD0 to SD1799 are provided. 	[Specification] <ul style="list-style-type: none"> 1800 points of SD0 to SD1799 are provided. [Measure] <ul style="list-style-type: none"> Review the points since some specifications differ between the two CPUs. 	△	Section 7.5
Comment	<ul style="list-style-type: none"> Comments are managed as a common comment or program original comment. 	[Specification] <ul style="list-style-type: none"> For the QCPU, comments are managed as common comments or comments by program. (For the Basic model QCPU, only comments by program (MAIN) are managed.) 	○	Section 7.1.2

Item	QnASCPU specifications	QCPU specifications and precautions for replacement	Compat- ibility	Reference
Writing programs to ROM	<ul style="list-style-type: none"> • The boot run is executed with program and parameter stored in a memory card. • One memory card can be installed. 	<p>[Specification]</p> <ul style="list-style-type: none"> • The boot run is executed with the programs stored in a standard ROM, memory card, or SD memory card upon QCPU replacement. • One memory card or SD memory card can be installed. <p>[Measure]</p> <ul style="list-style-type: none"> • Execute the boot setting of PLC parameter. 	△	Section 7.7.12

7.1 Program Replacement Procedure

To replace programs and comments created by the AnS/QnAS series with the ones for the Q series, make the setting in the Change PLC type screen of GX Developer.

7.1.1 Program conversion procedure from AnS/QnASCPU to QCPU

Program conversion procedure follows the order of (1) → (2) → (3) below.

- (1) Reading process of conversion source data.
 - (a) Reading process of conversion source data.
 - (b) Program conversion from AnS/QnASCPU to QCPU with "Change PLC type".
- (2) Program conversion from AnS/QnASCPU to QCPU with "Change PLC type".
- (3) Writing process of converted data.
 - (a) Writing process of converted data.
 - (b) Storing project data of QCPU (Refer to (3)-(a) and (3)-(b) in the following diagram.)

Refer to Section 7.1.2 for details of the change operation.

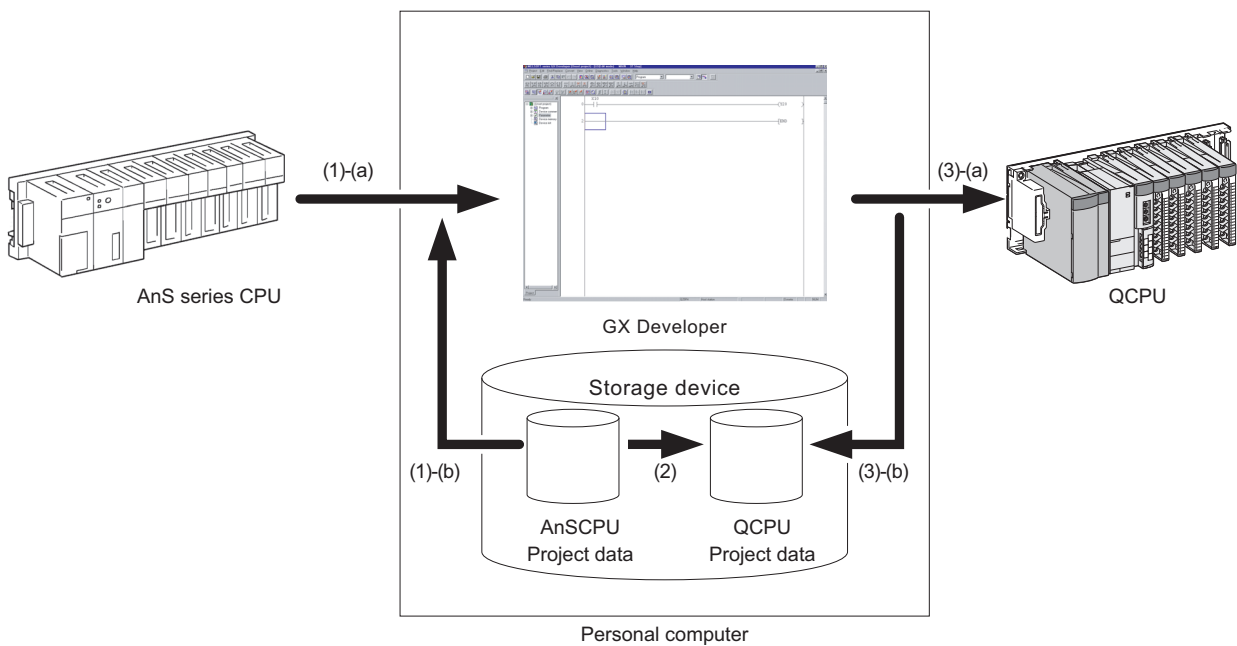
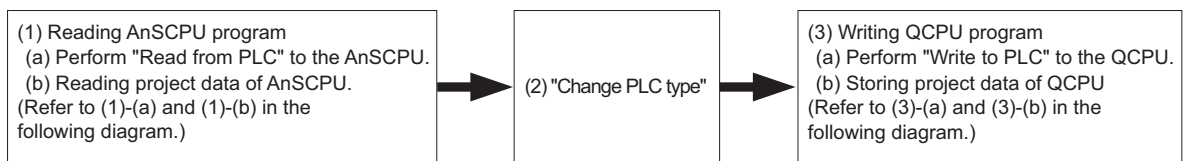

Remarks

Changing of "PLC type" from the existing CPU module to the High-speed Universal model QCPU is not supported in GX Developer.

When the existing CPU module is replaced with the High-speed Universal model QCPU, perform the following procedures.

- 1) Change "PLC type" from the existing CPU module to the High-speed Universal model QCPU and save the project in GX Developer.
- 2) Output the Q program for difference information implant and revised information list by using the A/QnA-Q conversion support tool.
- 3) Revise the Q program in GX Developer by referring the list.
- 4) Open the revised Q program (Project - Open Other Data - Open Other Project) and change "PLC type" from the existing CPU module to the High-speed Universal model QCPU in GX Works2.

7.1.2 Changing programmable controller type

"Change PLC type" is a function that changes the target programmable controller type of the data read to the GX Developer.

Some instructions that cannot be automatically converted are changed to "OUT SM1255" for QCPU ("OUT SM999" for the Basic model QCPU).

Search for these instructions or SM1255/SM999 in the converted program and modify the program manually.

For intelligent function modules and network modules, review programs and parameters.

(1) Applicable range of conversion from AnS/QnASCPU by the GX Developer

The following table shows the applicable range of conversion from the AnS/QnASCPU to other CPU. As it shows, converting to all CPUs is applicable.

Product	Change source	Change destination		
		ACPU, AnSCPU	QnACPU, QnASCPU	QCPU*1
GX Developer	AnSCPU, QnASCPU	○	○	○

*1 Changing of "PLC type" from the existing CPU module to the High-speed Universal model QCPU is not supported in GX Developer.

(2) Operation of GX Developer

(a) Select "Change PLC type" of the "Project" menu.

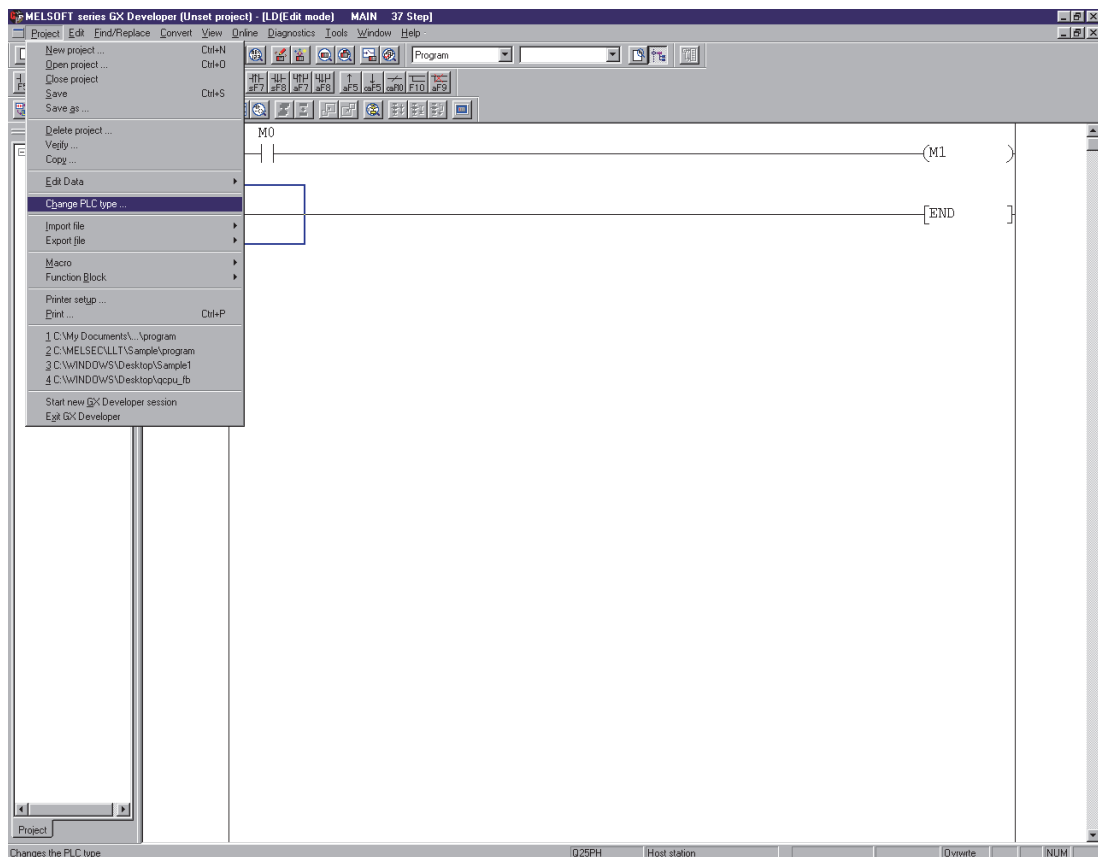

(b) Specify the target programmable controller type in the "Change PLC type" dialog box.

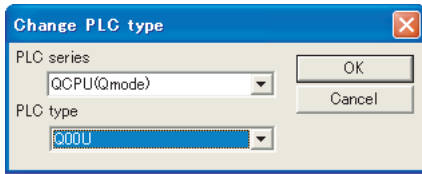

Click the [OK] button after setting the PLC type.

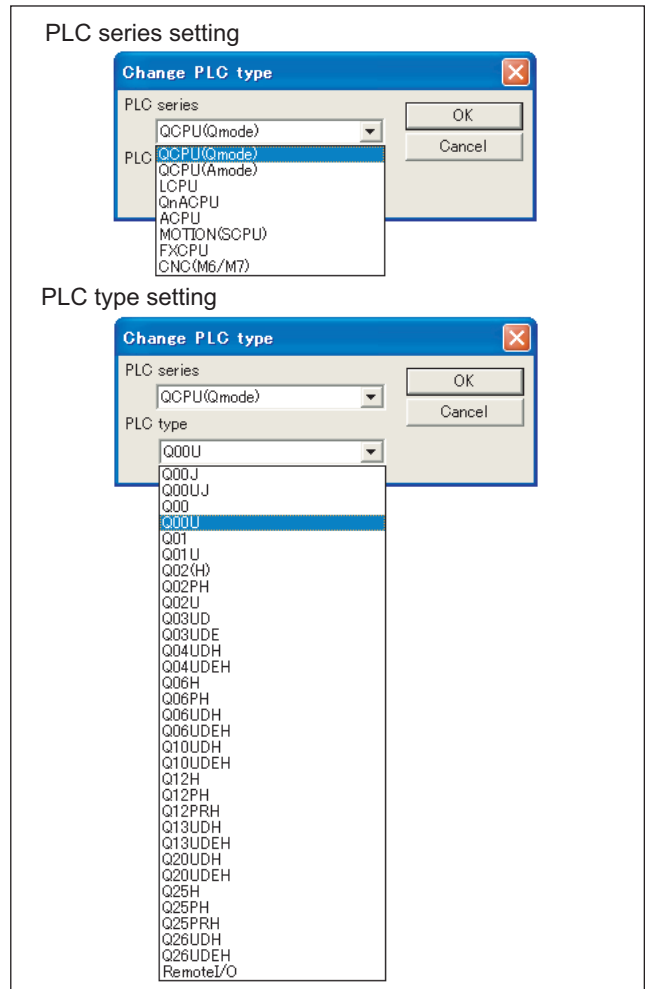

(c) Select the conversion method of special relays/registers.*1

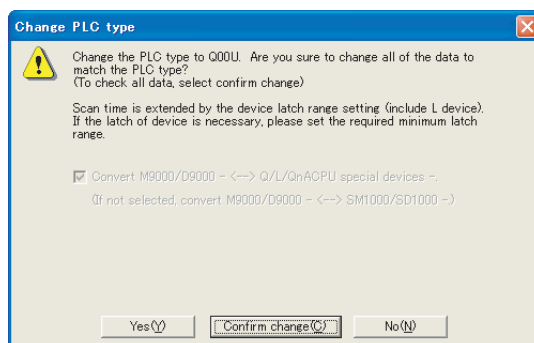

Specify the conversion destination of special relays/registers (AnS series CPU:M9000s/D9000s).

Check the [Convert M9000/D9000<=>Q/QnACPU special devices]

- Checked: Converted to the Q dedicated device.
- Not Checked: Converted to the A compatible (SM1000s/SD1000s).

Fixed to "Checked" when selecting the Basic model QCPU and the Universal model QCPU.

It is recommended to check the box when specifying the device conversion destination.

Click the [Yes] or [Confirm change] button after specifying the device conversion destination to start "Change PLC type".

- [Yes] : The change is executed without intermediate steps of user confirmation.
- [Confirm change]: Asks the user for confirming the changes.

*1 When changing from the QnAS series to the Q series, the conversion method of the special relay and special register cannot be selected.
(The Change PLC type screen above does not display the message to specify devices to be converted.)

☒ Point

Be aware of the following restrictions when changing the CPU module type to the Basic model QCPU by "Change PLC type".

If the change corresponds to either of the following, consider replacing the module with the High Performance model QCPU or the Universal model QCPU.

- 1) When changing the AnSCPU to the Basic model QCPU
 - Program file name
 - A ladder program is changed to "MAIN" program and a SFC program is changed to "MAIN-SFC" program.
 - Comment data
 - Only comments by program (MAIN) can be utilized.
 - Common comments are not replaced but lost.
- 2) When changing the QnASCPU to the Basic model QCPU
 - Program file name
 - Only "MAIN" ladder program and "MAIN-SFC" program can be utilized.
 - When other program names have been set to the programs, the programs are not replaced but lost. Change the names beforehand and then execute "Change PLC type".
 - Comment data
 - Only comments by program can be utilized.
 - Common comments are not replaced but lost.

7.1.3 AnSCPU program conversion ratio

- **Conversion ratio of common instructions (Sequence/basic/application instructions)**

The following table shows the conversion ratio when changing the programmable controller type of the AnSCPU common instructions to the QCPU.

More than 90% of the common instructions are automatically converted.

Instruction type	Number of instructions	Universal model QCPU			
		High Performance model QCPU		Conversion ratio (rough standard)	
		Number of instructions applicable for automatic conversion	Number of instructions requiring manual change		
Sequence instruction	Contact instruction	6	6	0	100%
	Connection instruction	5	5	0	100%
	Output instruction	6	5	1	83%
	Shift instruction	2	2	0	100%
	Master control instruction	2	2	0	100%
	Termination instruction	2	2	0	100%
	Other instructions	3	3	0	100%
Total number of sequence instructions		26	25	1	96%
Basic instruction	Comparison operation instruction	36	36	0	100%
	Arithmetic operation instruction	40	40	0	100%
	BCD ↔ BIN conversion instruction	8	8	0	100%
	Data transfer instruction	16	16	0	100%
	Program branch instruction	9	9	0	100%
	Program switching instruction	1	0	1	0%
	Link refresh instruction	2	2	0	100%
Total number of basic instructions		112	111	1	99%
Application instruction	Logical operation instruction	18	18	0	100%
	Rotation instruction	16	16	0	100%
	Shift instruction	12	12	0	100%
	Data processing instruction	20	19	1	95%
	FIFO instruction	4	4	0	100%
	Buffer memory access instruction	8	8	0	100%
	FOR to NEXT instruction	2	2	0	100%
	Local station, remote I/O station Access instruction	4	0	4	0%
	Display instruction	5	3	2	60%
	Other instructions	10	2	8	20%
Total number of application instructions		99	84	15	85%
Total number of sequence/basic/application instructions		237	220	17	93%

• **Conversion ratio of dedicated instructions**

The following table shows the conversion ratio when changing the programmable controller type of the AnSCPU dedicated instructions to the QCPU.

Instruction type	Number of instructions	Universal model QCPU		Conversion ratio (rough standard)	
		High Performance model QCPU			
		Number of instructions applicable for automatic conversion	Number of instructions requiring manual change		
Dedicated instruction (Functional extension)	Direct input/output instruction	3	3	0	100%
	Structured program instruction	6	2	4	33%
	Data operation instruction	6	6	0	100%
	I/O operation instruction	2	2	0	100%
	Real number processing instruction	27	27	0	100%
	Character string processing instruction	25	24	1	96%
	Data control instruction	6	6	0	100%
	Clock instruction	2	2	0	100%
	Extension file register instruction	7	0	7	0%
	Program switching instruction	4	0	4	0%
	Instruction for PID control	3	2	1	67%
Subtotal	91	74	17	81%	
Dedicated instruction (For modules)	Instruction for data link	9	5	4	56%
	Instruction for special function modules	59	0	59	0%
	Subtotal	68	5	63	7%
Total number of dedicated instructions		159	79	80	50%

Remarks

The automatic conversion is applied to the instructions of which equivalent functions and instructions exist in the change destination programmable controller.

Some instructions are not converted for the following causes.

Refer to Section 7.2 Instruction Conversion to change the program manually.

- (1) The change target programmable controller does not have the equivalent functions and instructions.
- (2) Instructions to specified modules cause to change the module and buffer memory configuration.
- (3) Multiple instructions with the same name and argument exist.
(Example) CHK instruction, etc.
- (4) The conversion causes a mismatch in the instructions.
(Example) IX instruction, etc.

7.1.4 Reading (Reusing) other format files

The following explains how to read (appropriate) files in the GPPQ/GPPA format other than that of the GX Developer. Follow this procedure to convert them to the file format of the GX Developer.

(1) Operation procedure

Select [Project] → [Import file] → [Import from GPPQ format file]
 [Import from GPPA format file]

(2) Setting screen

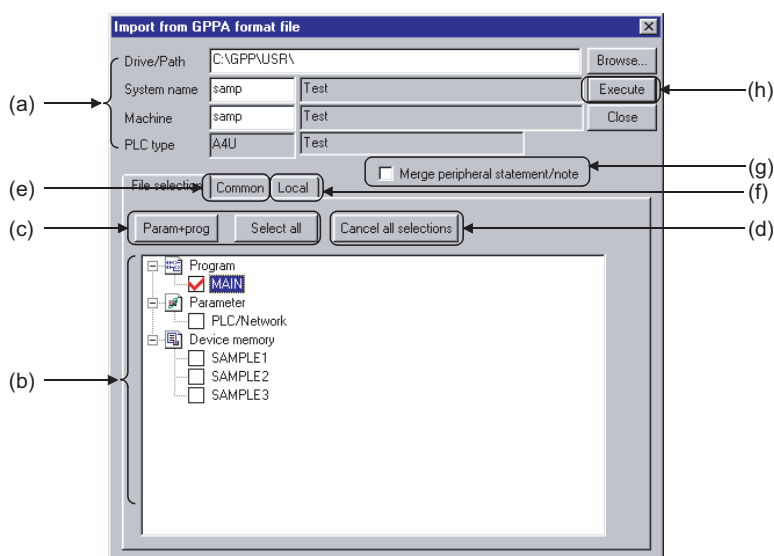

(a) Drive/Path, System name, Machine name, PLC type

Designates the location of data created in GPPQ or GPPA format.

Enter the system name and machine name of the data specified in the Drive/Path.

Clicking the [Browse] button shows the dialog box for choosing the system name and machine name.

Double-click the file to be read to specify.

(b) Source data list

Displays data created in GPPQ or GPPA format.

Check the checkbox of data names to be selected.

For the selected comments, the range of device comment, which can be read with the Common tab or Local tab, are settable.

(c) [Param+prog] button/[Select all] button

- [Param+prog] button

Selects only the parameter data and program data of the source data.

- [Select all] button

Selects all data in a source data list.

Comment 2 is selected for the AnS series, and the device memories of the number of data are displayed.

The first data name is selected for comments and file registers in the Q/QnAS series.

(d) [Cancel all selections] button

Cancels all the selected data.

(e) <<Common>> tab screen (AnS series)

Set this when specifying the range for common comments and read data.

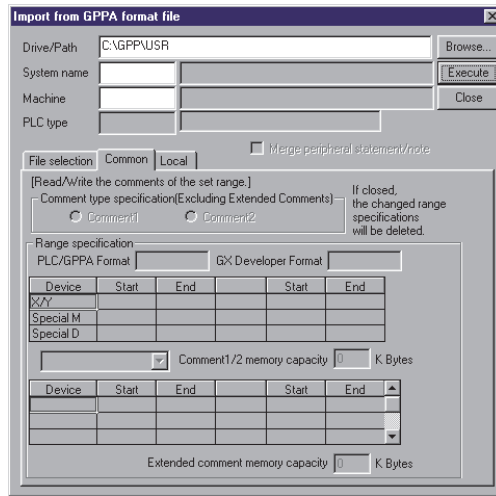

(f) <<Local>> tab screen (AnS series)

Set this when specifying the range for comments by program and read data.

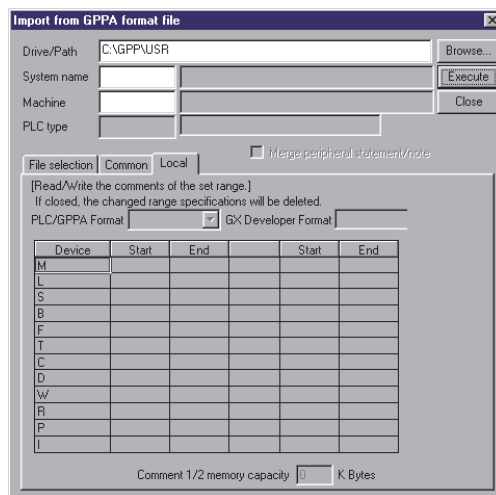

(g) Merge peripheral statement/note

For details of peripheral statements and merging notes, refer to the GX Developer Operating Manual.

(h) [Execute] button

Click this button after making the setting.

(3) Setting procedure

(a) Data selection

- 1) Set a drive/path for reading in GPPQ or GPPA format.
- 2) Click the [Browse] button to set the system name and machine name of the project to be read.
- 3) Check the checkbox of data to be selected by with the [Param+prog] button, [Select all] button, or the mouse.
- 4) Click the [Execute] button after making necessary settings.

(b) Canceling data selection

- 1) When canceling the selected data arbitrarily:
Clear the checkmark (P) in the checkbox with the mouse or space key.
- 2) When canceling all the selected data:
Click the [Cancel all selection] button.

(4) Precautions for reading the other format files

For AnS series	
A6GPP, SW0S-GPPA format data	Read data with GX Developer after performing the corresponding format conversion with GPPA. For the operating methods, refer to the Type SW4IVD-GPPA(GPP) Operating Manual.
For data selection	For device comment selection, you may only choose either comment 2 or comment 1.
GPPA format file reading	Deletes the project data on GX Developer and read the other format file. The area in excess of the program capacity is deleted when read. When the file includes microcomputer programs edited with other than the SFC program (e.g. SW0SRX-FNUP), they are lost.

For QnAS series	
Ladder return positions	Returning places are different between GPPQ and GX Developer. Because of this, if the total of return sources and return destinations exceeds 24 lines in a single ladder block, the program is not displayed properly. Corrective action: Add SM400 (normally on contact) to adjust the return positions.
For data selection	For the device memory and file register, you may select only one data name for each item.

7.2 Instruction Conversion

GX Developer enables instruction conversion using "Change PLC type".

The following explains how to process both applicable instructions and not applicable instructions for the conversion.

7.2.1 List of instructions conversion from AnSCPU to QCPU (Sequence/Basic/ Application instructions)

○: Automatic conversion △:Automatic conversion (only High Performance model QCPU) ×: Manual change required

Description	AnSCPU	Universal model QCPU, High Performance model QCPU		Reference
	Instruction name	Instruction name	Conversion	
BIN 16-bit addition, subtraction	+	+	○	
	+P	+P	○	
	-	-	○	
	-P	-P	○	
BIN 16-bit multiplication, division	*	*	○	
	*P	*P	○	
	/	/	○	
	/P	/P	○	
Ladder block series connection	ANB	ANB	○	
Series connection	AND	AND	○	
16-bit data comparison	AND<	AND<	○	
	AND<=	AND<=	○	
	AND<>	AND<>	○	
	AND=	AND=	○	
	AND>	AND>	○	
	AND>=	AND>=	○	
32-bit data comparison	ANDD<	ANDD<	○	
	ANDD<=	ANDD<=	○	
	ANDD<>	ANDD<>	○	
	ANDD=	ANDD=	○	
	ANDD>	ANDD>	○	
	ANDD>=	ANDD>=	○	
Series connection	ANI	ANI	○	
Conversion from hexadecimal BIN to ASCII	ASC	OUT SM1255	×	Section 7.2.3 (3)
BCD 4-digit addition, subtraction	B+	B+	○	
	B+P	B+P	○	
	B-	B-	○	
	B-P	B-P	○	
BCD 4-digit multiplication, division	B*	B*	○	
	B*P	B*P	○	
	B/	B/	○	
	B/P	B/P	○	
Conversion from BIN data to 4-digit BCD	BCD	BCD	○	
	BCDP	BCDP	○	
Conversion from 4-digit BCD to BIN data	BIN	BIN	○	
	BINP	BINP	○	
Block 16-bit data transfer	BMOV	BMOV	○	
	BMOVP	BMOVP	○	
Bit reset for word devices	BRST	BRST	○	
	BRSTP	BRSTP	○	
Bit set for word devices	BSET	BSET	○	
	BSETP	BSETP	○	
1-bit shift to left of n-bit data	BSFL	BSFL	○	
	BSFLP	BSFLP	○	

Description	AnSCPU	Universal model QCPU, High Performance model QCPU		Reference
	Instruction name	Instruction name	Conversion	
1-bit shift to right of n-bit data	BSFR	BSFR	○	
	BSFRP	BSFRP	○	
Sub-routine program calls	CALL	CALL	○	
	CALLP	CALLP	○	
Special format failure checks	CHK	OUT SM1255	×	Section 7.2.3 (3)
Bit device output reverse	CHK	OUT SM1255	×	Section 7.2.3 (1)
Main ↔ subprogram switching	CHG	OUT SM1255	×	Section 7.2.3 (2)
Pointer branch instruction	CJ	CJ	×	Section 7.7.8
Carry flag reset	CLC	OUT SM1255	×	Section 7.2.3 (3)
16-bit data negation transfer	CML	CML	○	
	CMLP	CMLP	○	
Link Refresh Instructions	COM	COM	○	
BIN 32-bit addition, subtraction	D+	D+	○	
	D+P	D+P	○	
	D-	D-	○	
	D-P	D-P	○	
BIN 32-bit multiplication, division	D*	D*	○	
	D*P	D*P	○	
	D/	D/	○	
	D/P	D/P	○	
Logical products of 32-bit data	DAND	DAND	○	
	DANDP	DANDP	○	
BCD 8-digit addition, subtraction	DB+	DB+	○	
	DB+P	DB+P	○	
	DB-	DB-	○	
	DB-P	DB-P	○	
BCD 8-digit multiplication, division	DB*	DB*	○	
	DB*P	DB*P	○	
	DB/	DB/	○	
	DB/P	DB/P	○	
Conversion from BIN data to 8-digit BCD	DBCD	DBCD	○	
	DBCDP	DBCDP	○	
Conversion from 8-digit BCD to BIN data	DBIN	DBIN	○	
	DBINP	DBINP	○	
32-bit data negation transfer	DCML	DCML	○	
	DCMLP	DCMLP	○	
32-bit BIN data decrement	DDEC	DDEC	○	
	DDECP	DDECP	○	
16-bit BIN data decrement	DEC	DEC	○	
	DECP	DECP	○	
8 → 256-bit decode	DECO	DECO	○	
	DECOP	DECOP	○	
2-word data read from the intelligent/special function module	DFRO	DFRO ^{*1}	○	
	DFROP	DFROP ^{*1}	○	
Interrupt disable instruction	DI	DI	○	
Refresh disable	DI	DI	○	
32-bit BIN data increment	DINC	DINC	○	
	DINCP	DINCP	○	
4-bit groupings of 16-bit data	DIS	DIS	○	
	DISP	DISP	○	
32-bit data transfer	DMOV	DMOV	○	
	DMOVP	DMOVP	○	
Logical sums of 32-bit data	DOR	DOR	○	
	DORP	DORP	○	
Left rotation of 32-bit data	DRCL	DRCL	○	Section 7.7.8
	DRCLP	DRCLP	○	Section 7.7.8

Description	AnSCPU	Universal model QCPU, High Performance model QCPU		Reference
	Instruction name	Instruction name	Conversion	
Right rotation of 32-bit data	DRCR	DRCR	○	Section 7.7.8
	DRCRP	DRCRP	○	Section 7.7.8
Left rotation of 32-bit data	DROR	DROR	○	Section 7.7.8
	DRORP	DRORP	○	Section 7.7.8
Right rotation of 32-bit data	DROR	DROR	○	Section 7.7.8
	DRORP	DRORP	○	Section 7.7.8
1-word shift to left of n-word data	DSFL	DSFL	○	
	DSFLP	DSFLP	○	
1-word shift to right of n-word data	DSFR	DSFR	○	
	DSFRP	DSFRP	○	
32 bit data checks	DSUM	DSUM	○	Section 7.7.8
	DSUMP	DSUMP	○	Section 7.7.8
2-word data write to the intelligent/special function module	DTO	DTO ^{*1}	○	
	DTOP	DTOP ^{*1}	○	
Timing pulse generation	DUTY	DUTY	○	
32-bit data conversion	DXCH	DXCH	○	
	DXCHP	DXCHP	○	
32-bit data non-exclusive logical sum operations	DXNR	DXNR	○	
	DXNRP	DXNRP	○	
32-bit exclusive logical sum operations	DXOR	DXOR	○	
	DXORP	DXORP	○	
Interrupt enable instruction	EI	EI	○	
Link refresh enable	EI	EI	○	
256 → 8-bit encode	ENCO	ENCO	○	
	ENCOP	ENCOP	○	
Sequence program termination	END	END	○	
Main routine program termination	FEND	FEND	○	
Reading oldest data from tables	FIFR	FIFR	○	
	FIFRP	FIFRP	○	
Writing data to the data table	FIFW	FIFW	○	
	FIFWP	FIFWP	○	
Identical 16-bit data block transfers	FMOV	FMOV	○	
	FMOV _P	FMOV _P	○	
FOR to NEXT instruction	FOR	FOR	○	
1-word data read from the intelligent/special function module	FROM	FROM	○ ^{*1}	
	FROM _P	FROM _P	○ ^{*1}	
16-bit BIN data increment	INC	INC	○	
	INCP	INCP	○	
Return from interrupt programs	IRET	IRET	○	
Pointer branch instruction	JMP	JMP	○	
Operation start	LD	LD	○	
BIN 16-bit data comparison	LD<	LD<	○	
	LD<=	LD<=	○	
	LD<>	LD<>	○	
	LD=	LD=	○	
	LD>	LD>	○	
	LD>=	LD>=	○	
BIN 32-bit data comparison	LDD<	LDD<	○	
	LDD<=	LDD<=	○	
	LDD<>	LDD<>	○	
	LDD=	LDD=	○	
	LDD>	LDD>	○	
	LDD>=	LDD>=	○	
Operation start	LDI	LDI	○	
ASCII code display instruction	LED	OUT SM1255	×	Section 7.2.3 (3)

*1 Note that the buffer memory address between Q series and AnS series may differ.

Description	AnSCPU	Universal model QCPU, High Performance model QCPU		Reference
	Instruction name	Instruction name	Conversion	
Character display instruction	LEDA	OUT SM1255	×	Section 7.2.3 (3)
	LEDB	OUT SM1255	×	Section 7.2.3 (3)
Comment display instruction	LEDC	OUT SM1255	×	Section 7.2.3 (3)
Annunciator reset instruction	LEDR	LEDR	○	
Local station data read	LRDP	OUT SM1255	×	Section 7.2.3 (3)
Local station data write	LWTP	OUT SM1255	×	Section 7.2.3 (3)
Master control set, reset	MC	MC	○	
	MCR	MCR	○	
16-bit data transfer	MOV	MOV	○	
	MOVP	MOVP	○	
Operation result pop	MPP	MPP	○	
Operation result push	MPS	MPS	○	
Operation result read	MRD	MRD	○	
BIN 16-bit data 2's complement	NEG	NEG	○	
	NEGP	NEGP	○	
FOR to NEXT instruction	NEXT	NEXT	○	
No operation (NOP, NOPLF)	NOP	NOP	○	
	NOPLF	NOPLF	○	
Parallel connection	OR	OR	○	
BIN 16-bit data comparison	OR<	OR<	○	
	OR<=	OR<=	○	
	OR<>	OR<>	○	
	OR=	OR=	○	
	OR>	OR>	○	
	OR>=	OR>=	○	
Ladder block parallel connection	ORB	ORB	○	
BIN 32-bit data comparison	ORD<	ORD<	○	
	ORD<=	ORD<=	○	
	ORD<>	ORD<>	○	
	ORD=	ORD=	○	
	ORD>	ORD>	○	
	ORD>=	ORD>=	○	
Parallel connection	ORI	ORI	○	
OUT instruction	OUT* ¹	OUT* ¹	○	
Trailing edge output	PLF	PLF	○	
Leading edge output	PLS	PLS	○	
Print ASCII code instruction	PR	PR	△	
Print comment instruction	PRC	PRC	△	
Left rotation of 16-bit data	RCL	RCL	○	Section 7.7.8
	RCLP	RCLP	○	Section 7.7.8
Right rotation of 16-bit data	RCR	RCR	○	Section 7.7.8
	RCRP	RCRP	○	Section 7.7.8
Return from subroutine program	RET	RET	○	
Remote I/O station data read	RFRP	OUT SM1255	×	Section 7.2.3 (3)
Read from automatic updating buffer memory	RIFR	OUT SM1255	×	Section 7.2.3 (11)
Read from intelligent device station buffer memory (with handshake)	RIRCV	OUT SM1255	×	Section 7.2.3 (11)
Read from intelligent device station buffer memory	RIRD	OUT SM1255	×	Section 7.2.3 (11)
Write to intelligent device station buffer memory (with handshake)	RISEND	OUT SM1255	×	Section 7.2.3 (11)
Write to automatic updating buffer memory	RITO	OUT SM1255	×	Section 7.2.3 (11)
Write to intelligent device station buffer memory	RIWT	OUT SM1255	×	Section 7.2.3 (11)
Network parameter setting	RLPA	OUT SM1255	×	Section 7.2.3 (11)
Automatic refresh parameter setting	RRPA	OUT SM1255	×	Section 7.2.3 (11)

*1 The high-speed timer or retentive timer can also be converted according to the parameter setting.

○: Automatic conversion △: Automatic conversion (only High Performance model QCPU) ×: Manual change required

Description	AnSCPU	Universal model QCPU		Reference
	Instruction name	High Performance model QCPU Instruction name	Conversion	
Left rotation of 16-bit data	ROL	ROL	○	Section 7.7.8
	ROLP	ROLP	○	Section 7.7.8
Right rotation of 16-bit data	ROR	ROR	○	Section 7.7.8
	RORP	RORP	○	Section 7.7.8
Bit device reset	RST	RST	○	
Remote I/O station data write	RTOP	OUT SM1255	×	Section 7.2.3 (3)
Pointer branch instruction	SCJ	SCJ	○	
7 segment decode	SEG	SEG	○	
Partial refresh	SEG	SEG	×	Section 7.7.8
16-bit data search	SER	SER	○	Section 7.7.8
	SERP	SERP	○	Section 7.7.8
Bit device set	SET	SET	○	
16-bit data n-bit left shift	SFL	SFL	○	
	SFLP	SFLP	○	
16-bit data n-bit right shift	SFR	SFR	○	
	SFRP	SFRP	○	
Bit device shift	SFT	SFT	○	
	SFTP	SFTP	○	
Setting and resetting status latch	SLT	OUT SM1255	×	Section 7.2.3 (3)
	SLTR	OUT SM1255	×	Section 7.2.3 (3)
Carry flag set	STC	OUT SM1255	×	Section 7.2.3 (3)
Sequence program stop	STOP	STOP	○	
Setting and resetting sampling trace	STRA	OUT SM1255	×	Section 7.2.3 (3)
	STRAR	OUT SM1255	×	Section 7.2.3 (3)
16-bit data checks	SUM	SUM	○	
	SUMP	SUMP	○	
Microcomputer program	SUB	OUT SM1255	×	
	SUBP	OUT SM1255	×	
1-word data write to the intelligent/ special function module	TO	TO	○*1	
	TOP	TOP	○*1	
4-bit linking of 16-bit data	UNI	UNI	○	
	UNIP	UNIP	○	
Logical products with 16-bit data	WAND	WAND	○	
	WANDP	WANDP	○	
WDT reset	WDT	WDT	○	
	WDTP	WDTP	○	
Logical sums of 16-bit data	WOR	WOR	○	
	WORP	WORP	○	
16-bit data non-exclusive logical sum operations	WXNR	WXNR	○	
	WXNRP	WXNRP	○	
16-bit exclusive logical sum operations	WXOR	WXOR	○	
	WXORP	WXORP	○	
16-bit data conversion	XCH	XCH	○	
	XCHP	XCHP	○	

*1 Note that the buffer memory address between Q series and AnS series may differ.

7.2.2 List of instruction conversion from AnSCPU to QCPU (Dedicated instructions)

○: Automatic conversion △:Automatic conversion (only High Performance model QCPU) ×: Manual change required

Description	AnSCPU	Universal model QCPU, High Performance model QCPU		Reference
	Instruction name	Instruction name	Conversion	
COS ⁻¹ operation on floating point data	ACOS	ACOS	○	
Floating point data addition	ADD	E+	○	
Conversion from hexadecimal BIN to ASCII	ASC	ASC	○	
SIN ⁻¹ operation on floating point data	ASIN	ASIN	○	
TAN ⁻¹ operation on floating point data	ATAN	ATAN	○	
BCD type COS ⁻¹ operation	BACOS	BACOS	○	
BIN 16-bit dead band controls	BAND	BAND	○	
BCD type SIN ⁻¹ operations	BASIN	BASIN	○	
BCD type TAN ⁻¹ operations	BATAN	BATAN	○	
Conversion from 4-digit BCD to decimal ASCII	BCDDA	BCDDA	○	
BCD type COS operations	BCOS	BCOS	○	
BCD 8-digit square roots	BDSQR	BDSQR	○	
Conversion from BIN 16-bit to decimal ASCII	BINDA	BINDA	○	
Conversion from BIN 16-bit to hexadecimal ASCII	BINHA	BINHA	○	
Block move between extension file registers	BMOVR	OUT SM1255	×	Section 7.2.3 (4)
Forced end of FOR to NEXT instruction loop	BREAK	BREAK	○	
BCD type SIN operations	BSIN	BSIN	○	
BCD 4-digit square roots	BSQR	BSQR	○	
BCD type TAN operations	BTAN	BTAN	○	
Data linking in byte units	BTOW	BTOW	○	
Block exchange between extension file registers	BXCHR	OUT SM1255	×	Section 7.2.3 (4)
Consecutive display of the same character	CC1	OUT SM1255	×	Section 7.2.3 (11)
	CC2	OUT SM1255	×	Section 7.2.3 (11)
Changing the character color	CCDSP	OUT SM1255	×	Section 7.2.3 (11)
	CCDSPV	OUT SM1255	×	Section 7.2.3 (11)
Special format failure checks	CHK	OUT SM1255	○	Section 7.2.3 (3), (4)
Changing check format of CHK instruction	CHKEND	OUT SM1255	○	Section 7.2.3 (4)
Displaying numerals	CIN0 to CIN9	OUT SM1255	×	Section 7.2.3 (11)
Displaying letters of the alphabet	CINA to CINZ	OUT SM1255	×	Section 7.2.3 (11)
Clearing display of designated area	CINCLR	OUT SM1255	×	Section 7.2.3 (11)
Displaying "-" (hyphen)	CINHP	OUT SM1255	×	Section 7.2.3 (11)
Displaying "-" (minus)	CINMP	OUT SM1255	×	
Displaying "." (period, decimal point)	CINPT	OUT SM1255	×	
Displaying spaces	CINSP	OUT SM1255	×	Section 7.2.3 (11)
Clearing the display area	CLS	OUT SM1255	×	Section 7.2.3 (11)
Clearing the VRAM area	CLV	OUT SM1255	×	Section 7.2.3 (11)
Setting the display mode	CMODE	OUT SM1255	×	Section 7.2.3 (11)
Transferring canvas data to the VRAM area	CMOV	OUT SM1255	×	Section 7.2.3 (11)
Setting normal display for characters	CNOR	OUT SM1255	×	Section 7.2.3 (11)
Displaying the cursor	COFF	OUT SM1255	×	Section 7.2.3 (11)
Designating the character display color	COLOR	OUT SM1255	×	Section 7.2.3 (11)
Reading device comment data	COMRD	COMRD	○	
Displaying the cursor	CON1	OUT SM1255	×	Section 7.2.3 (11)
	CON2	OUT SM1255	×	Section 7.2.3 (11)
COS operations on floating decimal point data	COS	COS	○	
Displaying a canvas screen	CPS1	OUT SM1255	×	Section 7.2.3 (11)
Changing the VRAM display address	CPS2	OUT SM1255	×	Section 7.2.3 (11)
Consecutive display of the same character	CR1	OUT SM1255	×	Section 7.2.3 (11)
	CR2	OUT SM1255	×	Section 7.2.3 (11)

Description	AnSCPU	Universal model QCPU, High Performance model QCPU		Reference
	Instruction name	Instruction name	Conversion	
Switching between normal and highlighted display for characters	CRDSP	OUT SM1255	×	Section 7.2.3 (11)
	CRDSPV	OUT SM1255	×	Section 7.2.3 (11)
Setting highlighted display for characters	CREV	OUT SM1255	×	Section 7.2.3 (11)
Scrolling the screen	CSCRD	OUT SM1255	×	Section 7.2.3 (11)
	CSCRU	OUT SM1255	×	Section 7.2.3 (11)
Conversion from decimal ASCII to BCD 4-digit data	DABCD	DABCD	○	
Conversion from decimal ASCII to BIN 16-bit data	DABIN	DABIN	○	
Reading clock data	DATERD	DATERD	○	
Writing in clock data	DATEWR	DATEWR	○	
BIN 32-bit dead band controls	DBAND	DBAND	○	
Conversion from BCD 8-digit to decimal ASCII data	DBCDDA	DBCDDA	○	
Conversion from BIN 32-bit to decimal ASCII data	DBINDA	DBINDA	○	
Conversion from BIN 32-bit data to hexadecimal ASCII data	DBINHA	DBINHA	○	
Conversion from decimal ASCII to BCD 8-digit data	DDABCD	DDABCD	○	
Conversion from decimal ASCII to BIN 32-bit data	DDABIN	DDABIN	○	
Conversion from floating point radian to angle	DEG	DEG	○	
Conversion from BIN 32-bit to floating point data	DFLOAT	DFLT	○	
Conversion from hexadecimal ASCII to BIN 32-bit data	DHABIN	DHABIN	○	
Conversion from floating point to BIN 32-bit data	DINT	DINT	○	
Dissociation of random data	DIS	NDIS	○	
Division of floating decimal point data	DIV	E/	○	
Upper and lower limit controls for BIN 32-bit data	DLIMIT	DLIMIT	○	
Direct output	DOUT	OUT	○	
Direct Reset	DRST	RST	○	
32-bit data searches	DSER	DSER	○	
Direct Set	DSET	SET	○	
Conversion from BIN 32-bit to character string	DSTR	DSTR	○	
Bit tests	DTEST	DTEST	○	
Conversion from character string to BIN 32-bit data	DVAL	DVAL	○	
Zone control for BIN 32-bit data	DZONE	DZONE	○	
Displaying characters	EPR	OUT SM1255	×	Section 7.2.3 (11)
	EPRN	OUT SM1255	×	Section 7.2.3 (11)
Writing characters to the VRAM	EPRV	OUT SM1255	×	Section 7.2.3 (11)
	EPRNV	OUT SM1255	×	Section 7.2.3 (11)
Exponent operations on floating decimal point data	EXP	EXP	○	
Sub-routine program output off calls	FCALL	FCALL	○	
Bit device output reverse	FF	FF	○	
Conversion from BIN 16 data to floating decimal point	FLOAT	FLT	○	
Reading VRAM data	GET	OUT SM1255	×	Section 7.2.3 (8), (9), (11)
Conversion from hexadecimal ASCII to BIN 16-bit	HABIN	HABIN	○	
Conversion from ASCII to hexadecimal BIN	HEX	HEX	○	
ASCII code conversion of designated character strings	INPUT	OUT SM1255	×	Section 7.2.3 (11)
Receiving data	INPUT2	OUT SM1255	×	Section 7.2.3 (9)
	INPUT4	OUT SM1255	×	Section 7.2.3 (9)
Conversion from floating decimal point data to BIN 16	INT	INT	○	
Index qualification of a circuit block	IX	OUT SM1255	×	Section 7.2.3 (4)
	IXEND	OUT SM1255	×	Section 7.2.3 (4)
Entering data from number keys	KEY	KEY	△	
Detecting character-string length	LEN	LEN	○	
Upper and lower limit controls for BIN 16-bit data	LIMIT	LIMIT	○	
Setting the cursor position	LOCATE	OUT SM1255	×	Section 7.2.3 (11)
Natural logarithm operations on floating decimal point data	LOG	LOG	○	
Reading word devices in local station	LRDP	OUT SM1255	×	Section 7.2.3 (4)

Description	AnSCPU	Universal model QCPU, High Performance model QCPU		Reference
	Instruction name	Instruction name	Conversion	
Writing data to word devices in local station	LWTP	OUT SM1255	×	Section 7.2.3 (4)
Communication with remote terminal modules	MINI	OUT SM1255	×	Section 7.2.3 (10)
Error resetting with remote terminal modules	MINIERR	OUT SM1255	×	Section 7.2.3 (10)
Multiplication of floating decimal point data	MUL	E*	○	
Monitoring PID Control Status	PID57	OUT SM1255	×	Section 7.2.3 (4)
PID control	PIDCONT	PIDCONT	○	
PID control data setting	PIDINIT	PIDINIT	○	
Displaying ASCII characters	PR	OUT SM1255	×	Section 7.2.3 (7), (8), (10), (11)
Sending data up to 00 _H code	PR2	OUT SM1255	×	Section 7.2.3 (9)
	PR4	OUT SM1255	×	Section 7.2.3 (9)
Displaying ASCII characters	PRN	OUT SM1255	×	Section 7.2.3 (7), (8), (10), (11)
Sending designated number of bytes of data	PRN2	OUT SM1255	×	Section 7.2.3 (9)
	PRN4	OUT SM1255	×	Section 7.2.3 (9)
Writing ASCII characters to the VRAM	PRV	OUT SM1255	×	Section 7.2.3 (11)
	PRNV	OUT SM1255	×	Section 7.2.3 (11)
Writing VRAM data	PUT	OUT SM1255	×	Section 7.2.3 (8), (9), (11)
Reading present value	PVRD1	OUT SM1255	×	Section 7.2.3 (6)
	PVRD2	OUT SM1255	×	Section 7.2.3 (6)
Setting preset data	PVWR1	OUT SM1255	×	Section 7.2.3 (6)
	PVWR2	OUT SM1255	×	Section 7.2.3 (6)
Conversion from floating decimal point angle to radian	RAD	RAD	○	
Remote I/O station data read	RFRP	OUT SM1255	×	Section 7.2.3 (4)
Changing the extension file register block number	RSET	OUT SM1255	×	Section 7.2.3 (4)
Remote I/O station data write	RTOP	OUT SM1255	×	Section 7.2.3 (4)
Block addition and subtraction	SADD	\$+	○	
Comparison between character strings	SCMP	OUT SM1255	×	Section 7.2.3 (4)
SIN operation on floating decimal point data	SIN	SIN	○	
Character string transfers	SMOV	\$MOV	○	
Reading communication status	SPBUSY	OUT SM1255	×	Section 7.2.3 (7), (9), (10)
Forced stop of communication processing	SPCLR	OUT SM1255	×	Section 7.2.3 (7), (9), (10)
Square root operations for floating decimal point data	SQR	SQR	○	
Reading the display status	STAT	OUT SM1255	×	Section 7.2.3 (11)
Conversion from BIN 16-bit to character string	STR	STR	○	
Subtraction of floating decimal point data	SUB	E-	○	
Setting comparison reference data	SVWR1	OUT SM1255	×	Section 7.2.3 (6)
	SVWR2	OUT SM1255	×	Section 7.2.3 (6)
Upper and lower byte exchanges	SWAP	SWAP	○	
TAN operation on floating decimal point data	TAN	TAN	○	
Bit test	TEST	TEST	○	
Linking of random data	UNI	NUNI	○	
Conversion from character string to BIN 16-bit data	VAL	VAL	○	
Data dissociation in byte units	WTOB	WTOB	○	
Link refresh of designated network	ZCOM	S.ZCOM	○	Section 7.2.3 (5)
Reading/writing data from/to special function module in MELSECNET/10 remote I/O station	ZNFR	OUT SM1255	×	Section 7.2.3 (5)
	ZNTO	OUT SM1255	×	Section 7.2.3 (5)
Reading from/writing to word devices in the MELSECNET/10 station	ZNRD	J.ZNRD	○	Section 7.2.3 (5)
	ZNWR	J.ZNWR	○	Section 7.2.3 (5)
Zone control for BIN 16-bit data	ZONE	ZONE	○	
Direct read/write of extension file registers in 1-word units	ZRRD	OUT SM1255	×	Section 7.2.3 (4)
	ZRWR	OUT SM1255	×	Section 7.2.3 (4)
Direct read/write of extension file registers in units of bytes	ZRRDB	OUT SM1255	×	Section 7.2.3 (4)
	ZRWRB	OUT SM1255	×	Section 7.2.3 (4)

7.2.3 Instructions that may need a replacement at instruction conversion from AnSCPU to QCPU

Some instructions are not automatically converted upon the replacement of the AnS series CPU with Q series CPU.

The following table shows the instructions that are not automatically converted. Reviewing the program is recommended.

Item No.	Instruction type	AnSCPU instruction	Corrective action	
(1)	Sequence instruction	Bit device output reverse	CHK (Counter Measure) Review the program and change manually. (Supplement) Change candidate instruction: [FF] instruction	
(2)	Basic instruction	Program switching instruction	CHG (Counter Measure) Review the program with referring to Section 7.7.10.	
		Microcomputer program call instruction	SUB SUBP (Counter Measure) Change manually to the same instructions of the Q series.	
(3)	Application instruction	ASCII characters convert instruction	ASC (Counter Measure) Review the program and change manually. (Supplement) Change candidate instruction: [\$MOV] instruction	
		MELSECNET (II), /B Local, Remote I/O station access instruction	LRDP	(Counter Measure) Reprogram for the network modules to use with a QCPU.
			LWTP	
			RFRP	
			RTOP	
		Display instructions (except dedicated instruction)	LED	(Counter Measure) Setting an external display is recommended since the QCPU does not have the LED display function.
			LEDA	
			LEDB	
			LEDC	
		Special format failure checks instruction	CHK (Counter Measure) Review the program and change manually. (Supplement) Change candidate instruction: [CHKST], [CHK] instruction	
Status latch instruction	SLT	(Counter Measure)		
	SLTR	There is no alternative action.		
Sampling trace instruction	STRA	(Counter Measure)		
	STRAR	Review the program and change manually. (Supplement) Change candidate instructions: [STRA] → [TRACE] instruction [STRAR] → [TRACER] instruction		
Carry flag instruction	STC	(Counter Measure)		
	CLC	Review the program and change manually. (Supplement) Change candidate instructions: [STC] → [SET SM700] instruction [CLC] → [RST SM700] instruction		
Print ASCII code instruction	PR (Counter Measures)			
Print comment instruction	PRC High Performance model QCPU can be used. For details to Universal model QCPU, refer to technical news (No.FA-A-0068).			

Item No.	Instruction type	AnSCPU instruction	Corrective action	
(4)	Dedicated instruction	Structured programs instruction	CHK	(Counter Measure) Change manually with the special format failure check instruction [CHK] of the application instructions.
			CHKEND	(Supplement) Change candidate instructions: [CHK] → [CHKCIR] instruction [CHKEND] → [CHKEND] instruction
			IX	(Counter Measure) Review the program and change manually.
		MELSEC (II), /B Local, Remote I/O station access instruction	IXEND	(Supplement) Change candidate instruction: [IX] → [IX] instruction [IXEND] → [IXEND] instruction
			LRDP	(Counter Measure) Reprogram the network modules to use with the QCPU.
			LWTP	
	RFRP			
	Character string data comparisons instruction	RTOP		
		SCMP	(Counter Measure) Review the program and change manually. (Supplement) Change candidate instructions: [LD\$=], [AND\$=], [OR\$=] instruction	
	Numerical key input from keyboard	KEY	(Counter Measure) Setting an external display that can input the figure is recommended.	
Extension file register instruction	BMOVR	(Counter Measure) Review the program and change manually. (Supplement) Change candidate instructions: [BMOV], [MOV], [RSET] instruction		
	BXCHR			
	RSET			
	ZRRD			
	ZRRDB			
	ZRWR			
PID control instruction	ZRWRB			
	PID57	(Counter Measure) There is no alternative action.		
(5)	Network dedicated instruction	Network instruction	ZCOM	(Counter Measure) Review the program and change manually. (Supplement) Change candidate instructions: [S (P). ZCOM Jn] or [S (P). ZCOM Un] instruction
			ZNRD	(Counter Measure) Reprogram the network modules to use with the QCPU.
		ZNWR		
		ZNFR		
		ZNTO		

Item No.	Instruction type	AnSCPU instruction	Corrective action
(6)	Control instruction for high-speed counter module type AD61(S1)	PVWR1	(Counter Measure) Reprogram for the network modules to use with the QCPU.
		PVWR2	
		SVWR1	
		SVWR2	
		PVRD1	
(7)	Control instruction for computer link module type AJ71C24 (S3,S6,S8)/AJ71UC24	PVRD2	
		PRN	
		PR	
		INPUT	
		SPBUSY	
(8)	Control instruction for memory card/centronics interface module type AD59	SPCLR	
		PRN	
		PR	
		GET	
		PUT	
(9)	Control instruction for terminal interface module type AJ71C21 (S1)	Special function modules instruction	(Counter Measure) Reprogram for the network modules to use with the QCPU. Restructuring the system is required depending on the module to be used.
		PRN2	
		PRN4	
		PR2	
		PR4	
		INPUT2	
		INPUT4	
		GET	
		PUT	
		SPBUSY	
SPCLR			
(10)	Control instruction for MELSECNET/MINI-S3 master module type AJ71PT32-S3	INPUT	
		PRN	
		PR	
		MINI	
		MINIERR	
		SPBUSY	
		SPCLR	

Item No.	Instruction type	AnSCPU instruction	Corrective action
(11)	Special function modules instruction	Control instruction for AD57 (S1)CRT controller module/ AD58 LCD controller module	
		CMODE	
		CPS1	
		CPS2	
		CMOV	
		CLS	
		CLV	
		CSCRU	
		CSCRD	
		CON1	
		CON2	
		COFF	
		LOCATE	
		CNOR	
		CREV	
		CRDSP	
		CRDSPV	
		COLOR	
		CCDSP	
		CCDSPV	(Counter Measure)
		PRN	Reprogram for the network modules to use with the QCPU.
		PR	Restructuring the system is required depending on the module to be used.
		PRNV	
		PRV	
		EPRN	
		EPR	
		EPRNV	
		EPRV	
		CR1	
		CR2	
		CC1	
		CC2	
		CINMT	
		CIN□ (□:0 to 9,A to Z)	
CINSP			
CINCLR			
INPUT			
GET			
PUT			
STAT			
CC-Link instruction	RIFR		
	RIRCV		
	RIRD	(Counter Measure)	
	RISEND	Change manually to the same instructions of the Q series.	
	RITO		
	RIWT		
	RLPA	(Counter Measure)	
RRPA	Set parameters with the GX Developer.		

7.2.4 Instruction conversion from QnASCPU to QCPU

The automatic conversion is applied to the instructions of which equivalent functions and instructions exist in the change target QCPU.

For instructions that are not automatically converted, consider reviewing the program referring to the inconvertible instructions described in Section 7.2.5.

Re-program for the modules to use with the QCPU, since the specifications of the intelligent function module instructions differ between QCPU compatible modules and QnASCPU compatible modules.

Remarks

When the indirect specification is used, execute the ADRSET instruction.
.....

7.2.5 Instructions that may need a replacement after conversion from QnASCPU to QCPU

Some instructions are not automatically converted upon the replacement of the QnASCPU with the QCPU.

The following table shows the instructions that are not automatically converted and their measures. Reviewing the program is recommended.

Instruction type		QnASCPU instruction	Corrective action
Sequence instruction	Index modification of entire ladder	IX	(Counter Measure) Review the program and change manually.
		IXEND	(Supplement) Change candidate instruction: [IX] → [ZPUSH] Replace the IX instruction with the ZPUSH instruction and set the contents of index modification table to index register. [IXEND] → [ZP.]
	Modification value specification in index modification of entire ladder	IXDEV	(Counter Measure)
		IXSET	Change the program so that the device offset values specified the IXSET instruction are directly set to the index modification table using the MOV instruction.
	Print ASCII code instruction	PR	(Counter Measures)
	Print comment instruction	PRC	High Performance model QCPU can be used. For details to Universal model QCPU, refer to the technical news (No.FA-A-0068).
	Special format failure checks instruction	CHKST	(Counter Measure)
		CHK	Review the program and change manually.
	Format change instruction for CHK instruction	CHKCIR	For details, please refer to the technical news (No.FA-A-0068).
		CHKEND	
Program low-speed execution registration instruction	PLOW	(Counter Measure) • Use the PSCAN instruction instead of this instruction when low-speed execution type programs are replaced with scan execution type programs. • No instruction can be used if low-speed execution type programs are replaced with fixed scan execution type programs.	
Program execution status check instruction	PCHK	(Counter Measure) Check a program execution status on the Program monitor list screen of GX Developer. For details, refer to the QCPU User's Manual (Function Explanation, Program Fundamentals).	
Application instruction	Display instruction	LED	(Counter Measure)
		LEDC	Setting an external display is recommended since the QCPU does not have the LED display function.
	Status latch instruction	SLT	(Counter Measure)
		SLTR	There is no alternative action.
	Sampling trace instruction	STRA	(Counter Measure)
		STRAR	Review the program and change manually. (Supplement) Change candidate instructions: [STRA] → [TRACE] instruction [STRAR] → [TRACER] instruction
	Program trace instruction	PTRA	(Counter Measure)
		PTRAR	There is no alternative action.
		PTRAEXE	
	Other instructions	EROMWR	(Counter Measure) Review the program and change manually. (Use the ATA card as a memory card.) (Supplement) Change candidate instruction: [EROMWR] → [FWRITE] instruction
PID control instruction	PID57	(Counter Measure) There is no alternative action.	
Special function modules instruction Example: G. INPUT, G. PRN, etc.	G (P). [Instruction name]	(Counter Measure) Reprogram for the special function modules to use with the QCPU.	

7.3 Precautions for Replacement of Parameter

7.3.1 Conversion from AnSCPU to QCPU

This section explains the parameter conversion upon replacement of the AnSCPU programs with the QCPU.

<Compatibility>

○: Common item between AnSCPU and QCPU, that can be converted directly.

△: Item that requires re-setting after the conversion, since the functions/specifications are partially different

×: Item to be deleted, since there is no common item between the AnSCPU and QCPU.

Confirm the parameters after the conversion, and correct/re-set as required.

Name		Compat- ibility	Remarks	
Memory capacity	Sequence program capacity	△	No need to care about the program capacity.	
	Microcomputer program capacity	×	No microcomputer program is available.	
	Comment capacity	△	Not required, since comments can be created for all devices.	
	File register capacity	△	Resetting is required since the specifications are different.	
PLC RAS setting	WDT setting	△	This becomes default (200ms).	
	Operation mode when there is an error	△	This becomes default (All stop).	
	Annunciator display mode	×	No compatible function is available.	
PLC system setting	RUN - PAUSE contact	△	Re-setting is required.	
	Output mode at STOP to RUN	△	This becomes default (Output before STOP).	
	Data communications request batch processing	△	Please use COM instructions. For the Universal model QCPU, set the service processing setting in the PLC parameter. For the High Performance model QCPU, set the communication reserved time to the special register (SD315).	
	Interrupt counter setting	△	Re-setting is required.	
I/O assignment		△	Reviewing is required for the base unit with other than 8 slots.	
Device setting	Number of device points	○	This resets to default.	
	Latch range	Latch relay L	○	M and L are different devices. "L" on the program is converted to "L".
		Data register D	○	
		Link relay B	○	
		Link register W	○	
		Low-speed timer High-speed timer Extension low-speed timer Extension high-speed timer	△	Converted as one device. Reviewing is required, since all the range from lowest device No. to highest device No. is included in the latch range.
		Retentive timer Extension retentive timer	△	Converted as one device. Reviewing is required, since all range from lowest device No. to highest device No. is included in the latch range.
	Counter Extension counter	△	Converted as one device. Reviewing is required, since the latch range covers all range from lowest device No. to highest device No.	

	Name	Compat- ibility	Remarks
Network parameter	MELSECNET (II), /B	×	Parameters are deleted, since the Q series CPU is not compatible with the MELSECNET (II), /B.
	MELSECNET/10 (H)	○	For A2USCPU, converted to the MELSECNET/10 mode. Parameter re-setting is required for the AnS(H)CPU.
	MELSECNET/MINI	△	Parameters are deleted, since the QCPU is not compatible with the MELSECNET/MINI. (It is possible to correspond by new sequence program.) Moreover, the Universal model QCPU is not compatible.

7.3.2 Conversion from QnASCPU to QCPU

This section explains the parameter conversion upon replacement of the QnASCPU program with the QCPU.

The symbols in the table indicate the following meanings:

<Compatibility>

○: Common item between QnASCPU and QCPU, therefore can be converted directly

△: Item that requires re-setting after the conversion, since the functions/specifications are partially different

×: Item to be deleted, since there is no common item between the QnASCPU and QCPU

Confirm the parameters after the conversion, and correct/re-set as required.

Name		Compat- ibility	Remarks	
PLC name setting	Label	○		
	Comment	○		
PLC system setting	Timer limit setting	Low speed	○	
		High speed	○	
	RUN-PAUSE contact	RUN	○	
		PAUSE	○	
	Remote reset	○		
	Output mode at STOP to RUN	○		
	Common pointer No.	○		
	General data processing	△	Use COM instructions or set the communication reserved time for the special register (SD315) as required.	
	Number of empty slots	○		
	System interrupt setting	Interrupt counter setting No.	△	Re-setting is required.
		I28 Fixed scan interval	○	
		I29 Fixed scan interval	○	
		I30 Fixed scan interval	○	
I31 Fixed scan interval		○		
PLC file setting	File register	△	Confirmation is required, since the usable target memory is changed.	
	Comment file used in a command	△	Confirmation is required, since the usable target memory is changed.	
	Device initial value	△	Confirmation is required, since the usable target memory is changed.	
	File for local device	△	Confirmation is required, since the usable target memory is changed.	
Device setting	Input relay	○		
	Output relay	○		
	Internal relay	○		
	Latch relay	○		
	Link relay	○		
	Annunciator	○		
	Link special relay	○		
	Edge relay	○		
	Step relay	○		
	Timer	○		
	Retentive timer	○		
	Counter	○		
	Data register	○		
	Link register	○		
	Link special register	○		
Total of device	○			

		Name	Compat- ibility	Remarks	
PLC RAS setting	WDT setting	WDT setting	○		
		Initial execution monitoring time	○		
		Low speed execution monitoring time	○		
	Error check	Carry out battery check	○		
		Carry out fuse blown check	○		
		Carry out I/O module comparison	○		
	Operation mode when there is an error	Computation error	○		
		Expanded command error	○		
		Fuse blown	○		
		I/O module comparison error	○		
		Special module access error	○	The name changes to "Intelligent module program execution error".	
		Memory card access error	○		
	Annunciator display mode	Constant scanning	○		
		F No. display	×	The QCPU does not incorporate this display function.	
		Comment display	×	The QCPU does not incorporate this display function.	
		Occurrence time	×	The QCPU does not incorporate this display function.	
	Break down history	Drive	○	The storage location in the Universal model QCPU is fixed, therefore this setting does not exist.	
		File name	○		
		History No.	○		
			Low speed program execution time	○	There is no low speed program in Universal model QCPU.
			I/O assignment	△	Reviewing is required if the Q series CPU base unit has other than 8 slots.
		Boot file setting	○		
		Program setting	○		
SFC setting	SFC program start mode		○		
	Start conditions		○		
	Output mode when the block is stopped		○		
Network parameter	MELSECNET (II), /B		×	Parameters are deleted, since the Q series CPU is not compatible with the MELSECNET (II), /B.	
	MELSECNET/10 (H)		○	Converted to the MELSECNET/10 mode.	
	MELSECNET/MINI		×	The Universal model QCPU is not compatible.	
	CC-Link		○	The number of settable parameters with the software package is eight.*1 Set the parameters of the ninth module or later with dedicated instructions.	
	Ethernet		○	The "Use the KeepAlive" of "TCP Existence confirmation setting" in the "Ethernet operations" is automatically set.	

*1 For the number of mountable CC-Link modules and the number of settable parameters with the software package, refer to the CC-Link System Master/Local Module User's Manual.

7.4 Replacement of Special Relay

The special relay is an internal relay that has a set application in a programmable controller. This section explains how to replace special relay when replacing the AnSCPU programs for the QCPU. Some AnS/QnASCPU special relays not compatible with the QCPU, for details please refer to QCPU Users Manual (Function Explanation, Program Fundamentals)/Programming Manual (Common Instruction).

7.4.1 Replacing the AnSCPU with the QCPU

The QCPU uses a different special relay from the one for the AnSCPU. With "Change PLC type", the automatic conversion is applied to the replacement of the AnSCPU special relay (M9000 and after) with the QCPU special relay (SM). (Refer to Section 7.1.2)

Point

- (1) Some AnSCPU special relays are not compatible with the QCPU. Those special relays not compatible with the QCPU are converted to dummy special relays (SM1255)*¹ when changing programmable controller type. Search the dummy special relays (SM1255) and correct the programs as required.

*¹ For the Basic model QCPU, it is converted to the SM999.

7.4.2 Replacing the QnASCPU with the QCPU

Basically, special relays for the QnASCPU can be used without modification in the QCPU.*¹ Note that, however, some of them are not compatible with the QCPU.

*¹ When programs for the QnASCPU are replaced with those for the Universal model QCPU or the High Performance model QCPU by "Change PLC type", devices for the QnASCPU, SM1000 to SM1255 and SD1000 to SD1255, are replaced with those for the QCPU.

Note when programs for the QnASCPU are replaced with those for the Basic model QCPU by "Change PLC type", the devices for the QnASCPU may be replaced with SM999 and SD999 as an unsupported device.

7.5 Replacement of Special Register

A special register is an internal register that has a set application in a programmable controller. This section explains how to replace special register when replacing the AnSCPU programs for the QCPU.

Some AnS/QnASCPU special registers not compatible with the QCPU, for details please refer to QCPU Users Manual (Function Explanation, Program Fundamentals)/Programming Manual (Common Instruction).

7.5.1 Replacing the AnSCPU with the QCPU

The QCPU uses a different special register from the one for the AnSCPU.

With "Change PLC type", the automatic conversion is applied to the replacement of the AnSCPU special register (D9000 and after) with the QCPU special register (SD).

Point

- (1) Some AnSCPU special registers are not compatible with the QCPU. Those special registers not compatible with the QCPU are converted to dummy special registers (SD1255)^{*1} when changing programmable controller type. Search the dummy special registers (SD1255) and correct the programs as required.

^{*1} For the Basic model QCPUs, converted to the SD999.

7.5.2 Replacing the QnASCPU with the QCPU

Basically, special registers for the QnASCPU can be used without modification in the QCPU.^{*1} Note that, however, some of them are not compatible with the QCPU.

^{*1} When programs for the QnASCPU are replaced with those for the Universal model QCPU or the High Performance model QCPU by "Change PLC type", devices for the QnASCPU, SM1000 to SM1255 and SD1000 to SD1255, are replaced with those for the Q series CPU.

Note when programs for the QnASCPU are replaced with those for the Basic model QCPU by "Change PLC type", the devices for the QnASCPU may be replaced with SM999 and SD999 as an unsupported device.

7.6 Precautions for Replacement of the MELSAP-II with the MELSAP3

The basic operation of the MELSAP3 is the same as the MELSAP-II, but the specifications are partially different.

This section provides the precautions for the replacement.

7.6.1 Starting SFC program

The SFC program can be started by using the special relay for starting/stopping the SFC program. That special relay for the AnSCPU (M9101) is replaced with the special relay for the QCPU (SM321) upon converting from the AnSCPU to QCPU. The specifications of the special relay for starting or stopping SFC program partially differ between the AnSCPU and QCPU.

Specifications		Precautions for replacement
MELSAP-II (M9101)	MELSAP3 (SM321)	
Switches on and off with user operation.	SFC program starts up at default, since system is automatically turned on.	When starting/stopping the SFC program according to user conditions, turn the SM321 to on/off with program.

7.6.2 Block information (SFC information device)

The MELSAP-II and MELSAP3 have different method of executing the "Block START/STOP" and "Reading of the number of active steps and active step numbers" with block information (SFC information device).

	Specifications		Precautions for replacement
	MELSAP-II	MELSAP3	
Block START/STOP methods	<p>[START] Switching the block active bit on, executes forced start.</p> <p>[STOP] Switching the block clear bit on, stops the block also switching from on to off executes forced stop.</p>	<p>[START] Switching the block START/STOP bit on starts the concerned block forcibly.</p> <p>[STOP] Switching the block START/STOP bit off stops the concerned block forcibly.</p>	<p>[START] Adjusting program is not required when replacing the SFC program of the AnSCPU with the QCPU, since in that case, the "Block active bit" is replaced with the "Block START/STOP bit".</p> <p>[STOP] Add the program that resets the "Block START/STOP bit" to the "Block clear bit". Delete the program that switches the "Block clear bit "on/off.</p>
The number of active steps and active step numbers reading	Reads the number of active steps in the corresponding block and active step numbers.	Reads only the number of active steps in the corresponding block.	To read the active step numbers, use the "Active step batch readout instructions (MOV, DMOV, BMOV)".

7.6.3 Specifications comparison between MELSAP-II and MELSAP3

A part of the specifications of SFC program (MELSAP3) are different from those of SFC program (MELSAP-II). Therefore, when utilizing the SFC program (MELSAP-II) of A/AnSCPU as the SFC program (MELSAP3) of QCPU, select the QCPU that meets the specifications of the existing SFC program (MELSAP-II).

Contents	MELSAP-II	MELSAP3			
	A/AnSCPU	Universal model QCPU		Basic model QCPU	High Performance model QCPU
		Q00UJ, Q00U, Q01U, Q02U	Q03UD(E), Q03UDV, Q04UD(E)H, Q04UDV, Q06UD(E)H, Q06UDV	Q00J, Q00, Q01	Q02(H), Q06H
SFC block	Max.256	Max.128	Max.320	Max.128	Max.320
Number of SFC steps	Max.255 steps/block	Max.128 steps/block	Max.512 steps/block	Max.128 steps/block	Max.512 steps/block
Step transition monitoring timer	Equipped (8 timers)	None	None	None	Equipped (10 timers)

7.6.4 MELSAP3 specifications comparison between QnASCPU and QCPU

A part of the specifications of SFC program (MELSAP3) are different from those of SFC program (MELSAP3). Therefore, when utilizing the SFC program (MELSAP3) of QnASCPU as the SFC program (MELSAP3) of QCPU, select the QCPU that meets the specifications of the existing SFC program (MELSAP3).

Contents		MELSAP3				
		QnA/QnASCPU	Universal model QCPU		Basic model QCPU	High Performance model QCPU
			Q00UJ, Q00U, Q01U, Q02U	Q03UD(E), Q03UDV, Q04UD(E)H, Q04UDV, Q06UD(E)H, Q06UDV	Q00J, Q00, Q01	Q02(H), Q06H
SFC block		Max.320	Max.128	Max.320	Max.128	Max.320
Number of SFC steps		Max.512 steps/block	Max.128 steps/block	Max.512 steps/block	Max.128 steps/block	Max.512 steps/block
Step transition monitoring timer		Equipped (10 timers)	None	None	None	Equipped (10 timers)
SFC program start mode setting	Act at block multi-activated	Equipped	None (Wait only)	None (Wait only)	None (Wait only)	Equipped
	Act at step multi-activated	Equipped	None (Transfer only)	None (Transfer only)	None (Transfer only)	Equipped
	Periodic execution block setting	Equipped	None	None	None	Equipped
SFC control instructions	Forced transition check instruction					
	LD etc. TRn ^{*1}	Equipped	None	None	None	Equipped
	LD etc. BLm\TRn ^{*1}					
	Active step change instruction					
	SCHG (D)	Equipped	None	None	None	Equipped
	Transition control instruction					
	SET TRn	Equipped	None	None	None	Equipped
	SET BLm\TRn					
	RST TRn					
	RST BLm\TRn					
Block switching instruction						
BRSET (S)	Equipped	None	None	None	Equipped	
SFC program for program execution management		Equipped	None	None	None	Equipped
Program execution type setting		Equipped	None	None	None	Equipped

*1 LDI/AND/OR/LDI/ANI/ORI instructions correspond besides LD instruction.

7.6.5 SFC diagram that cannot be read normally in another format

SFC diagram created by SW□IVD/NX-GPPA may cause an error such as incorrect reading.

Add dummy steps before replacement with SW□IVD/NX-GPPA.

(Refer to "PRECAUTIONS FOR CREATING SFC PROGRAMS" in the GX Developer Version 8 Operating Manual (SFC).)

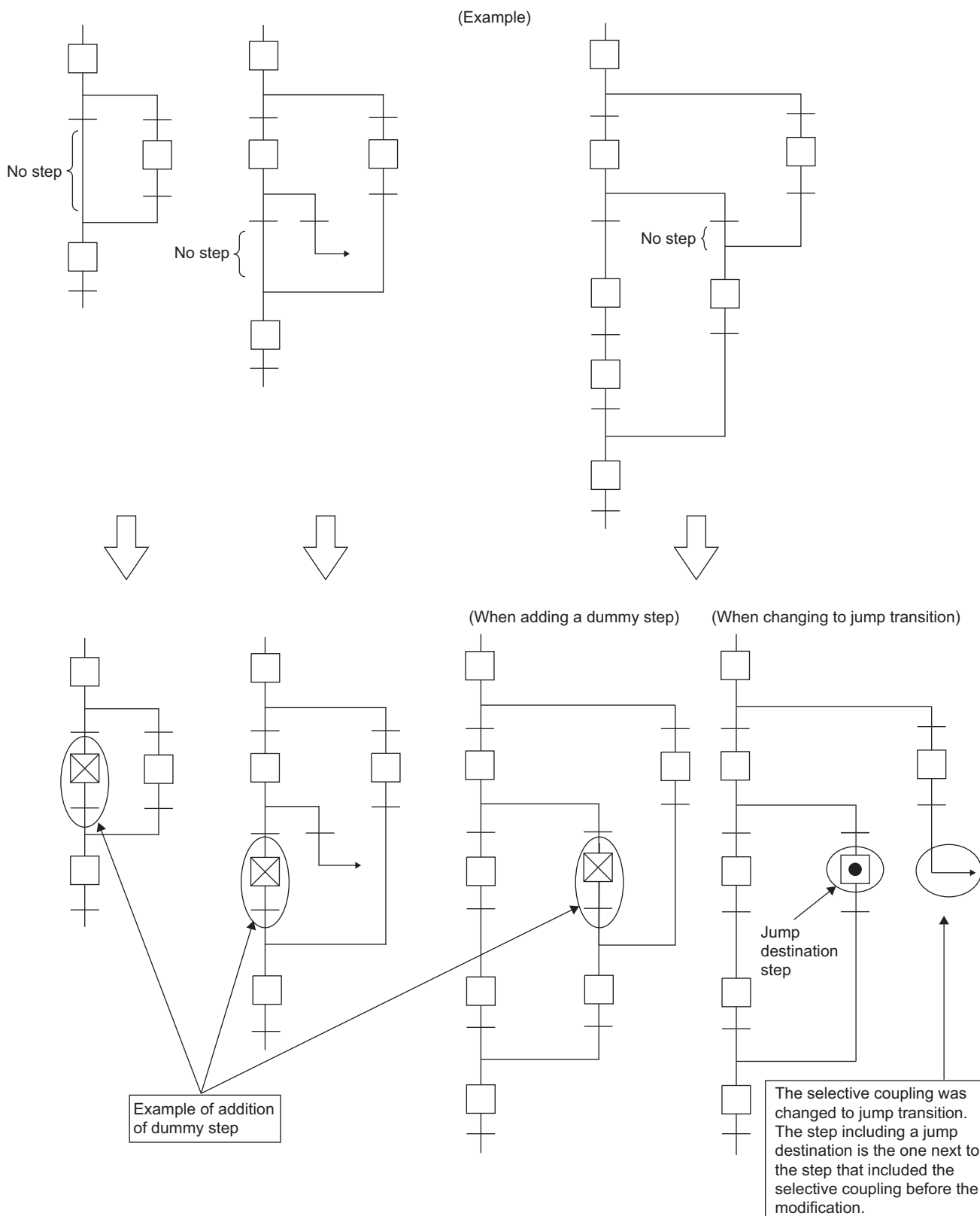

7.7 Precautions for Program Replacement

7.7.1 List of applicable devices

Device name		QCPU			
Number of I/O points ^{*9}		Q00J: 256 points Q00: 1024 points Q01: 1024 points	Q02, Q02H, Q06H, Q12H, Q25H, Q02PH, Q06PH, Q12PH, Q25PH, Q12PRH, Q25PRH } 4096 points	Q00UJ: 256 points Q00U: 1024 points Q01U: 1024 points Q02U, Q03UD(E), Q04UD(E)H, Q06UD(E)H } 4096 points ^{*10}	Q03UDV } Q04UDV } 4096 points Q06UDV } Q13UDV }
Number of I/O device points ^{*8}		2048 points	8192 points		
Internal relay		8192 points ^{*1}			Q03UDV: 9216 points Q04/06UDV: 15360 points
Latch relay		2048 points ^{*1}	8192 points ^{*1}		
Step relay	Sequence program	—			
	SFC	2048 points ^{*6}	8192 points		
Annunciator		1024 points ^{*1}	2048 points ^{*1}		
Edge relay		1024 points ^{*1}	2048 points ^{*1}		
Link relay		2048 points ^{*1}	8192 points ^{*1}		
Link special relay		1024 points	2048 points		
Timer		512 points ^{*1}	2048 points ^{*1}		
Retentive timer		0 point ^{*1}			
Counter		512 points ^{*1}	1024 points ^{*1}		
Data register		11136 points ^{*1}	12288 points ^{*1}	Q03UDV: 13312 points Q04/06UDV: 22528 points	
Link register		2048 points ^{*1}	8192 points ^{*1}		
Link special register		1024 points	2048 points		
Function input		16 points: (FX0 to FXF) ^{*7}			
Function output		16 points: (FY0 to FYF) ^{*7}			
Special relay		1024 points	2048 points		
Function registers		5 points: (FD0 to FD4)			
Special register		1024 points	2048 points		
Link direct device		For CC-Link IE, MELSECNET/H J□□\X□□, J□□\Y□□, J□□\W□□, J□□\B□□, J□□\SW□□, J□□\SB□□			
Intelligent function module device		Specified from U□□\G□□			
Index register	Z	10 points: (Z0 to Z9)	16 points: (Z0 to Z15)	20 points: (Z0 to Z19)	
	V ^{*2}	—			
File register		32768 points/block ^{*5} (R0 to R32767)	32768 points/block ^{*5 *11} (R0 to R32767)		
Extended data register ^{*1}		—	—	0 point	
Extended link register ^{*1}		—	—	0 point	
Accumulator ^{*3}		—			
Nesting		15 points			
Pointer		300 points	4096 points ^{*13}	4096 points	
Interrupt pointer		128 points	256 points ^{*14}	256 points	
SFC block device		128 points ^{*6}	320 points ^{*12}	320 points	
SFC transition device		—	512 points/block	—	
Decimal constant		K-2147483648 to K2147483647			
Hexadecimal constant		H0 to HFFFFFFF			
Real constant ^{*6}		E±1.17550-38 to E±3.40282+38			
Character string		"QCPU", "ABCD" ^{*4}			

	QnASCPU	AnSCPU	
	Q2AS: 512 points Q2AS-S1: 1024 points Q2ASH: 512 points Q2ASH-S1: 1024 points	A2US: 512 points A2US-S1: 1024 points A2USH-S1: 1024 points	A1SJH: 256 points A1SH: 256 points A2SH: 512 points
	8192 points		2048 points
	8192 points ^{*1}	Total 8192 points	Total 2048 points
	8192 points ^{*1}		
	-		
	8192 points	-	
	2048 points ^{*1}	2048 points	256 points
	2048 points ^{*1}	-	
	8192 points ^{*1}	8192 points	1024 points
	2048 points	56 points	
	2048 points ^{*1}	Total 2048 points	Total 256 points
	0 points ^{*1}		
	1024 points ^{*1}	1024 points	256 points
	12288 points ^{*1}	8192 points	1024 points
	8192 points ^{*1}	8192 points	1024 points
	2048 points	56 points	
	16 points (FX0 to FXF) ^{*7}	-	
	16 points (FY0 to FYF) ^{*7}	-	
	2048 points	256 points	
	5 points (FD0 to FD4)	-	
	2048 points	256 points	
	Specified from J□\□□	-	
	Specified from U□\G□	-	
	16 points (Z0 to Z15)	7 points (Z, Z1 to Z6)	1 point (Z)
	-	7 points (V, V1 to V6)	1 point (V)
	32768 points/block (R0 to R32767)	8192 points/block (R0 to R8191)	
	-	-	
	-	-	
	-	2 points	
	15 points	8 points	
	4096 points	256 points	
	48 points	32 points	
	320 points	-	
	512 points/block	-	
	K-2147483648 to K2147483647		
	H0 to HFFFFFFF		
	E±1.17550-38 to E±3.40282+38	-	
	"QnACPU", "ABCD" ^{*4}	-	

- *1 The number of points for use can be changed with parameters.
- *2 "V" is used for edge relays for the QCPU/QnASCPU.
- *3 The format of instructions that use the accumulator for the AnSCPU/AnUSCPU is changed for the QCPU/QnASCPU.
- *4 For the Q00JCPU and Q00CPU, and Q01CPU, they can be used with the \$MOV instruction.
- *5 The Q00JCPU, Q00UJCPU does not have file registers.
- *6 Applicable to the first 5 digits of serial number (Q00JCPU, Q00CPU and Q01CPU) of 04122 or higher.
- *7 Each 5 points of FX0 to FX4 and FY0 to FY4 can be used on the programs.
- *8 The number of points that can be used on the programs.
- *9 The number of accessible points to actual I/O modules.
- *10 The number of I/O points of the Q02UCPU is 2048 points.
- *11 For the Universal model QCPU, set the total number of points of file register, extended data register, and extended link register with parameters.
- *12 The number of device points of SFC block for the Q00UJCPU, Q00UCPU, Q01UCPU, Q02UCPU is 128 points.
- *13 The number of pointer for the Q00UJCPU, Q00UCPU, Q01UCPU is 512 points.
- *14 The number of Interrupt pointer for the Q00UJCPU, Q00UCPU, Q01UCPU is 128 points.

☒ Point

Some devices and constants are not shown in the "List of applicable devices".
For details, refer to the user's manual for the QCPU.

7.7.2 I/O control method

○ : Usable, – : Unusable

I/O control method		QCPU	QnASCPU	AnSCPU	
				AnUS(H)CPU	AnS(J)HCPU
Refresh mode		○	○	○	○ ^{*2}
Direct I/O method	Partial refresh instructions	○	○	○	○
	Dedicated instructions ^{*1}	–	–	○	–
	Direct access input	○	○	–	–
	Direct access output	○	○	–	–
Direct mode		–	–	–	○ ^{*2}

*1 The direct output dedicated instructions include the DOUT, DSET and SRST instruction and do not include the direct input dedicated instructions.

*2 The DIP switch on the CPU module enables to switch between refresh mode and direct mode.

7.7.3 Usable data format for instructions

○ : Usable, △ : Conditionally usable, – : Unusable

Setting data		QCPU	QnASCPU	AnSCPU	
				AnUS(H)CPU	AnS(J)HCPU
Bit data	Bit device	○		○	○
	Word device	○ (Bit designation required)		–	–
Word data	Bit device	○ (Digit designation required)		○ (Digit designation required)	○ (Digit designation required)
	Word device	○		○	○
Double-word data	Bit device	○ (Digit designation required)		○ (Digit designation required)	○ (Digit designation required)
	Word device	○		○	○
Real number data		○ ^{*2}		△ ^{*4}	△ ^{*1}
Character string data		○ ^{*3}		△ ^{*4}	△ ^{*1}

*1 The microcomputer package for the floating point real number type of the SW0SRXV-FUN2 package can be used during entry.

*2 Applicable to the first 5 digits of serial number (Q00J/Q00/Q01CPU) of 04122 or higher.

*3 For the Q00J/Q00/Q01CPU, it can be used with the \$MOV instruction.

*4 The AnA/AnU dedicated instruction can be used.

7.7.4 Timer

Function		QCPU/QnASCPU	AnSCPU	
			AnUS(H)CPU	AnS(J)HCPU
Low-speed timer	Measurement unit	<ul style="list-style-type: none"> • 100ms (Default) Changeable in the range of 1 to 1000ms (Parameter) (QnACPU: 10 to 1000ms) 	<ul style="list-style-type: none"> • Fixed to 100ms 	
	Specifying method			
High-speed timer	Measurement unit	<ul style="list-style-type: none"> • 10ms (Default) Changeable in the range of 0.1 to 100ms (parameter) (QnACPU: 1 to 100ms) 	<ul style="list-style-type: none"> • Fixed to 10ms 	
	Specifying method			
Retentive timer	Measurement unit	<ul style="list-style-type: none"> • The same measurement unit as low-speed timer 	<ul style="list-style-type: none"> • Fixed to 100ms 	
	Specifying method			
High-speed retentive timer	Measurement unit	<ul style="list-style-type: none"> • The same measurement unit as high-speed timer 	<ul style="list-style-type: none"> • None 	
	Specifying method			
Setting range for set value		• 1 to 32767	• 1 to 32767	
Processing the set value 0		• Instant-on	• Infinite (No time up)	
Updating present value		• When executing the OUT Tn instruction	• When executing the END processing	
On/off processing for contact				

(1) Precautions for using timer

The following shows precautions when using timers.

For details, refer to the QCPU User's Manual (Function Explanation, Program Fundamentals).

(a) Q/QnASCPU timer ladder programming method

Set the number of points for the timer and retentive timer in the Device setting of the parameter setting.

To use the low-speed timer, high-speed timer, retentive timer and high-speed retentive timer separately, add "H" or "S" to the OUT instruction in programming.

Ex.) Low-speed timer: OUT T0 Kn

High-speed timer: OUT HT0 Kn

Low-speed retentive timer: OUT ST0 Kn

High-speed retentive timer : OUT HST0 Kn

(b) AnSCPU timer ladder programming method

Set the total number of points of timer, and the first device number of low-speed timer, high-speed timer and retentive timer in the Device setting of the parameter setting.

The default setting is as follows:

Number of points of timer: 256

First device number of low-speed timer: 0 (T0 to T199)

First device number of high-speed timer: 200 (T200 to T255)

First device number of retentive timer: 0

When using the retentive timer, change the setting to reserve necessary number of points.

7.7.5 Counter

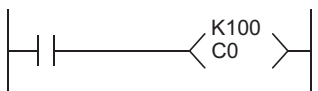
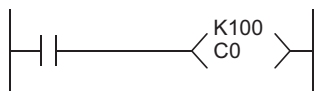
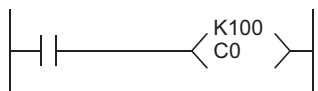
Function	QCPU/QnASCPU	AnSCPU	
		AnUS(H)CPU	AnS(J)HCPU
Specifying method			
Updating present value	• When executing the OUT Cn instruction	• When executing the END instruction	
On/off processing for contact			

7.7.6 Display instructions

Function	QCPU/QnASCPU	AnSCPU	
		AnUS(H)CPU	AnS(J)HCPU
PR ^{*1}	<ul style="list-style-type: none"> • With SM701 off: Outputs characters before 00_H. • With SM701 on: Outputs 16 characters. 	<ul style="list-style-type: none"> • With M9049 off: Outputs characters before 00_H. • With M9049 on: Outputs 16 characters. 	
PRC ^{*1}	<ul style="list-style-type: none"> • With SM701 off: Outputs comments in 32 characters. • With SM701 on: Outputs first 16 characters of comment. 	• Outputs comment in 16 characters.	

*1 Not applicable for the Universal model QCPU and the Basic model QCPU.

7.7.7 Index register

(1) Replacing index register

"Z, Z1 to Z6, V, V1 to V6" and "Z0 to Z15" are used as index register for the AnS series and Q series, respectively. Therefore, their specifications differ.

"V" is used as edge relay for the Q series. The device is used to memorize the PLS/PLF information to contacts from the start of the ladder block.

The following table shows replacement of index register when AnS series program was utilized to the Q series with "Change PLC type".

AnS series	Q series
Z	Z0
Z1 to Z6	Z1 to Z6
V	Z7
V1 to V6	Z8 to Z13

☒ Point

When modifying contact instructions of timer/counter with indexes, AnA/AnUCPU has no restrictions on index registers.

For QCPU, only "Z0, Z1" can be specified for index registers when modifying contact instructions of timer/counter with indexes according to its specifications.

When using index registers other than "Z0, Z1" in the existing AnA/AnUCPU, it is replaced with "SM1255" as unconvertible instruction. Therefore, correcting/changing program is required.

(2) Index register 32-bit specification

When using index register as 32-bit instruction in the AnS series, Z and V that has the same number with Z are processed as low-order 16-bit value and high-order 16-bit value, respectively.

However, the Q series processes Zn and Zn + 1 as low-order 16 bits and high-order 16 bits, respectively.

If a program to which "Change PLC type" is performed includes index register with 32-bit specification, reviewing the index register after "Change PLC type" is necessary.

The following shows an example using an instruction whose operation result will be in 32 bits.

Instruction	AnS series	Q series
DMOV D0 Z1	V1, Z1 (High order) (Low order)	Z2, Z1 (High order) (Low order)
/ D0 D1 Z1	Z1 (Quotient) V1 (Remainder)	Z1 (Quotient) Z2 (Remainder)

When utilizing the AnS series program to the Q series with "Change PLC type", the operation result may be stored to the index register having different number as intended one.

(Example)

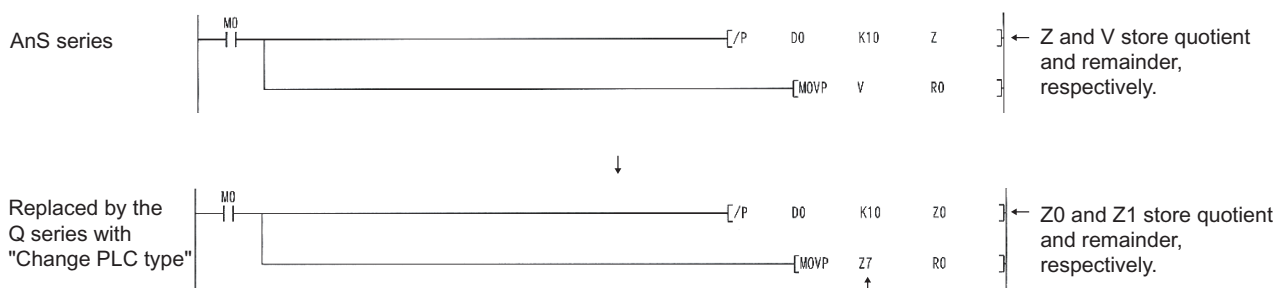

Device replaced with "Change PLC type".
Modify this to Z1.

7.7.8 Instructions where format is changed (Excluding AnUSCPU dedicated instructions)

Instructions using the accumulator for the AnSCPU are changed in their format, since the QCPU/ QnASCPU do not have the accumulator (A0, A1).

The accumulator A0 is converted to SD718, the accumulator A1 is converted to SD719.

Function	QCPU/QnASCPU		AnSCPU	
	Format of instruction	Remarks	Format of instruction	Remarks
Right rotation of 16-bit data	$\text{ROR } D \ n$	• D: Rotation data	$\text{ROR } n$	• Rotation data is set in A0.
	$\text{RCR } D \ n$	• D: Rotation data • Use SM700 for carry flag.	$\text{RCR } n$	• Rotation data is set in A0. • Use M9012 for carry flag.
Left rotation of 16-bit data	$\text{ROL } D \ n$	• D: Rotation data	$\text{ROL } n$	• Rotation data is set in A0.
	$\text{RCL } D \ n$	• D: Rotation data • Use SM700 for carry flag.	$\text{RCL } n$	• Rotation data is set in A0. • Use M9012 for carry flag.
Right rotation of 32-bit data	$\text{DROR } D \ n$	• D: Rotation data	$\text{DROR } n$	• Rotation data is set in A0, A1.
	$\text{DRCR } D \ n$	• D: Rotation data • Use SM700 for carry flag.	$\text{DRCR } n$	• Rotation data is set in A0, A1. • Use M9012 for carry flag.
Left rotation of 32-bit data	$\text{DROL } D \ n$	• D: Rotation data	$\text{DROL } n$	• Rotation data is set in A0, A1.
	$\text{DRCL } D \ n$	• D: Rotation data • Use SM700 for carry flag.	$\text{DRCL } n$	• Rotation data is set in A0, A1. • Use M9012 for carry flag.
16-bit data search	$\text{SER } S1 \ S2 \ D \ n$	• Search result is stored in D, D + 1 device.	$\text{SER } S1 \ S2 \ n$	• Search result is stored in A0, A1.
32-bit data search	$\text{DSER } S1 \ S2 \ D \ n$	• Search result is stored in D, D + 1 device.	$\text{DSER } S1 \ S2 \ n$	• Search result is stored in A0, A1.
16-bit data checks	$\text{SUM } S \ D$	• Check result is stored in D device.	$\text{SUM } S$	• Check result is stored in A0.
32-bit data checks	$\text{DSUM } S \ D$	• Check result is stored in D device.	$\text{DSUM } S$	• Check result is stored in A0.
Partial refresh	$\text{RFS } D \ n$	• Add dedicated instruction.	$\text{SEG } D \ n$	• Only when M9052 is on.*2
8-characters ASCII conversion	$\text{\$MOV } (\text{Charactor strings}) \ D$		$\text{ASC } (\text{Charactor strings}) \ D$	*3
Carry flag set	$\text{SET } \text{SM700}$	• No dedicated instruction	STC	*3
Carry flag reset	$\text{RST } \text{SM700}$	• No dedicated instruction	CLC	*3

Function	QCPU/QnASCPU		AnSCPU	
	Format of instruction	Remarks	Format of instruction	Remarks
Jump to END instruction		• Add dedicated instruction.		• P255: END instruction specification ^{*3}
CHK instruction ^{*1}		• Add CHKST instruction.		^{*3}

*1 Not applicable to the Universal model QCPU, the Basic model QCPU.

*2 Deleting or adjusting is required, since it becomes the instruction of different function.

*3 Converted to "SM1255" as inconvertible instruction.

7.7.9 AnUSCPU dedicated instruction

(1) Display method of dedicated instruction

The dedicated instructions for the AnUSCPU using LEDA, LEDB, LEDC, and LEDR instructions are changed into instructions in the same format as basic instructions and application instructions for the QCPU/QnASCPU.

Some instructions are not converted since the QCPU/QnASCPU does not have the corresponding instruction.

The instructions are converted into OUT SM1255 or OUT SM999 (Q00J/Q00/Q01CPU).

Replace or delete instructions that has been converted to the OUT SM1255/OUT SM999.

QCPU/QnASCPU	AnUSCPU
	S, D, n indicate the data used in instructions.

(2) Dedicated instruction with changed instruction name

For the AnUSCPU, some instruction names are the same as the basic instructions/application instructions. Those names have been changed for the QCPU/QnASCPU.

Function	QCPU/QnASCPU	AnUSCPU
Floating decimal point addition	E+	ADD
Floating decimal point subtraction	E-	SUB
Floating decimal point multiplication	E*	MUL
Floating decimal point division	E/	DIV
Data dissociation	NDIS	DIS
Data linking	NUNI	UNI
Check pattern updates	CHKCIR, CHKEND	CHK, CHKEND

7.7.10 Setting method when multiple sequence programs are created

For the AnSCPU, when a main program including SFC program is replaced for the QCPU, the programs are separated into different programs.

For the separated programs in the QCPU, the Program setting of the parameter setting is required. This section provides precautions after replacement of program settings, etc.

(1) Program files at replacement

(a) When main program contains SFC program

For the AnSCPU, the SFC program operates as the microcomputer program of main program. Since the QCPU deals the SFC program as one program, the SFC program is converted to "MAIN-SFC". Accordingly, two separate programs are created when the ACPU is converted; "MAIN", converted from main program, and "MAIN-SFC".

Register in the order of MAIN, MAIN-SFC in the Program setting of the parameter setting of GX Developer, and set all execution types to "Scan".

Refer to Section 7.6 for precautions of replacing from the AnSCPU SFC (MELSAP-II) to the QCPU (MELSAP3).

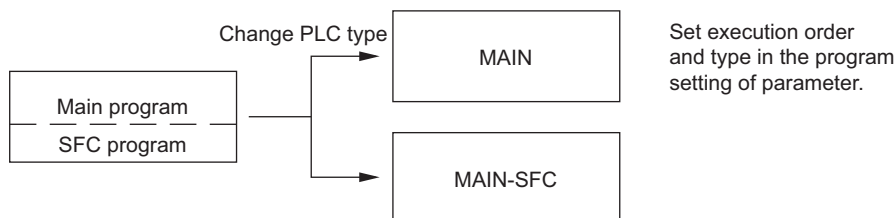

(2) Program setting of the GX Developer

The following explains required program settings for executing multiple programs.

The execution type of program is set in Program setting of the PLC parameter setting of GX Developer. CPU module executes the programs of the specified execution type in the setting order.

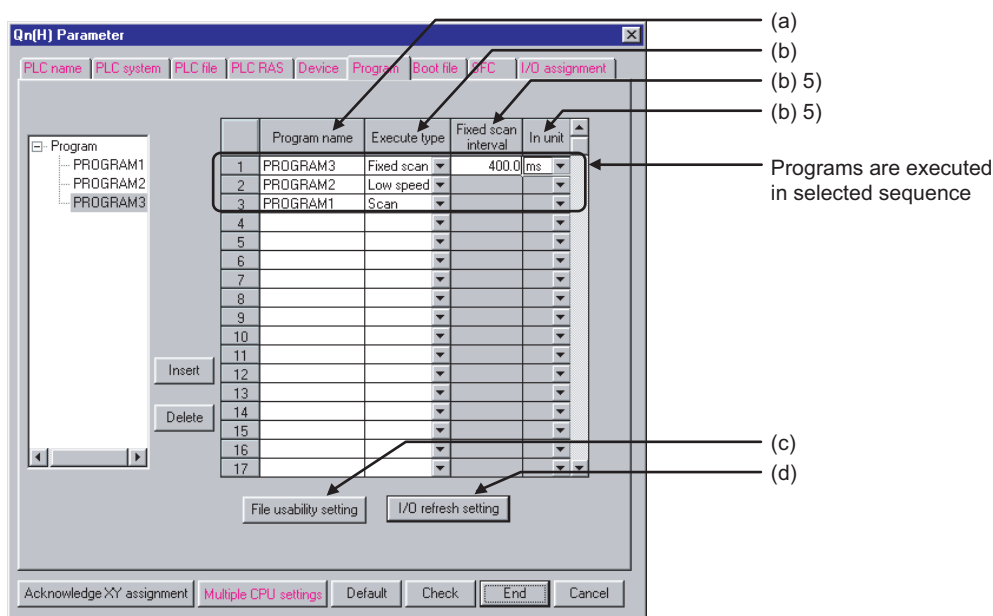

(a) Program name

Set a name for a program to be executed with a CPU module.

(b) Execution type

Select the execution type of files set in the program name.

1) Initial execution type (Initial)

This type of programs is executed only one time, when switching the power supply from off to on or STOP status to RUN status.

2) Scan execution type (Scan)

This type of programs is executed every scan, after having executed the initial execution type program.

3) Low speed execution type (Low speed)

This type of programs is executed only when the constant scan or low speed type program execution time is set.

4) Stand-by type (Wait)

This type of program is executed only when demanded.

5) Fixed scan execution type (Fixed scan)

This type of program is executed per interval set in the "Fixed scan interval" and "In unit".

- Fixed scan interval

Sets the program execution interval of fixed execution type program.

Setting range depends on the unit set in the fixed scan interval.

- For "ms": 0.5 to 999.5ms (0.5ms unit)

- For "s": 1 to 60s (1s unit)

- Unit

Selects the unit ("ms" or "s") for the fixed scan interval.

7.7.11 Precautions for file register replacement

This section provides precautions for replacing the AnSCPU or QnASCPU using file registers with the QCPU.

	AnSCPU	QnASCPU	QCPU
Storage destination	Memory cassette	Memory card (Up to 1 cards, 2 drives)	<ul style="list-style-type: none"> • Standard RAM • Memory card (1 card)^{*1}
Maximum number of points	Depends on applicable memory cassette used	1018k points (When using 2M memory cards)	Standard RAM: Up to 512k points ^{*2} (Depending on CPU model) + 4086k points (When using a 8M memory card)
Number of points for 1 block	8k points	32k points	32k points

*1 The High-speed Universal model QCPU cannot store the file register into an SD memory card.

*2 The High-speed Universal model QCPU can store up to 4608K points into the standard RAM when the extended SRAM cassette for 8M bytes is used.

(1) Changing storage destination after replacement

(a) Changing storage destination after replacement of the AnSCPU

The value whose capacity has been set with the parameter of AnSCPU is not converted, since the storage destination is different.

Set the storage destination and capacity (points) in the file setting of the PLC parameter setting.

Be sure to select "Use the following file" when setting the storage destination.

Selecting "Use the following file" makes the file equivalent to the AnSCPU.

(b) Changing storage destination after replacement of the QnASCPU

Drive No. for storing file registers differs between the QnASCPU and QCPU.

Set the parameters (Standard RAM, memory card (RAM)^{*3}, memory card (ROM)^{*3}) according to the drive where the file register is stored.

*3 The High-speed Universal model QCPU cannot be used the memory card (RAM) and memory card (ROM).

(2) Number of points for one block

1) Number of points for one block after replacement of the AnSCPU

For the AnSCPU with the extension file registers, the number of points for one block is 8k points.
For the QCPU, the number of points for one block is 32k points.

2) Number of points for one block after replacement of the QnASCPU

Definition of file register capacity is the same for the QnASCPU and QCPU.

When the storage destination and maximum number of points are the same, program adjustment for file registers is not required.

7.7.12 Boot run method (Writing programs to ROM)

The ROM operation of the AnSCPU corresponds to the boot run of the QCPU. The overview of the boot run is explained below.

Refer to QCPU User's Manual (Function Explanation, Program Fundamentals) for details.

(1) How to proceed the boot operation of the Universal model QCPU

The Universal model QCPU does not have to perform the boot operation since its program memory is a Flash ROM.

(The data written to files are not erased even if a battery error occurs.)

However, the Universal model QCPU other than Q00UJCPU, Q00UCPU, and Q01UCPU can perform the boot operation by using a memory card or an SD memory card.

For the procedure of the boot operation using a memory card, refer to the following:

Procedure 1: Configure the boot file settings.

Set the names of the files to be booted to the program memory in the Boot file tab of the PLC parameter dialog box of GX Developer^{*1}.

Procedure 2: Mount the memory card.

Mount the memory card or SD memory card to the CPU module.

Procedure 3: Write data to the memory card.

Write the parameters and programs set in the Boot file tab to the memory card or SD memory card using GX Developer^{*1}.

Procedure 4: Execute the program.

Set the RUN/STOP/REAET switch to reset. The BOOT LED turns on after a boot from the specified memory is completed.

^{*1} Use GX Works2 when the High-speed Universal model QCPU is used.

(2) How to proceed the boot operation of the High Performance model QCPU or Basic model QCPU

Procedure 1: Configure the boot file settings.

Set the names of the files to be booted to the program memory in the Boot file tab of the PLC parameter dialog box.

Procedure 2: Write data to the Standard ROM.

Write the sequence program and parameters to the standard ROM of QCPU using GX Developer.

Procedure 3: Set the switch.

Use dip switches to set Standard ROM as the location to store the parameters.

Procedure 4: Confirm boot operation.

Use the RESET/L.CLR switch to reset.

The BOOT LED turns on after a boot from the specified memory is completed.

APPENDICES

Appendix 1 External Dimensions

For external dimensions of modules shown in this handbook, refer to the user's manual for each module.

Appendix 2 Basic Model QCPU

Basic model QCPU is the best module to realize the cost effectiveness for a small-scale system. For a large-scale system, consider applying the Universal model QCPU/the High Performance model QCPU, which allows you fewer restrictions.

Appendix 2.1 Major restrictions

When the Basic model QCPU is compared to the Universal model QCPU/the High Performance model QCPU, the major restrictions are listed in the following.

(1) Program

- (a) The maximum program capacity is 14K steps (when Q01CPU is selected).
- (b) Program number is limited to 1 respectively for the sequence program (program name: MAIN) and for the SFC program (program name: MAIN - SFC).
- (c) If SFC program has 128th block or later when it is converted, the SFC program is entirely deleted without being converted.

(2) Device

- (a) File register (R) cannot be set for Q00JCPU. Also, for Q00 and Q01CPU, up to 32K points × 2blocks can be set.
- (b) The maximum timer (T)/counter (C) device points are respectively 512. Devices over the maximum points are converted to SM999.
- (c) The maximum latch relay (L) device points are 2048. Devices over the maximum points are converted to SM999.

(3) Comments

- (a) Only comments for each program (MAIN) are converted when the program is replaced.

(4) System configuration

- (a) Number of I/O points, extension base unit number, and module number are shown in the following table.

	Q00JCPU	Q00CPU	Q01CPU	Q02CPU (Reference)	Q02UCPU (Reference)
Number of I/O points	256	1024		4096	2048
Number of extension base units	2 units (Max.)	4 units (Max.)		7 units (Max.)	4 units (Max.)
Number of loaded modules	16 modules (Max.)	24 modules (Max.)		64 modules (Max.)	36 modules (Max.)
Memory card (Number of slots)	Not available.			1 slot	1 slot

- (b) When configured using the Basic model QCPU, only Q series modules must be used for all the modules. Connections of QA1S51B, QA1S6□B, and QA6□B base units are not compliant with the specification, and therefore the I/O and special modules of A/AnS series cannot be used.
- (c) Number of network modules is shown in the following table.

	Q00JCPU	Q00CPU	Q01CPU	Q02CPU (Reference)	Q02UCPU (Reference)
MELSECNET/H	1 module (only PLC to PLC network is available, remote I/O network is not available)			4 modules	4 modules
Ethernet	1 module			4 modules	4 modules
CC-Link*1	2 module			No limit	No limit

*1 There are restrictions on the version of CPU.

For details, please refer to QCPU User's Manual (Hardware Design, Maintenance and Inspection).

Appendix 2.2 CPU module specifications comparison

Function	Contents	AnS/QnAS series				
		AnS(H)CPU	AnUS(H)CPU	QnAS(H)CPU		
Control method	Repetitive operation of stored program	○	○	○		
I/O control method	Refresh mode/Direct mode	○ ^{*1}	△ ^{*2}	△ ^{*2}		
Programming language	Language dedicated to sequence control (Relay symbol, Logic symbol, MELSAP language)	○	○	○		
Processing speed	Sequence instructions (μs/step)	1.0	0.15	0.075		
Watchdog timer (WDT)	Watchdog timer (WDT) (ms)	10 to 2000	200	5 to 2000		
Memory capacity	User memory capacity (bytes)	Max. 448K (Memory cassette)	Max. 1024K (Memory cassette)	Max. 2036K × 2 (SRAM card)		
Program capacity	Sequence program (steps)	Max. 30K × 2	Max. 30K × 4	Max. 124K		
	Microcomputer program (bytes)	Max. 58K	×	×		
Number of occupied I/O points	Number of I/O points (points) ^{*3}	256 to 2048	512 to 4096	512 to 4096		
No. of device points	Input device (X) (points) ^{*4}	256 to 2048	8192	8192		
	Output device (Y) (points) ^{*4}	256 to 2048	8192	8192		
	Internal relay (M) (points)	Total 2048	Total 8192	8192		
	Latch relay (L) (points)			8192		
	Step relay (S) (points)			8192 ^{*5}		
	Annunciator (F) (points)	256	2048	2048		
	Edge relay (V) (points)	×	×	2048		
	Link relay (B) (points)	1024	8192	8192		
	Timer (T) (points)	256	2048	2048		
	Counter (C) (points)	256	1024	1024		
	Data register (D) (points)	1024	8192	12287		
	Link register (W) (points)	1024	8192	8192		
	File register (R) (points)	8192	8192	32768		
	Accumulator (A) (points)	2	2	×		
	Index register	(Z) (points)	1	7	16	
		(V) (points)	1	7	×	
	Nesting (N) (points)	8	8	15		
	Pointer (P) (points)	256	256	4096		
	Special relay (M) (points)	256	256	2048		
Special register (D) (points)	256	256	2048			
Comment points	Comment points (points) ^{*6}	Max. 4032	Max. 4032	Max. approx. 50K		
Self-diagnostics	Watchdog timer (WDT), Memory error detection, CPU error detection, Battery error detection, etc.	○	○	○		
Operation mode at error occurrence	Stop/Continue setting	○	○	○		
Output mode switching at changing from STOP to RUN	Re-output operation status before STOP/Selection of output after operation execution	○	○	○		

*1 Direct I/O is also selectable with the DIP switch.

*2 Basically, only the refresh mode is applicable, but some instructions/devices can be input/output in the direct mode.

*3 This number means the number of applicable points for the access to actual I/O modules.

*4 This number means the number of useable points on the program.

*5 The step relays (S) of the QnAS and Q series are dedicated to the SFC.

*6 Comment points are the points that can be written to CPU.

○ : Usable, △ : Unusable, ×: Partially different in spec. (e.g. setting method)

	Q series Basic model			Precaution for replacement
	Q00JCPU	Q00CPU	Q01CPU	
	○	○	○	–
	△ *2	△ *2	△ *2	Use direct I/O instructions to input/output in the direct mode, as the Q series supports the refresh mode only.
	○	○	○	The MELSAP language for QnAS/Q series supports is MELSAP3 and that for AnS series is MELSAP-II.
	0.2	0.16	0.1	–
	10 to 2000	10 to 2000	10 to 2000	–
	Max. 58K	Max. 94K	Max. 94K	A memory cassette is required for the AnS series as user memory, while the user memory is included in the Q series as standard equipment.
	Max. 8K	Max. 8K	Max. 14K	–
	×	×	×	The AnUS, QnAS and Q series do not include microcomputer program. Therefore, consider use of the sequence program, etc. as the substitution.
	256	1024	1024	–
	2048	2048	2048	–
	2048	2048	2048	–
	8192	8192	8192	–
	2048	2048	2048	–
	2048*5	2048*5	2048*5	–
	1024	1024	1024	–
	1024	1024	1024	–
	2048	2048	2048	–
	512	512	512	–
	512	512	512	–
	11136	11136	11136	–
	2048	2048	2048	–
	×	32768	32768	The Q00JCPU does not have file registers.
	×	×	×	Accumulators are converted to the special registers (SD718, SD719) upon AnS → Q program conversion as they are not included in the QnAS and Q series.
	10	10	10	–
	×	×	×	This is used as an edge relay for the QnAS and Q series.
	15	15	15	–
	300	300	300	–
	1024	1024	1024	–
	1024	1024	1024	–
	Max. 1400	Max. 2300	Max. 2300	–
	○	○	○	–
	○	○	○	–
	○	○	○	–

Appendix 2.3 CPU module functional comparison

(1) Functional comparison between AnSCPU and QCPU

○: Usable △: Unusable ×: Partially different in spec. (e.g. setting method)

Function	Contents	AnS series	Basic model QCPU			Precaution for replacement
		AnS(H) CPU	Q00J CPU	Q00 CPU	Q01 CPU	
Constant scan	Executes the sequence program at constant time intervals regardless of the processing time of the program.	○	△	△	△	Set this function with the special register (D9020) for A series, and with parameters for Q series Basic model.
Latch (power backup)	Holds the data of devices when turning OFF the power, resetting, and a momentary power failure longer than 20ms occurs.	○	○	○	○	-
Remote RUN/STOP	Executes the remote RUN/STOP using the external switches and peripheral devices.	○	○	○	○	-
PAUSE	Stops operations while holding the output status.	○	○	○	○	-
Interrupt processing	Executes the program that corresponds to the cause when an interrupt cause occurs.	○	△	△	△	For AnS series, an interrupt program is required for main program. For Basic model QCPU, create only one interrupt program to share between the two programs.
Microcomputer mode	Executes various controls and operations over utility programs and user created microcomputer programs stored in the microcomputer program area by calling them from the sequence program.	○	×	×	×	Consider use of sequence program, etc., as the substitution.
Control Display of priority of ERROR LED	The settings for ON/OFF of ERROR LED at the occurrence of error.	×	○	○	○	Target errors vary for each module, but there is no functional differences.
ROM operation	Enables operation with parameters and programs stored in ROMs in order not to lose user programs due to battery exhaustion.	○	△	△	△	When performing ROM operation in the Basic model QCPU, use the boot run function to read the sequence programs stored in the standard ROM built in the CPU or memory card into the program memory built in the CPU.
Data protection function (System protect, Keyword registration/ Password registration)	Prohibits peripheral devices from reading/writing to programs and comments in the memory cassettes, the memory card, and built-in memory, etc. of a CPU module.	○	△	△	△	The Basic model QCPU prohibits each file from being read/written by password registration, whereas the AnS series prohibits the parameters and programs from being read/written to the user memory by keyword registration.
The settings of output status at changing from STOP to RUN	The settings for the output status at changing from STOP to RUN (Y) between "re-output operation status before STOP" and "output after operation execution".	○	○	○	○	In case of transition from the AnS series, it is necessary to re-set the parameters.
Clock function	Q CPU includes a clock, of which data can be read and written. The clock data consists of year, month, date, hour, minute, second and a day of the week.	○	△	△	△	The Basic model QCPU handles the four digits of the year (western calendar), whereas the AnS series handles only the last two digits.

○: Usable △: Unusable ×: Partially different in spec. (e.g. setting method)

Function	Contents	AnS series	Basic model QCPU			Precaution for replacement
		AnS(H) CPU	Q00J CPU	Q00 CPU	Q01 CPU	
Debug	Write during RUN	○	○*1	○*1	○*1	For the Basic model QCPU, it is necessary to set the reserved capacity for the write during RUN in advance.
	Status latch	○	×	×	×	The Basic model QCPU does not include the status latch function.
	Sampling trace	○	×	×	×	The Basic model QCPU does not include the sampling trace function.
	Step operation (skip operation partial operation)	○	×	×	×	The Basic model QCPU does not include the step operation function. Consider the debug with GX Simulator.
	Off-line switch	○	×	×	×	The Basic model QCPU does not include the off-line switch function.
Maintenance	Online I/O module replacement	○	×	×	×	The Basic model QCPU does not include the online I/O module replacement function.
	Self-diagnostics function	○	○	○	○	Error codes differ between the AnS series and Q series Basic model.

*1 It is necessary to set the reserved capacity for the write during RUN in advance. (Default-set to 500 steps.)

(2) Functional comparisons between AnUS(H)CPU and QCPU

O: Usable Δ: Unusable x: Partially different in spec. (e.g. setting method)

Function	Contents	AnS series	Basic model QCPU			Precaution for replacement	
		AnUS(H) CPU	Q00J CPU	Q00 CPU	Q01 CPU		
Control	Constant scan	Executes the sequence program at constant time intervals regardless of the processing time of the program.	○	△	△	△	Set this function with the special register (D9020) for the AnS series, and with parameters for the Basic model QCPU.
	Latch (power backup)	Holds the data of devices when turning OFF the power, resetting, and a momentary power failure longer than 20ms occurs.	○	○	○	○	—
	Remote RUN/STOP	Executes the remote RUN/STOP using the external switches and peripheral devices.	○	○	○	○	—
	PAUSE	Stops operations while holding the output status.	○	○	○	○	—
	Interrupt processing	Executes the program that corresponds to the cause when an interrupt cause occurs.	○	△	△	△	For AnS series, an interrupt program is required for main program. For Basic model QCPU, create only one interrupt program to share between the two programs.
	Display of priority of ERROR LED	The settings for ON/OFF of ERROR LED at the occurrence of error.	○	○	○	○	Target errors vary for each module, but there is no functional differences.
	ROM operation	Enables operation with parameters and programs stored in ROMs in order not to lose user programs due to battery exhaustion.	○	△	△	△	When performing ROM operation in the Basic model QCPU, use the boot run function to read the sequence programs stored in the standard ROM built in the CPU or memory card into the program memory built in the CPU.
	Data protection function (System protect, Keyword registration/ Password registration)	Prohibits peripheral devices from reading/writing to programs and comments in the memory cassettes, the memory card, and built-in memory, etc. of a CPU module.	○	△	△	△	The Basic model QCPU prohibits each file from being read/written by password registration, whereas the AnS series prohibits the parameters and programs from being read/written to the user memory by keyword registration.
	The settings of output status at changing from STOP to RUN	The settings for the output status at changing from STOP to RUN (Y) between "re-output operation status before STOP" and "output after operation execution".	○	○	○	○	Resetting parameters is required to replace the AnS series with the Basic model QCPU.
Clock function	Q CPU includes a clock, of which data can be read and written. The clock data consists of year, month, date, hour, minute, second and a day of the week.	○	△	△	△	The Basic model QCPU handles the four digits of the year (western calendar), whereas the AnS series handles only the last two digits.	

○: Usable △: Unusable ×: Partially different in spec. (e.g. setting method)

Function	Contents	A series	Basic model QCPU			Precaution for replacement
		AnUS(H) CPU	Q00J CPU	Q00 CPU	Q01 CPU	
Debug	Write during RUN	○	○*1	○*1	○*1	For the Basic model QCPU, it is necessary to set the reserved capacity for the write during RUN in advance.
	Status latch	○	×	×	×	The Basic model QCPU does not include the status latch function.
	Sampling trace	○	×	×	×	The Basic model QCPU does not include the sampling trace function.
	Step operation (skip operation partial operation)	○	×	×	×	The Basic model QCPU does not include the step operation function. Consider the debug with GX Simulator.
Maintenance	Online I/O module replacement	○	×	×	×	The Basic model QCPU does not include the online I/O module replacement function.
	Self-diagnostics function	○	○	○	○	Error codes differ between the AnS series and Basic model QCPU.
	Error history	○	○	○	○	Error codes differ between the AnS series and Basic model QCPU. The latest 16 points are stored in the error history storage memory.

*1 It is necessary to set the reserved capacity for the write during RUN in advance. (Default-set to 500 steps.)

(3) Functional comparisons between QnASCPU and QCPU

○: Usable △: Unusable ×: Partially different in spec. (e.g. setting method)

Function	Contents	QnAS series	Basic model QCPU			Precaution for replacement
		QnAS(H) CPU	Q00J CPU	Q00 CPU	Q01 CPU	
Constant scan	Executes the sequence program at the constant time intervals regardless of the processing time of the program.	○	○	○	○	-
Latch (power backup)	Holds the data of devices when turning OFF the power, resetting, and a momentary power failure longer than 20ms occurs.	○	○	○	○	-
Remote RUN/STOP	Executes the remote RUN/STOP using the external switches and peripheral devices.	○	○	○	○	-
PAUSE	Stops operations while holding the output status.	○	○	○	○	-
Interrupt processing	Executes the program that corresponds to the cause when an interrupt cause occurs.	○	△	△	△	For QnAS series, an interrupt program is required for main program. For Basic model QCPU, create only one interrupt program to share between the two programs.
Display priority of ERROR LED	The settings for ON/OFF of ERROR LED at the occurrence of error.	○	○	○	○	Target errors vary for each model, but there are no functional differences.
File management	Manages all of parameters, sequence programs, device comments, file registers, etc. as files.	○	○	○	○	Only one file can be created for each file.
Structured program	Selects a suitable execution type for program application, and divides each program by designer, process or others.	○	×	×	×	For the Basic model QCPU, only one ladder program and SFC program is respectively available. Set all execution type to "Scan".
I/O assignment	Performs the I/O assignments to any individual module regardless of its mounted position.	○	△	△	△	When using a base unit with other than 8 slots, set the number of slots with the parameter (I/O assignment setting).
Boot run (ROM operation)	Executes the sequence program after reading it from the memory card to the CPU built-in memory when the CPU goes to RUN mode.	○	△	△	△	For the Basic model QCPU, the boot run can be executed with the standard ROM built in the CPU but not with the memory card.
Data protection function (System protect, Keyword registration/ Password registration)	Prohibits peripheral devices from reading/writing to programs and comments in the memory cassettes, the memory card, and built-in memory, etc. of a CPU module.	○	△	△	△	The Basic model QCPU prohibits each file from being read/written by password registration, whereas the QnAS series prohibits the parameters and programs from being read/written to the user memory by keyword registration.
Device default value	Sets the default value into the device memory, file register, special function module, etc. when the CPU is changing from STOP to RUN.	○	○	○	○	-
The settings of output status at changing from STOP to RUN	The settings for the output status at changing from STOP to RUN (Y) between "re-output operation status before STOP" and "output after operation execution".	○	○	○	○	Resetting parameters is required to replace the QnAS series with the Basic model QCPU.
Number of general data processing	Sets the number of general data processing executed in one END operation.	○	△	△	△	For the Basic model QCPU, use COM instructions or set the communication reserved time with special register (SD315) if necessary.
Clock function	Q CPU incorporates a clock, which can be read/written. The clock data consists of year, month, day, hour, minute, second and a day of the week.	○	△	△	△	The Basic model QCPU handles the four digits of the year (western calendar), whereas the QnAS series handles only the last two digits.

○: Usable △: Unusable ×: Partially different in spec. (e.g. setting method)

Function	Contents	QnAS series	Basic model QCPU			Precaution for replacement
		QnAS(H) CPU	Q00J CPU	Q00 CPU	Q01 CPU	
Debug	Write during RUN	○ *1	○ *1	○ *1	○ *1	For the Basic model QCPU, it is necessary to set the reserved capacity for the write during RUN in advance.
	Status latch	○	×	×	×	The Basic model QCPU does not include the status latch function.
	Sampling trace	○ *2	×	×	×	The Basic model QCPU does not include the sampling trace function.
	Program trace	○ *2 *3	×	×	×	The Basic model QCPU does not include the program trace function.
	Simulation function	○ *3	×	×	×	The Basic model QCPU does not include the simulation function. Consider the debug with GX Simulator.
	Step operation (Skip operation partial operation)	○	×	×	×	The Basic model QCPU does not include the step operation function. Consider the debug with GX Simulator.
	Execution time measurement (Program list monitor, scan time measurement)	○	○	○	○	—
	Module access interval time reading	○	×	×	×	The Basic model QCPU does not include this function.
Maintenance	Online I/O module replacement	○	×	×	×	The Basic model QCPU does not include the online I/O module replacement function.
	Self-diagnostics	○	○	○	○	Error codes differ between the QnAS series and Q series Basic model.
	Error history	○	○	○	○	Error codes differ between the QnAS series and Basic model QCPU. The latest 16 points are stored in the error history storage memory.

*1 It is necessary to set the reserved capacity for the write during RUN in advance. (Default-set to 500 steps.)

*2 The SRAM card is required.

*3 GPPQ is required. This is not applicable to GX Developer.

Appendix 3 Spare Parts Storage

- (1) The general specifications of programmable controllers are as follows. Please do not store spare parts under a high temperature or high humidity condition, even within the range guaranteed by the specifications.

Storage ambient temperature	-20 to 75°C
Storage ambient humidity	10 to 90%, no condensation

- (2) Store in a place avoiding direct sunlight.
- (3) Store under a condition with no dust or corrosive gas.
- (4) The battery capacity of a A6BAT battery or a lithium-coin battery (commercially available) for memory card will be decreased by its self-discharging even when it is not used. Replace it with new one in 5 years as a guideline.
- (5) For a power supply module, CPU module with built-in power supply, or analog module that uses any aluminum electrolytic capacitor, which is indicated in the table below, take the following measures since the characteristics will be deteriorated when the aluminum electrolytic capacitor is left un-energized for a long time.

Product	Model (AnS series)
CPU module (Power supply built-in type)	A1SJHCPU
Power supply module	A1S61PN, A1S62ON, A1S63P
Analog module	A1S64AD, A1S68AD, A1S62DA, A1S68DAI, A1S68DAV, A1S63ADA, A1S66ADA

[Countermeasures for preventing aluminum electrolytic capacitor characteristics deterioration]

Apply the rated voltage to the aluminum electrolytic capacitor for several hours to activate it. Or, rotate products at the periodic inspection (in every 1 to 2 years).

[Reference]

The life of an aluminum electrolytic capacitor, even if not used, under a normal temperature decreases approximately at 1/4 speed of the case when it is energized.

Appendix 4 Related Manuals

Appendix 4.1 Materials for replacement

(1) Renewal catalogue

No.	Manual Name	Manual Number	Target	
			A (large)	AnS (small)
1	MELSEC-A/QnA Series Transition Guide	L08077E	○	×
2	MELSEC-AnS/QnAS (Small Type) Series Transition Guide	L08236E	×	○

(2) Handbook for transition

No.	Manual Name	Manual Number	Target	
			A (large)	AnS (small)
1	Transition from MELSEC-A/QnA (Large Type) Series to Q Series Handbook (Fundamentals)	L08043ENG	○	×
	Transition from MELSEC-AnS/QnAS (Small Type) Series to Q Series Handbook (Fundamentals)	L08219ENG	×	○
	Transition from MELSEC-AnS/QnAS (Small Type) Series to L Series Handbook (Fundamentals)	L-08258ENG	×	○
2	Transition from MELSEC-A/QnA (Large Type) Series to Q Series Handbook (Intelligent Function Modules)	L08046ENG	○	×
	Transition from MELSEC-AnS/QnAS (Small Type) Series to Q Series Handbook (Intelligent Function Modules)	L08220ENG	×	○
	Transition from MELSEC-AnS/QnAS (Small Type) Series to L Series Handbook (Intelligent Function Modules)	L-08259ENG	×	○
3	Transition from MELSEC-A/QnA (Large Type), AnS/QnAS (Small Type) Series to Q Series Handbook (Network Modules)	L08048ENG	○	○
	Transition from MELSEC-AnS/QnAS (Small Type) Series to L Series Handbook (Network Modules)	L-08260ENG	×	○
4	Transition from MELSEC-A/QnA (Large Type), AnS/QnAS (Small Type) Series to Q Series Handbook (Communications)	L08050ENG	○	○
	Transition from MELSEC-AnS/QnAS (Small Type) Series to L Series Handbook (Communications)	L-08261ENG	×	○
5	Transition from MELSEC-A0J2H Series to Q Series Handbook	L08060ENG	○	○
6	Transition from MELSECNET/MINI-S3, A2C(I/O) to CC-Link Handbook	L08061ENG	○	○
7	Transition from MELSEC-I/OLINK to CC-Link/LT Handbook	L08062ENG	○	○
8	Transition from MELSEC-I/OLINK to AnyWire DB A20 Handbook	L08263ENG	○	○
9	Transition of CPUs in MELSEC Redundant System Handbook (Transition from Q4ARCPU to QnPRHCPU)	L08117ENG	○	×

(3) Renewal examples

No.	Manual Name	Manual Number	Target	
			A (large)	AnS (small)
1	MELSEC-A/QnA (Large), AnS/QnAS (Small) Transition Examples	L08121E	○	○

(4) Others

No.	Manual Name (TECHNICAL BULLETIN)	Manual Number	Target	
			A (large)	AnS (small)
1	Procedures for Replacing Positioning Module AD71 with QD75	FA-A-0060	○	○
2	Precautions for replacing A/QnA (large type) series CPU with Universal model QCPU	FA-A-0068	○	×

Appendix 4.2 AnS/QnAS series

No.	Manual Name	Manual Number	Model Code
1	Type A1S/A1SC24-R2/A2SCPU(S1) User's Manual	IB-66320	13J672
2	Type A1SJH(S8)/A1SH/A2SHCPU (S1) User's Manual	IB-66779	13JL22
3	Type A2USCPU(S1) User's Manual	IB-66536	13JE78
4	Type A2USHCPU-S1/A2USCPU(S1)/A2ASCPU(S1/S30) User's Manual	IB-66789	13JL30
5	Model Q2AS(H)CPU (S1) User's Manual	SH-3599	13J858
6	Type ACPUCPU/QCPU-A (A Mode) (Fundamentals) Programming Manual	IB-66249	13J740
7	Type ACPUCPU/QCPU-A (A Mode) (Common Instructions) Programming Manual	IB-66250	13J741
8	Type AnSHCPU/AnACPU/AnUCPU/QCPU-A (A Mode) Programming Manual (Dedicated Instructions)	IB-66251	13J742
9	Type AnACPU/AnUCPU/QCPU-A (A mode) Programming Manual (PID Control Instructions)	IB-66258	13J744
10	Type MELSAP-II(SFC) Programming Manual	IB-66361	13JF40
11	QnACPU Programming Manual (Fundamentals)	IB-66614	13JF46
12	QnACPU Programming Manual (Special Function Module)	SH-4013	13JF56
13	QCPU(Q Mode)/QnACPU Programming Manual (Common Instructions)	SH-080039	13JF58
14	QCPU(Q Mode)/QnACPU Programming Manual (PID Control Instructions)	SH-080040	13JF59
15	QCPU(Q Mode)/QnACPU Programming Manual (SFC)	SH-080041	13JF60
16	I/O module type Building block User's Manual	IB-66140	13J643
17	Computer Link Module (Com.link func./Print. func.) User's Manual	SH-3511	13JF77
18	Serial Communications Module User's Manual (Modem Function Additional Version)	SH-66612	13J825
19	For A Ethernet Interface Module User's Manual	SH-080192	13JR45
20	For QnA Ethernet Interface Module User's Manual	SH-080146	13JR33
21	Type A1SD51S Intelligent communication module User's Manual	IB-66551	13JE90
22	AD51H-BASIC Programming Manual (Debug and Compile)	SH-080091	13JF64
23	AD51H-BASIC Programming Manual (Command)	SH-080090	13JF63
24	Control & Communication Link System Master/Local Module Type AJ61BT11/A1SJ61BT11 User's Manual	IB-66721	13J872
25	Control & Communication Link System Master/Local Module type AJ61QBT11/A1SJ61QBT11 User's Manual	IB-66722	13J873
26	A/D converter module type A1S64AD User's Manual	IB-66336	13J676
27	Analog-Digital Converter Module type A1S68AD User's Manual	IB-66576	13J757
28	D/A converter module type A1S62DA User's Manual	IB-66335	13J673
29	Digital-Analog Converter Module Type A1S68DAV/DAI User's Manual	IB-66587	13J810
30	Thermocouple input module type A1S68TD User's Manual	IB-66571	13J781
31	Type A68RD3N/4N,A1S62RD3N/4N Pt100 Input Module User's Manual	SH-080193	13JR46
32	A1S62TCTT-S2 Heating-Cooling Temperature Control Module A1S62TCTTBW-S2 Heating-Cooling Temperature Control Module with Wire Breakage Detection Function User's Manual	SH-3643	13JL35
33	A1S62TCRT-S2 Heating-Cooling Temperature Control Module A1S62TCRTBW-S2 Heating-Cooling Temperature Control Module with Wire Breakage Detection Function User's Manual	SH-3644	13JL36
34	Temperature Control Module Type A1S64TCTRT/Temperature Control Module with Disconnection Detection Function Type A1S64TCTRTBW User's Manual	SH-080549ENG	13JR79
35	A1S64TCRT-S1 Temperature Control Module A1S64TCRTBW-S1 Temperature Control Module with Disconnection Detection Function User's Manual	IB-66756	13JL03

No.	Manual Name	Manual Number	Model Code
36	A1S64TCTT-S1 Temperature Control Module/A1S64TCTTBW-S1 Temperature Control Module with Disconnection Detection Function User's Manual	IB-66747	13J891
37	Positioning module type A1SD70 User's Manual	IB-66367	13JE04
38	A1SD75M1/M2/M3, AD75M1/M2/M3 Positioning module User's Manual	IB-66715	13J870
39	A1SD75P1-S3/P2-S3/P3-S3, AD75P1-S3/P2-S3/P3-S3 Positioning Module User's Manual	IB-66716	13J871
40	Type A1S62LS User's Manual	IB-66647	13J837
41	High speed counter module type A1SD61 User's Manual	IB-66337	13J674
42	High speed counter module Type A1SD62, A1SD62E, A1SD62D(S1) User's Manual	IB-66593	13J816
43	Pulse catch module type A1SP60 (Hardware) User's Manual	IB-66477	13JE61
44	Analog timer module type A1ST60 (Hardware) User's Manual	IB-66479	13JE57
45	Analog input/output module type A1S63ADA User's Manual	IB-66435	13JE30
46	Analog Input/Output Module Type A1S66ADA User's Manual	IB-66819	13JL41
47	MELSECNET/MINI-S3 Master Module Type AJ71PT32-S3, AJ71T32-S3, A1SJ71PT32-S3, A1SJ71T32-S3 User's Manual	IB-66565	13JE64
48	AS-i Master module type A1SJ71AS92 User's Manual	SH-080085	13JR15
49	A1SD59J-S2/MIF Memory Card Interface Module User's Manual	SH-080056	13JR05

Appendix 4.3 Q series

No.	Manual Name	Manual Number	Model Code
1	MELSEC-Q Series [QnU]	L08101E	–
2	QCPU User's Manual (Hardware Design, Maintenance and Inspection)	SH-080483ENG	13JP73
3	QnUCPU User's Manual (Function Explanation, Program Fundamentals)	SH-080807ENG	13JZ27
4	Qn(H)/QnPH/QnPRHCPU User's Manual (Function Explanation, Program Fundamentals)	SH-080808ENG	13JZ28
5	MELSEC-Q/L Programming Manual (Common Instructions)	SH-080809ENG	13JW10
6	MELSEC-Q/L/QnA Programming Manual (PID Control Instructions)	SH-080040	13JF59
7	MELSEC-Q/L/QnA Programming Manual (SFC)	SH-080041	13JF60
8	QA65B/QA68B Extension Base Unit User's Manual	IB-0800158	13JR26
9	I/O Module Type Building Block User's Manual	SH-080042	13JL99
10	Spring Clamp Terminal Block Model Q6TE-18S User's manual	IB-0800204E	13JT72
11	Insulation Displacement Connector for MELSEC-Q Series 32-Point I/O Module User's Manual	IB-0800228E	13JT92
12	Analog-Digital Converter Module User's Manual	SH-080055	13JR03
13	Channel Isolated High Resolution Analog-Digital Converter Module /Channel Isolated High Resolution Analog-Digital Converter Module (With Signal Conditioning Function) User's Manual Q64AD-GH/Q62AD-DGH/GX Configurator-AD (SW2D5C-QADU-E)	SH-080277	13JR51
14	Channel Isolated Analog-Digital Converter Module/Channel Isolated Analog-Digital Converter Module (With Signal Conditioning Function) User's Manual Q68AD-H/Q66AD-DG/GX Configurator-AD (SW2D5C-QADU-E)	SH-080647ENG	13JR96
15	Digital-Analog Converter Module User's Manual	SH-080054	13JR02
16	Channel Isolated Digital-Analog Converter Module User's Manual (Q62DA-FG/SW2D5C-QDAU-E)	SH-080281E	13JR52
17	Channel Isolated Digital-Analog Converter Module User's Manual (Q66DA-G/SW2D5C-QDAU-E)	SH-080648ENG	13JR97
18	Analog Input/Output Module User's Manual Q64AD2DA	SH-080793ENG	13JZ25
19	RTD Input Module Channel Isolated RTD Input Module User's Manual	SH-080142	13JR31
20	Channel Isolated RTD Input Module User's Manual Q68RD3-G/GX Configurator-TI	SH-080722ENG	13JZ06
21	Thermocouple Input Module Channel Isolated Thermocouple/Micro Voltage Input Module User's Manual	SH-080141	13JR30
22	Channel Isolated Thermocouple Input Module User's Manual Q68TD-G-H01/Q68TD-G-H02/GX Configurator-TI (SW1D5C-QTIU-E)	SH-080795ENG	13JZ26
23	Temperature Control Module User's Manual	SH-080121	13JR21
24	High-Speed Counter Module User's Manual	SH-080036	13JL95
25	High-Speed Counter Module User's Manual	SH-080036	13JL95
26	Type QD75P/QD75D Positioning Module User's Manual	SH-080058	13JR09
27	User's Manual Type QD75M Positioning Module (Details)	IB-0300062	ICT752
28	Q Corresponding Serial Communication Module User's Manual (Basic)	SH-080006	13JL86
29	MELSEC-Q/L Serial Communication Module User's Manual (Application)	SH-080007	13JL87
30	MELSEC-Q/L MELSEC Communication Protocol Reference Manual	SH-080008	13JF89
31	Q Corresponding Ethernet Interface Module User's Manual (Basic)	SH-080009	13JL88
32	Q Corresponding Ethernet Interface Module User's Manual (Application)	SH-080010	13JL89
33	Q Corresponding Intelligent Communication Module User's Manual	SH-080089	13JR16
34	AD51H-BASIC Programming Manual (Command)	SH-080090	13JF63
35	AD51H-BASIC Programming Manual (Debug and Compile)	SH-080091	13JF64
36	CC-Link System Master/Local Module User's Manual QJ61BT11N	SH-080394E	13JR64
37	Q Corresponding MELSECNET/H Network System Reference Manual (PLC to PLC network)	SH-080049	13JF92

No.	Manual Name	Manual Number	Model Code
38	Q Corresponding MELSECNET/H Network System Reference Manual (Remote I/O network)	SH-080124	13JF96
39	CC-Link/LT Master Module User's Manual	SH-080351E	13JR62
40	MELSECNET, MELSECNET/B Local Station Data Link Module User's Manual	SH-080670ENG	13JR98
41	MELSEC-Q QD73A1 Positioning Module User's Manual	SH-081075ENG	13JZ69
42	MELSEC-Q/L AnyWire DB A20 Master Module User's Manual	SH-080968ENG	13JZ52

Appendix 4.4 Programming tool

No.	Manual Name	Manual Number	Model Code
1	GX Developer Version 8 Operating Manual	SH-080373E	13JU41
2	GX Developer Version 8 Operating Manual (SFC)	SH-080374E	13JU42
3	GX Simulator Version 6 Operating Manual	SH-080169	13JU17
4	GX Works2 Version 1 Operating Manual (Common)	SH-080779ENG	13JU63
5	Type SW4IVD-GPPA (GPP) Operating Manual	IB-66855	13JL62

Appendix 4.5 Products manufactured by Mitsubishi Electric Engineering Co., Ltd.

No.	Catalog name	Catalog Number
1	Mitsubishi Programmable Controller Upgrade Tool	SAN C033E·04Z

Appendix 4.6 Products manufactured by Mitsubishi Electric System & Service Co., Ltd.

No.	Data/catalog	Number
1	Renewal tool for A0J2 series Transition from MELSEC-A0J2(H) series to renewal system using renewal tool	X903071003
2	Replace A0J2(H) system with Q series using existing wiring!	X900707-115

WARRANTY

Please confirm the following product warranty details before using this product.

1. Gratis Warranty Term and Gratis Warranty Range

If any faults or defects (hereinafter "Failure") found to be the responsibility of Mitsubishi occurs during use of the product within the gratis warranty term, the product shall be repaired at no cost via the sales representative or Mitsubishi Service Company.

However, if repairs are required onsite at domestic or overseas location, expenses to send an engineer will be solely at the customer's discretion. Mitsubishi shall not be held responsible for any re-commissioning, maintenance, or testing on-site that involves replacement of the failed module.

[Gratis Warranty Term]

The gratis warranty term of the product shall be for one year after the date of purchase or delivery to a designated place.

Note that after manufacture and shipment from Mitsubishi, the maximum distribution period shall be six (6) months, and the longest gratis warranty term after manufacturing shall be eighteen (18) months. The gratis warranty term of repair parts shall not exceed the gratis warranty term before repairs.

[Gratis Warranty Range]

- (1) The range shall be limited to normal use within the usage state, usage methods and usage environment, etc., which follow the conditions and precautions, etc., given in the instruction manual, user's manual and caution labels on the product.
- (2) Even within the gratis warranty term, repairs shall be charged for in the following cases.
 1. Failure occurring from inappropriate storage or handling, carelessness or negligence by the user. Failure caused by the user's hardware or software design.
 2. Failure caused by unapproved modifications, etc., to the product by the user.
 3. When the Mitsubishi product is assembled into a user's device, Failure that could have been avoided if functions or structures, judged as necessary in the legal safety measures the user's device is subject to or as necessary by industry standards, had been provided.
 4. Failure that could have been avoided if consumable parts (battery, backlight, fuse, etc.) designated in the instruction manual had been correctly serviced or replaced.
 5. Failure caused by external irresistible forces such as fires or abnormal voltages, and Failure caused by force majeure such as earthquakes, lightning, wind and water damage.
 6. Failure caused by reasons unpredictable by scientific technology standards at time of shipment from Mitsubishi.
 7. Any other failure found not to be the responsibility of Mitsubishi or that admitted not to be so by the user.

2. Onerous repair term after discontinuation of production

- (1) Mitsubishi shall accept onerous product repairs for seven (7) years after production of the product is discontinued.

Discontinuation of production shall be notified with Mitsubishi Technical Bulletins, etc.
- (2) Product supply (including repair parts) is not available after production is discontinued.

3. Overseas service

Overseas, repairs shall be accepted by Mitsubishi's local overseas FA Center. Note that the repair conditions at each FA Center may differ.

4. Exclusion of loss in opportunity and secondary loss from warranty liability

Regardless of the gratis warranty term, Mitsubishi shall not be liable for compensation of damages caused by any cause found not to be the responsibility of Mitsubishi, loss in opportunity, lost profits incurred to the user by Failures of Mitsubishi products, special damages and secondary damages whether foreseeable or not, compensation for accidents, and compensation for damages to products other than Mitsubishi products, replacement by the user, maintenance of on-site equipment, start-up test run and other tasks.

5. Changes in product specifications

The specifications given in the catalogs, manuals or technical documents are subject to change without prior notice.

Ethernet is a trademark of Xerox Corp.

All other company names and product names used in this manual are either trademarks or registered trademarks of their respective companies.

Mitsubishi Programmable Controller

Country/Region	Sales office	Tel/Fax
USA	MITSUBISHI ELECTRIC AUTOMATION, INC. 500 Corporate Woods Parkway, Vernon Hills, IL 60061, U.S.A.	Tel : +1-847-478-2100 Fax : +1-847-478-2253
Mexico	MITSUBISHI ELECTRIC AUTOMATION, INC. Mexico Branch Mariano Escobedo #69, Col. Zona Industrial, Tlalnepantla Edo, C.P.54030, Mexico	Tel : +52-55-3067-7500
Brazil	MITSUBISHI ELECTRIC DO BRASIL COMÉRCIO E SERVIÇOS LTDA. Rua Jussara, 1750-Bloco B Anexo, Jardim Santa Cecilia, CEP 06465-070, Barueri-SP, Brasil	Tel : +55-11-4689-3000 Fax : +55-11-4689-3016
Germany	MITSUBISHI ELECTRIC EUROPE B.V. German Branch Gothaer Strasse 8, D-40880 Ratingen, Germany	Tel : +49-2102-486-0 Fax : +49-2102-486-1120
UK	MITSUBISHI ELECTRIC EUROPE B.V. UK Branch Travellers Lane, Hatfield, Hertfordshire, AL10 8XB, U.K.	Tel : +44-1707-28-8780 Fax : +44-1707-27-8695
Ireland	MITSUBISHI ELECTRIC EUROPE B.V. Irish Branch Westgate Business Park, Ballymount, IRL-Dublin 24, Ireland	Tel : +353-1-4198800 Fax : +353-1-4198890
Italy	MITSUBISHI ELECTRIC EUROPE B.V. Italian Branch Centro Direzionale Colleoni-Palazzo Sirio Viale Colleoni 7, 20864 Agrate Brianza(Milano) Italy	Tel : +39-039-60531 Fax : +39-039-6053-312
Spain	MITSUBISHI ELECTRIC EUROPE, B.V. Spanish Branch Carretera de Rubí, 76-80-Apdo. 420, 08173 Sant Cugat del Vallés (Barcelona), Spain	Tel : +34-935-65-3131 Fax : +34-935-89-1579
France	MITSUBISHI ELECTRIC EUROPE B.V. French Branch 25, Boulevard des Bouvets, F-92741 Nanterre Cedex, France	Tel : +33-1-55-68-55-68 Fax : +33-1-55-68-57-57
Czech Republic	MITSUBISHI ELECTRIC EUROPE B.V. Czech Branch Avenir Business Park, Radlicka 751/113e, 158 00 Praha5, Czech Republic	Tel : +420-251-551-470 Fax : +420-251-551-471
Poland	MITSUBISHI ELECTRIC EUROPE B.V. Polish Branch ul. Krakowska 50, 32-083 Balice, Poland	Tel : +48-12-630-47-00 Fax : +48-12-630-47-01
Sweden	MITSUBISHI ELECTRIC EUROPE B.V. (Scandinavia) Fjellievägen 8, SE-22736 Lund, Sweden	Tel : +46-8-625-10-00 Fax : +46-46-39-70-18
Russia	MITSUBISHI ELECTRIC EUROPE B.V. Russian Branch St. Petersburg office Piskarevsky pr. 2, bld 2, lit "Sch", BC "Benua", office 720; RU-195027 St. Petersburg, Russia	Tel : +7-812-633-3497 Fax : +7-812-633-3499
Turkey	MITSUBISHI ELECTRIC TURKEY A. Ş Ümraniye Branch Serifali Mahallesi Nutuk Sokak No:5, TR-34775 Umraniye, Istanbul, Turkey	Tel : +90-216-526-3990 Fax : +90-216-526-3995
Dubai	MITSUBISHI ELECTRIC EUROPE B.V. Dubai Branch Dubai Silicon Oasis, P.O.BOX 341241, Dubai, U.A.E.	Tel : +971-4-3724716 Fax : +971-4-3724721
South Africa	ADROIT TECHNOLOGIES 20 Waterford Office Park, 189 Witkoppen Road, Fourways, Johannesburg, South Africa	Tel : +27-11-658-8100 Fax : +27-11-658-8101
China	MITSUBISHI ELECTRIC AUTOMATION (CHINA) LTD. No.1386 Hongqiao Road, Mitsubishi Electric Automation Center, Shanghai, China	Tel : +86-21-2322-3030 Fax : +86-21-2322-3000
Taiwan	SETSUYO ENTERPRISE CO., LTD. 6F, No.105, Wugong 3rd Road, Wugu District, New Taipei City 24889, Taiwan, R.O.C.	Tel : +886-2-2299-2499 Fax : +886-2-2299-2509
Korea	MITSUBISHI ELECTRIC AUTOMATION KOREA CO., LTD. 7F-9F, Gangseo Hangang Xi-tower A, 401, Yangcheon-ro, Gangseo-Gu, Seoul 157-801, Korea	Tel : +82-2-3660-9530 Fax : +82-2-3664-8372
Singapore	MITSUBISHI ELECTRIC ASIA PTE. LTD. 307, Alexandra Road, Mitsubishi Electric Building, Singapore 159943	Tel : +65-6473-2308 Fax : +65-6476-7439
Thailand	MITSUBISHI ELECTRIC FACTORY AUTOMATION (THAILAND) CO., LTD. 12th Floor, SV.City Building, Office Tower 1, No. 896/19 and 20 Rama 3 Road, Kwaeng Bangpongpan, Khet Yannawa, Bangkok 10120, Thailand	Tel : +66-2682-6522 Fax : +66-2682-6020
Vietnam	MITSUBISHI ELECTRIC VIETNAM COMPANY LIMITED Hanoi Branch 6-Floor, Detech Tower, 8 Ton That Thuyet Street, My Dinh 2 Ward, Nam Tu Liem District, Hanoi, Vietnam	Tel : +84-4-3937-8075 Fax : +84-4-3937-8076
Indonesia	PT. MITSUBISHI ELECTRIC INDONESIA Gedung Jaya 11th Floor, JL. MH. Thamrin No.12, Jakarta Pusat 10340, Indonesia	Tel : +62-21-3192-6461 Fax : +62-21-3192-3942
India	MITSUBISHI ELECTRIC INDIA PVT. LTD. Pune Branch Emerald House, EL-3, J Block, M.I.D.C Bhosari, Pune-411026, Maharashtra, India	Tel : +91-20-2710-2000 Fax : +91-20-2710-2100
Australia	MITSUBISHI ELECTRIC AUSTRALIA PTY. LTD. 348 Victoria Road, P.O. Box 11, Rydalmere, N.S.W 2116, Australia	Tel : +61-2-9684-7777 Fax : +61-2-9684-7245

Mitsubishi Electric Corporation Nagoya Works is a factory certified for ISO 14001 (standards for environmental management systems) and ISO 9001 (standards for quality assurance management systems)

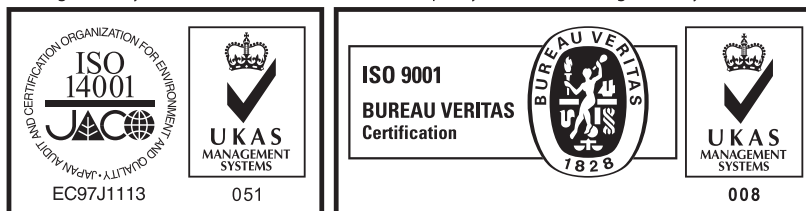

MITSUBISHI ELECTRIC CORPORATION

HEAD OFFICE: TOKYO BUILDING, 2-7-3, MARUNOUCHI, CHIYODA-KU, TOKYO 100-8310, JAPAN
NAGOYA WORKS: 1-14, YADA-MINAMI 5, HIGASHI-KU, NAGOYA, JAPAN